

TECH NOTE :: QuantumX Data Recorder and GPS / GNS / IMU

Mobile data acquisition including position and map based analysis

Version: 2016-07-29

Author: Christof Salcher

Status: **public**



Abstract

This Tech Note describes **satellite based position measurement** in general and its value in mobile data acquisition and analysis, helpful in many different applications and industries. It describes different **sensors** and **Inertial Measurement Units (IMU)** and the HBM tool chain **QuantumX** data acquisition system, **catman** and **GlyphWorks** for post-process data analysis.

Intro

When developing ground vehicles, aircrafts or any other moving machine function, performance, durability / reliability, comfort and safety needs to be assured and tested. Many conditions can be tested in labs with simulated environment. True field tests still have a high priority and prototypes need to be tested in many different conditions, manoeuvres, special exceptions or environmental influences like bad roads to chassis and components of a vehicle.

The trend in state-of-the art data recording is towards sensor and **data fusion** with a single recorder acquiring additionally installed high quality **sensors, transducers, digital bus signal** from on-board electronics, **video** camera and satellite based **position** data.

The acquired data in return is used for many purposes:

- Verify or certify an overall system
- Tracking faults or behaviour in certain use or load cases and field trials
- Improve lab based testing
- Improve computer based simulation and testing
 - o Multi body simulation for further dynamics analysis
 - o Fatigue simulation for reliability and life-time testing
 - o Functional control and plant model engineering
- Comparing results with existing products already established in the market

[QuantumX](#) Data Recorder CX22B-W is a perfect tool for mobile data acquisition. The different analog frontends can be easily connected via a single cable allowing all kind of sensors to be acquired like strain, pressure, acceleration, torque, force, temperature, displacement, voltage, current and many more in addition to digital bus signals. In addition to that position based sensors or IMU's enables engineers to easily correlate all measured data to a geographical position visualized in a map or certain track.

What is GPS/GNS?

GPS stands for **G**lobal **P**ositioning **S**ystem and is originally based on the US satellite system **NAVSTAR**. The system from Russia is called **GLONASS** (short: GNS or GNSS) which stands for **G**LObalnaja **N**awigazionnaja **S**putnikowaja **S**istema is also open for public use. The system from the European Union is called **GALILEO** which is not yet in full operation. China is also working on a satellite based geographical localization system called **COMPASS** (BeiDu-2 navigation system) which is not yet in operation. In the following we keep it short and just write GPS.

A GPS sensor receives basically the following information from satellites circling around the orbit:

- position in x, y and z axis (longitude, latitude and altitude)
- time (some sensor have a direct PPS signal output, an encoded time signal)
- number of visible satellites

GPS is used to precisely calculate latitude and longitude of a specific position. The GPS system is based on a network of many satellites that orbit the earth twice every 24 hours. The precise orbit of the satellites and their use of very accurate clocks allow precise triangulation of a vehicles or users position. Each satellite transmits its exact position and a very accurate time. The accurate time required for GPS is provided by atomic clocks at the U.S. Naval Observatory to the satellite system, so that the complete system works fully synchronised.

At the moment GPS sensors need a clear view to the sky, for example mounted on the roof top of a vehicle with a 360° view to the sky to get the maximum number of satellites. This also needs to be checked before testing.

The logger software can then calculate distance travelled, direction, acceleration and so on based on position data.

How does GPS work?

GPS is a navigation system based on 29 satellites (minimum of 24 active satellites). The full name of the system is “Navigational Satellite Timing and Ranging – Global Positioning System – NAVSTAR-GPS. In the origin this system has been developed by the US Department of Defence. The system has been launched 1995 officially. All satellites circle on an exact orbit so that receiving signals from 6-10 satellites from every position in the world and a minimum of 4 at the same time is possible. Every GPS satellite sends C/A coded data in L1 frequency band with 1575.42 MHz for civil purposes. Beside position and time also a special satellite code is sent to clearly differentiate from other satellites. The GPS receiver decodes these signals (CDMA). The highly precise military P/Y code is not public.

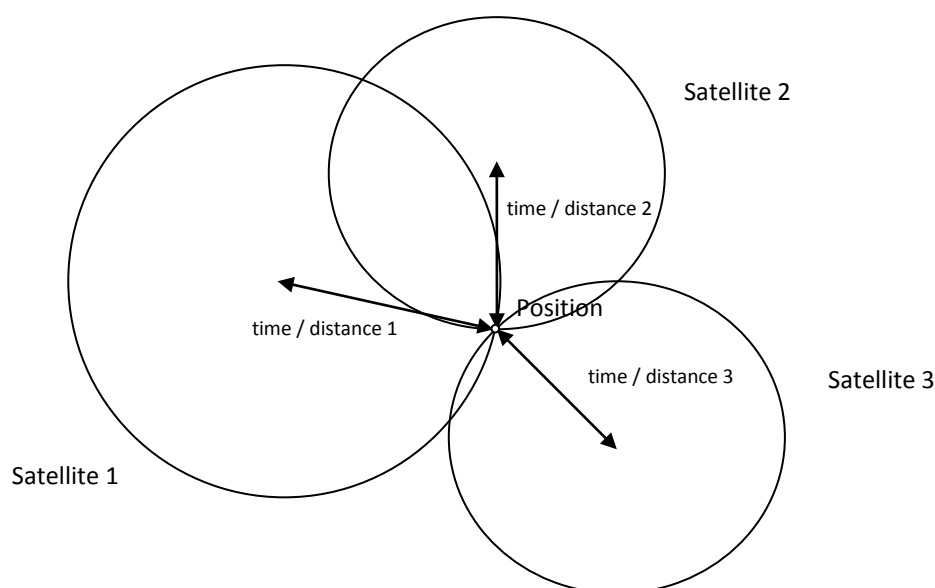

If the GPS sensor receives signals from minimum 3 satellites **latitude** and **longitude** can be precisely analysed from the sensor. 4 satellites allow calculation of **altitude** or height above mean sea level in addition. In aviation “height” is generally used to measure distance between sensor and ground. The more satellites, the better is the stability and the higher the accuracy. Once you power up the GPS sensor first time, it will begin searching for satellites. You need to consider this startup-time in your application. This process can last up to 5 minutes! After the GPS sensor has been initialized it usually lasts less than a minute to get all the signals. Please read the datasheet of your sensor carefully or ask the vendor.

How accurate is GPS?

Position accuracy depends on many factors. The more satellite signals the GPS receiver acquires the better is the signal normally. The position of the satellites and thus the energy level of the signal received is also a driving factor in terms of accuracy. Object that is located between the satellite and the sensor, such as a tall building can cause inaccuracy because of non-receivable or reflective signals. The quality of a standard GPS sensor in general can achieve accuracies of less than 10 m / yard.

Who uses GPS?

GPS is used in many forms - for direct navigation and engineering of vehicles but also for recreational activities like hiking, mountain biking or geo caching and even in monitoring applications. Smart phones and digital cameras are more and more equipped with a GPS receiver focussing on many different service aspects. Meteorologists use it for weather forecasting. Geologists use it to survey or measure tectonic motions for earthquake studies. IMU's are also used in a wide range of different applications. In military and aerospace it is used as main source for guided vehicle navigation. In automotive industry we find kinematic or motion analysis or also validation of vehicles according to standards like ISO4138, ISO7401, ISO7975 or ISO3888-2 (elk test), just to name a few. One of the hot topics at the moment is full autonomous driving and the light version driver assistance systems (ADAS) of cars, trucks or other machines.

QuantumX Data Recorder focusses in motion analysis and load data acquisition of vehicles like cars, trucks, busses, motorcycles, ships, trains and machines for material handling, agriculture and construction.

QuantumX is a flexible tool for all kind of measurement, testing and monitoring purposes acquiring analog and digital data in addition to bus signals from CAN, CCP or XCP in parallel to motion picture (video) and GPS or IMU data.

What is an Inertial Measurement Unit and who uses it?

One major trend in the market in certain application is the need for higher precision. Because of this market demand more and more companies add extra sensors, electronics and software into the unit in addition to GPS/GNS receivers. The overall system forms then a new class of “intelligent sensor” named **Inertial Measurement Unit (IMU)**.

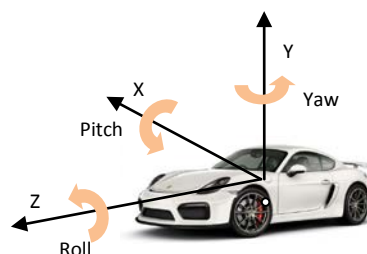

IMUs are typically used in navigation, stabilization, guidance and control for aerospace, defence, geodetic, industrial and automotive and commercial vehicle applications and measures the overall body position and movement in direction, speed and angular rates (pitch, slip, yaw), using a combination of satellite based sensors, accelerometers and gyroscopes (gyro). All information is calculated to each other allowing the IMU to deliver high precision data at an overall higher rate. IMUs are typically used to manoeuvre

Connecting a GPS sensor to QuantumX

Typical data rates of GPS receivers are between 1...10 Hz. As a rule of thumb we can say the higher the performance, speed and accuracy the more interfaces are available and the higher the price. Data is normally transmitted according to the international standard NMEA 0183.

QuantumX Data Recorder CX22B supports the following three types of digital interfaces:

- **USB 2.0 or 3.0**
- **RS232 / DSub-9**
- **CAN bus:** via MX840B or MX471B

RS232 based GPS Sensors

The following GPS-Sensors have been tested together with QuantumX:

- GARMIN GPS 18-5 Hz
- GARMIN GPS 19x HVS
- GARMIN GPS 35 traccpak
- Racelogic VBSS 5/10/20/100 Hz



These types of GPS sensors come with an integrated antenna and an update rate between 1 and 5 Hz and low power consumption. Most receivers can track up to 12 satellites. This type of sensor is mostly used for “just” position tracking of less agile vehicles. An extra power cable needs to be soldered as the RS232 from CX22B does not supply any power.

HINT: HBM offers such a sensor in the SOMAT product range which comes along with a M8 male connector. Material number: 1-EGPS-5HZ-2. You can cut the connector and wire it to a DSub-9.

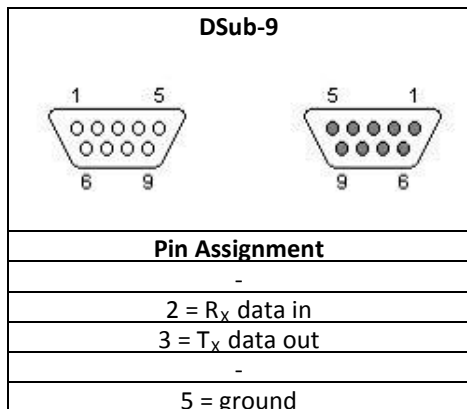

GPS 18 LVC & GPS 18-5Hz PINOUT

GPS 18 Pin #	Color	Signal Name	Wire Gauge
1	Yellow	Measurement Pulse Output	28
2	Red	Vin	26
3	Black	Ground	28
4	White	Transmit Data	28
5	Black	Ground	26
6	Green	Receive Data	28

Table 1: GPS 18 LVC & GPS 18-5Hz Wire Pinout

GPS 18 LVC & GPS 18-5Hz WIRING DIAGRAMS

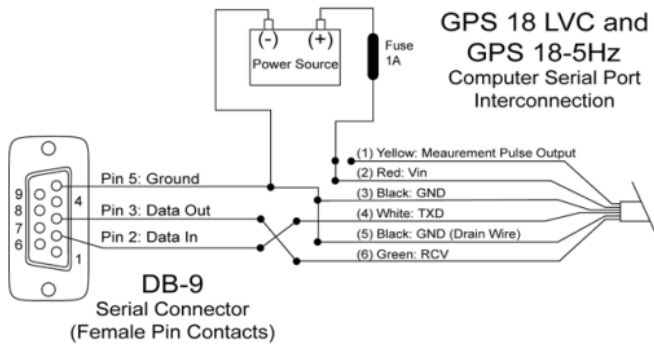

USB based GPS sensor

The following USB based GPS sensor can be recommended to work with the QuantumX Data Recorder.

- NAVILOCK NL-602U GPS, USB based



This type of sensor is easy to connect. A special USB driver maps everything to a COM port like above with RS232. The protocol is also NMEA.

- Install the software and device driver on the Data Recorder CX22B-W.

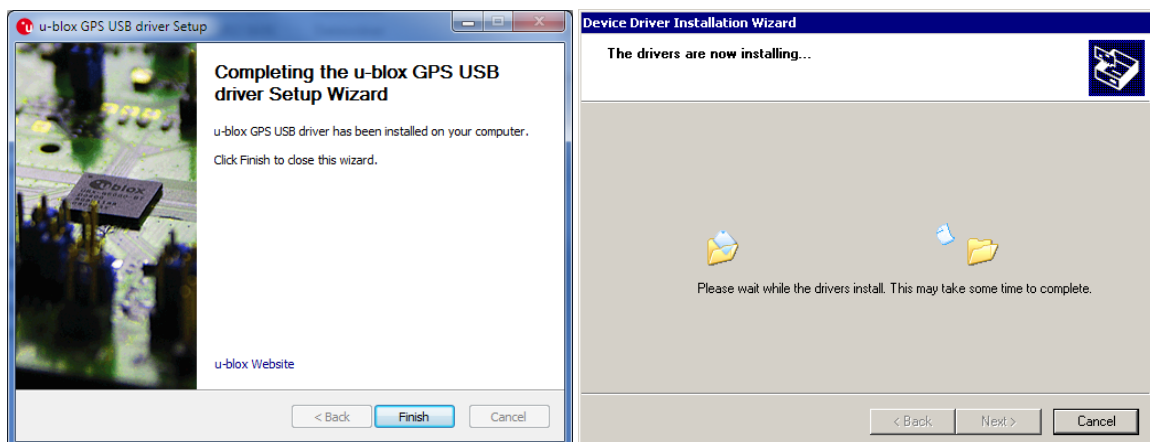

- Now start the device manager and you will find the GPS sensor mapped to a dedicated COM port.

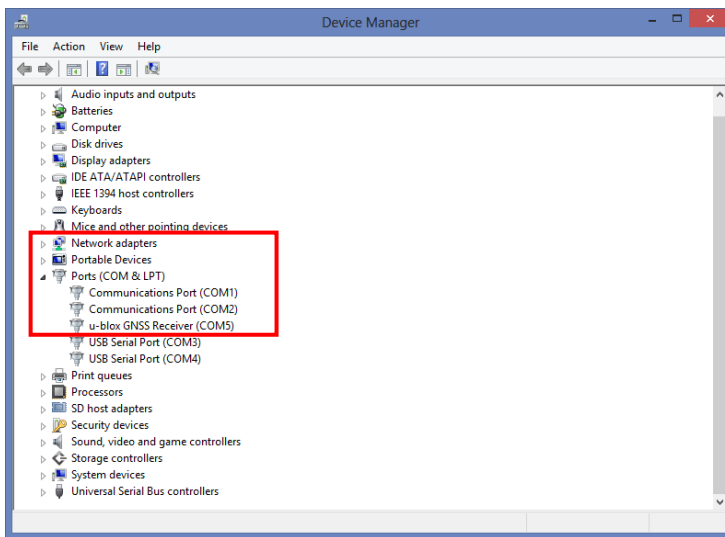

- In case you installed the driver by yourself on the Data Recorder please “save and restart” this configuration making it permanently available.

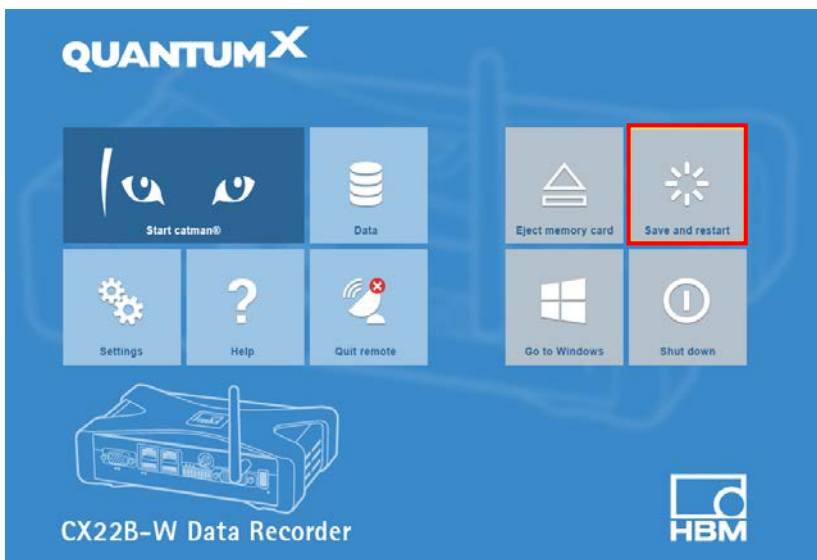

Work with GPS connected to the Data Recorder

1. Start catman and open “select device type”



2. Open “Options” and go to the tab "Additional devices" and add a “new device”

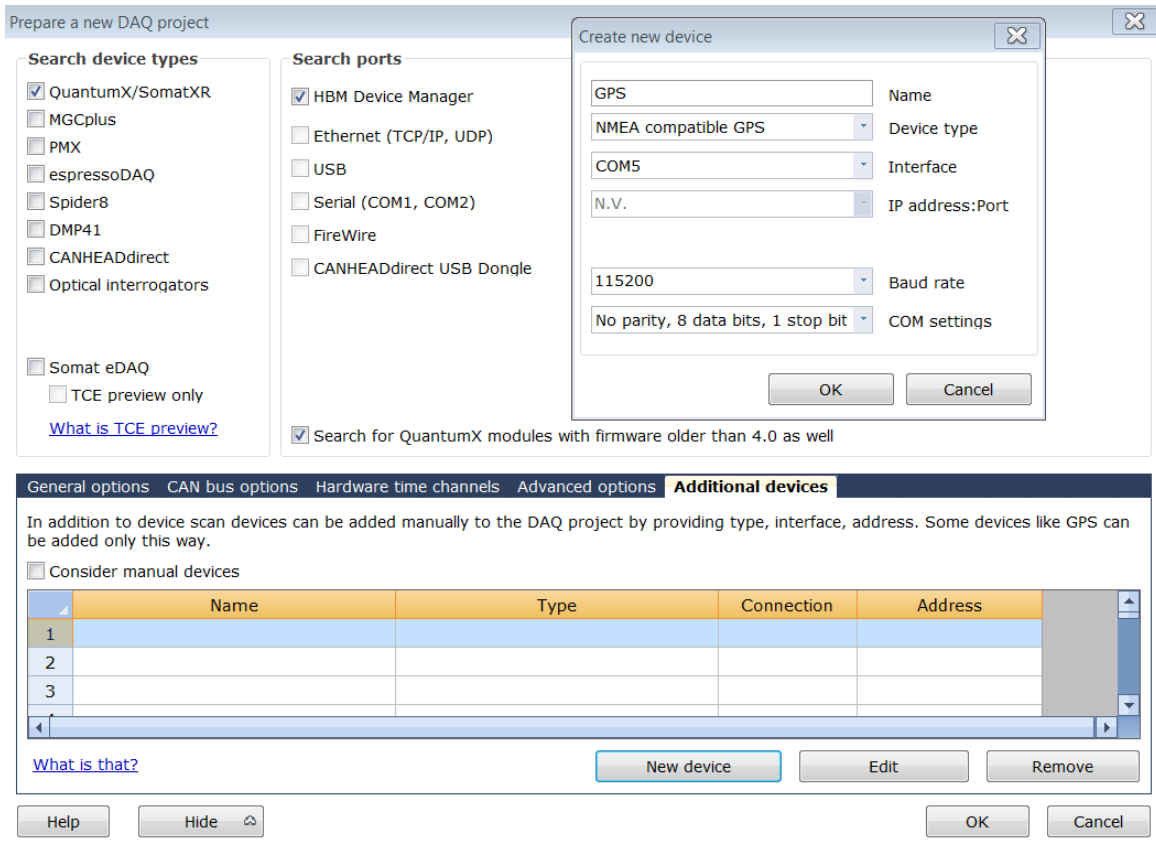



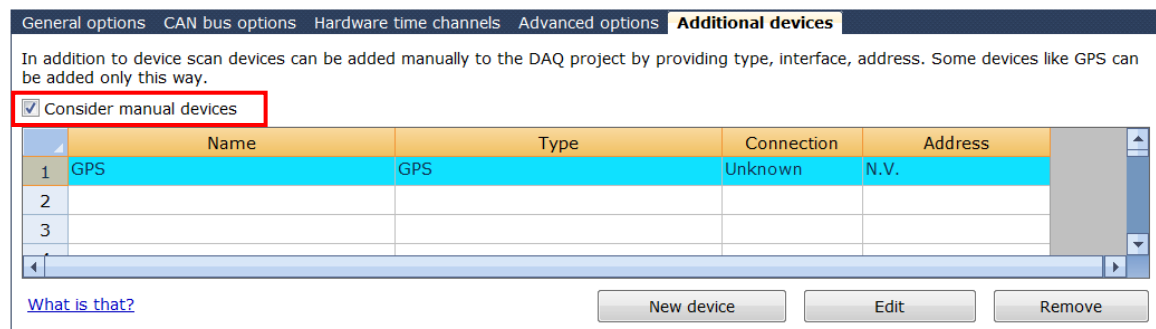

































































3. Configure the port according to your settings. Here COM5, 115000 baud rate.
4. Highlight “Consider manual devices" and finish configuration with OK



From now on your GPS sensor is connected automatically to all projects.

5. Check the sensor data in the channel list. You will find longitude, latitude, altitude, speed and time coming from the GPS sensor

	Channel name	Reading	Sample rate/Filter	Sensor/Function	Zero value
MX840A Universal					
	load cell	 -0.00342 kN	▶▶ 1200 Hz / BE 100 Hz (Auto)	 C18 100kN	-8.117 kN
	microphone	 -0.00040 V	▶▶ 1200 Hz / BE 100 Hz (Auto)	 DC Voltage	0.00000 V
	voltage input	 -0.00090 V	▶▶ 1200 Hz / BE 100 Hz (Auto)	 DC Voltage	0.00000 V
	MX840A Universal_CH 4	 526.1 V	▶▶ 1200 Hz / BE 100 Hz (Auto)	 DC Voltage	0.00000 V
	speed sensor	 0.00000 U/min	▶▶ 1200 Hz / BE 100 Hz (Auto)	 Pulse count: 2-phase, 4-fo	0.00000 U/min
	MX840A Universal_CH 6	 No signal	▶▶ 1200 Hz / BE 100 Hz (Auto)	 Thermocouple Type T	0.00000 °C
	MX840A Universal_CH 7	 No signal	▶▶ 1200 Hz / BE 100 Hz (Auto)	 DC Voltage	0.00000 V
	MX840A Universal_CH 8	 No signal	▶▶ 1200 Hz / BE 100 Hz (Auto)	 DC Voltage	0.00000 V
Navilock_GPS_COM5					
	Navilock_GPS_COM5_Latitude	 49.89 () °	▶ 10 Hz / NA	 LATITUDE	0.00000 °
	Navilock_GPS_COM5_Longitude	 8.643 () °	▶ 10 Hz / NA	 LONGITUDE	0.00000 °
	Navilock_GPS_COM5_Altitude	 121.0 () m	▶ 10 Hz / NA	 ALTITUDE_M	0.00000 m
	Navilock_GPS_COM5_Speed	 0.9760 () km/h	▶ 10 Hz / NA	 SPEED_OVER_GROUND	0.00000 km/h
	Navilock_GPS_COM5_Time	 55525 (1/1/1970 3:2	▶ 10 Hz / NA	 TIME	0.00000 s
	Navilock_GPS_COM5_Date	 42427 (2/26/2016) -->	▶ 10 Hz / NA	 DATE	0.00000 ----
	Navilock_GPS_COM5_SatStatus	 0.00000 () ----	▶ 10 Hz / NA	 SATELLITE_STATUS	0.00000 ----
	Navilock_GPS_COM5_Gyro_Pitch	 No signal	▶ 10 Hz / NA	 GYRO_PITCH	0.00000 °
	Navilock_GPS_COM5_Gyro_Roll	 No signal	▶ 10 Hz / NA	 GYRO_ROLL	0.00000 °
	Navilock_GPS_COM5_Gyro_Yaw	 No signal	▶ 10 Hz / NA	 GYRO_YAW	0.00000 °
	Navilock_GPS_COM5_MagHeading	 0.00000 () °	▶ 10 Hz / NA	 MAGNETIC_HEADING	0.00000 °
	Navilock_GPS_COM5_TrueHeading	 0.00000 () °	▶ 10 Hz / NA	 TRUE_HEADING	0.00000 °
	Navilock_GPS_COM5_TurnRate	 No signal	▶ 10 Hz / NA	 TURN_RATE	0.00000 °/s
	Navilock_GPS_COM5_WindDirection	 No signal	▶ 10 Hz / NA	 WIND_DIRECTION	0.00000 °
	Navilock_GPS_COM5_WindSpeed	 No signal	▶ 10 Hz / NA	 WIND_SPEED	0.00000 m/s

IMPORTANT: At least one QuantumX DAQ module is necessary in parallel.

Connecting an IMU to the QuantumX Data Recorder

Many IMUs come along with a digital **CAN bus** interface which can be integrated in QuantumX in an easy way. We recommend using a private bus between IMU and QuantumX. Bus termination might be necessary on both sides. MX471B offers an internal 120 Ohm termination resistor which can be activated via software terminating the bus. When using a short cable between sensor and QuantumX this single terminator might be OK. For MX840B the termination resistor needs to be soldered into the SubHD plug.

Potential suppliers:

- iMAR, offers IMU – inertial measurement units
 - o Output: CAN with maximum 100 Hz
 - o <http://www.imar-navigation.de>
- NovAtel, offers FlexPak
 - o CAN with maximum 100 Hz
 - o <http://www.novatel.com/products/gnss-receivers/enclosures/flexpak6/>
- Racelogic, offers VBOX Speed Sensor
 - o Output: CAN
 - o <http://www.racelogic.co.uk/>
- Race Technology, offers SPEEDBOX
 - o Output: CAN
 - o <http://www.race-technology.com/gb/industrial/products/speedbox>

1. Connect the IMU to a private CAN bus node on MX471B: port 1, 2, 3 or 4 or on port 1 of MX840B
Hint: take in mind that you might have to terminate the CAN bus on the QuantumX side (MX840B in the plug, MX471B via software command)
2. Go to sensor database: import the CAN configuration file (dbc) from the vendor to the sensor database
3. Go to channel overview: drag and drop the relevant signals to the CAN port and configure the CAN node.
Example: 500 kBit, termination ON with MX471B
4. Visualize the signals with numerical indicators

HINT: At least one QuantumX module is necessary in combination with GPS signals.

Map based Visualization and Analysis

The Data Recorder software catman can be extended by an add-on package named EasyRoadLoad.

This package allows visualization of GPS data in *google maps*. Initially internet access is necessary to get the maps. After this you can store your track as picture locally.

To activate this functionality a valid license key is necessary.

Additional modules (additional license required)

<input checked="" type="checkbox"/> EasyRoadload (autonomous data recording with MGCplus, support for Kistler RoaDyn wheel force transducers, video, geo. maps)
<input type="checkbox"/> EasyOptics (measurements with optical sensors)

- Go to Visualization tab and select the map out of the objects.

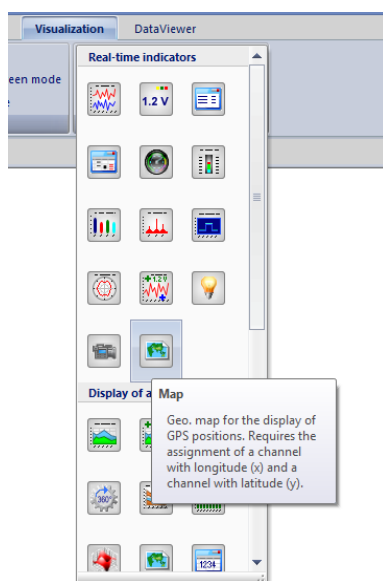

- Assign the inputs for longitude and latitude to the map. You can visualize altitude as digital indicator:

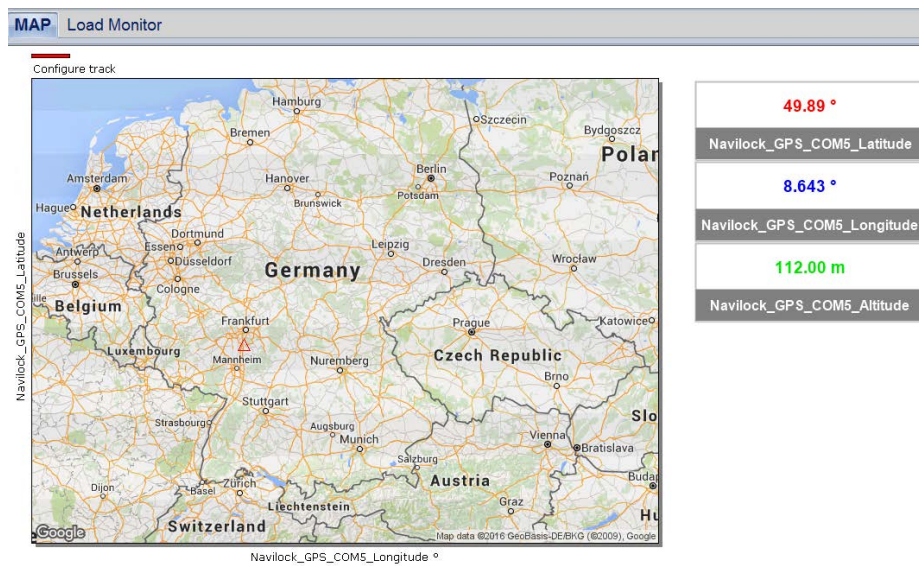

- Configure how your plot shall look like in the map: **current position** or **track**:

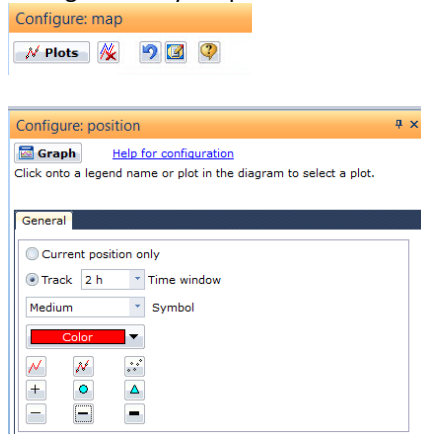

- Configure the map type (street map, satellite, terrain or hybrid)

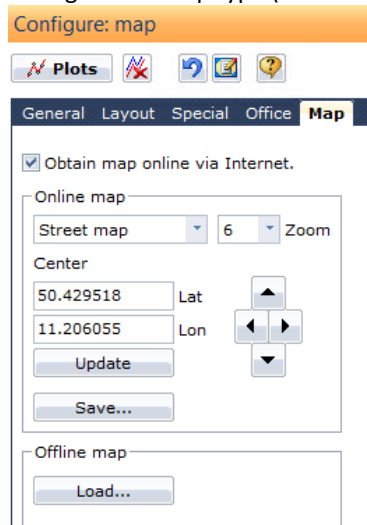

- In most of the cases you won't have internet access. In this case enter the rough coordinates of your test track and zoom into the map for positioning.
Example: Racetrack Nuerburging in Germany with



- Save the map

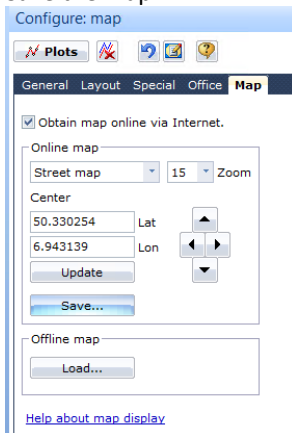

And load it when in the field for testing.

Map based post process analysis in catmanAP

Back in office download all data from the Data Recorder. Now you can nicely analyse it with catmanAP.

You can visualize a reference signal in a coloured style according to its value in the map.

Example: Engine speed from 0 (blue).... 8600 rpm (red) mapped to a certain position at that time.

Others are vehicle speed, gear, brakes or analog inputs like strain, acceleration, temperature, direct torque, pressure, battery voltage, etc.

Example shows the Hockenheim Ring in Germany:

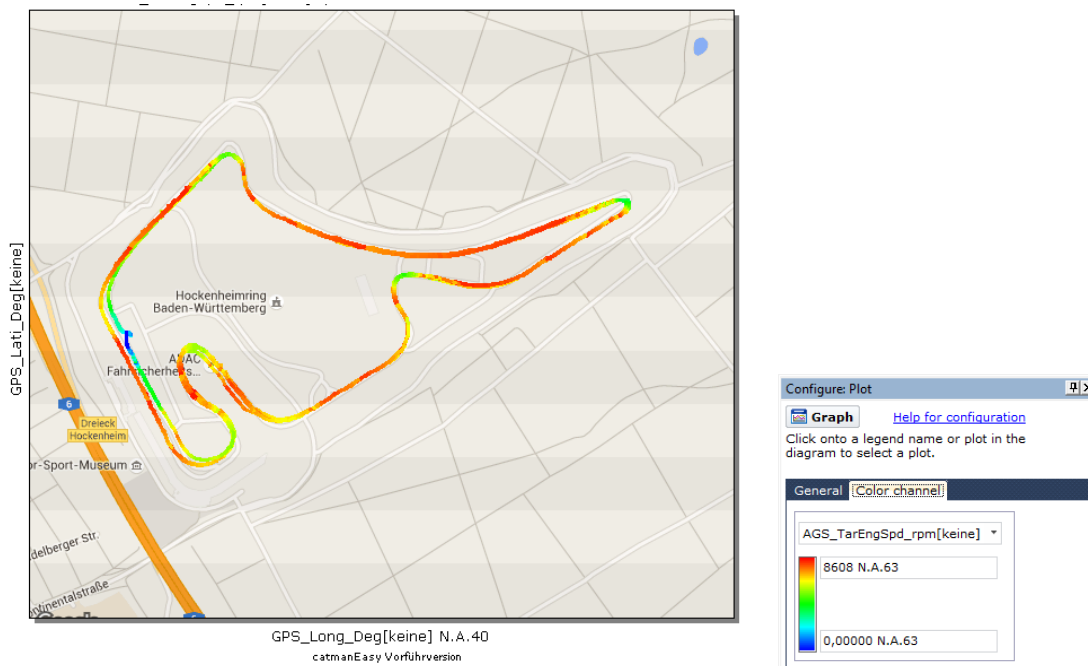

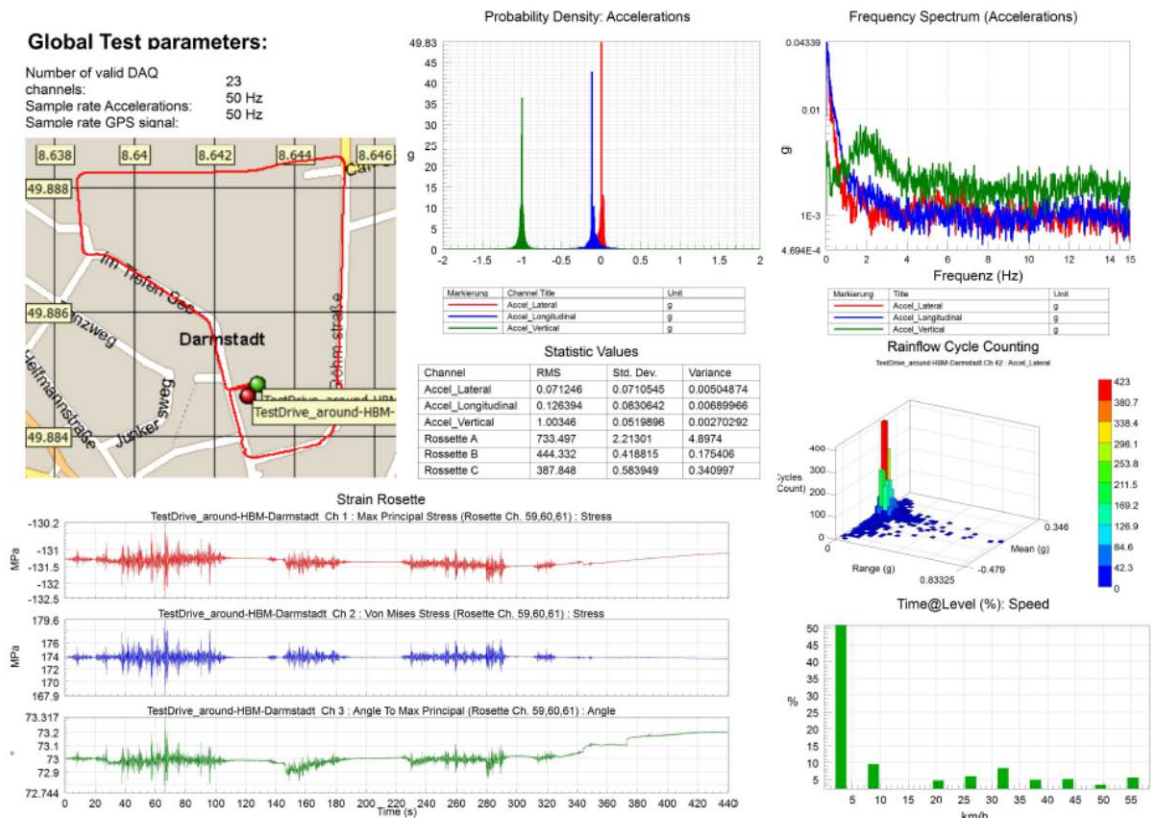

Picture: GlyphWorks – automatically generated vehicle test report visualize all aspects of your test drive: meta data, signal data, position, etc.

-- end

Legal Disclaimer: TECH NOTES are designed to provide a quick overview. TECH NOTES are continuously improved and so change frequently. HBM assumes no liability for the correctness and/or completeness of the descriptions. We reserve the right to make changes to the features and/or the descriptions at any time without prior notice.