

Measurement amplifier
for panel mounting

MVD2510



Contents	Page
1 Safety instructions	5
2 Scope of supply	11
3 Introduction	11
3.1 General	11
3.2 Block diagram	12
4 Mounting	12
4.1 Read before mounting, factory setups	12
4.2 Change factory setups	13
4.2.1 Adjust analogue output signal	14
4.2.2 Fuse replacement	14
4.3 Insert unit plug-in strip	15
4.4 Install amplifier on control cabinet	16
5 Electrical connection	17
5.1 Connect voltage supply	17
5.2 Connect transducers	19
5.3 Analogue output, Control inputs/outputs	21
6 Adjustments and operation	22
6.1 Start-up and factory setups	22
6.2 Device operation and survey of keyboard functions	24
6.3 Functions in Measure mode	25
6.3.1 Adjust limit-value levels in the Measure mode	26
6.4 Programming mode	28
6.4.1 Change from the "Measure" to the "Programming" mode ..	29
6.4.2 Programming	30
Operation in the Programming mode	30
6.4.3 Change from the "Programming" to the "Measure" mode ..	31
6.5 Information on groups and parameters	32
6.5.1 Dialog (dIAL)	32

6.5.2	Load/Save in parameter set (PArA)	33
6.5.3	Calibration (CAL)	34
6.5.4	Limit values (Li1, Li2)	35
6.5.5	Inputs and outputs (I_O)	37
6.5.6	Additional function (InFO)	38
7	Example	39
8	Displays and ex-works settings	51
9	Error messages	52
10	Keyword index	53

1 Safety instructions

Appropriate use

The MVD2510 with the connected transducers may be used for measurement and directly related control and regulation tasks, only. Any other use is not appropriate. To ensure safe operation, the transducer may only be used according to the specifications given in this manual. It is also essential to comply with the legal and safety requirements for the application concerned during use. The same applies to the use of accessories.

Each time, before starting up the equipment, you must first run a project planning and risk analysis that takes into account all the safety aspects of automation technology. This particularly concerns personal and machine protection.

Additional safety precautions must be taken in plants where malfunctions could cause major damage, loss of data or even personal injury. In the event of a fault, these precautions establish safe operating conditions.

This can be done, for example, by mechanical interlocking, error signaling, limit value switches, etc.



WARNING

Due to the fact that the device has not been equipped with a proper mains switch, the supply cable must not be connected directly to the mains. VDE guidelines require that the device can be disconnected from the mains via a switching device (double-break disconnecter). It is essential that the disconnecter is labeled accordingly and easy to access and operate by the user.

Before connecting the device, make sure that the mains voltage and current type specified on the name plate correspond to the mains voltage and current type at the site of installation and that the current circuit used is sufficiently safe.

Devices designed for panel mounting may only be operated in an EMC-tested control cabinet. (see page LEERER MERKER).

The device complies with the safety requirements of DIN EN 61010-part1 (VDE 0411-part1); protection class I.

General dangers in the case of non-observance of the safety instructions

The MVD2510 complies with the state of the art and is operationally reliable. If the device is used and operated inappropriately by untrained personnel, residual dangers might develop.

Any person charged with device installation, operation, maintenance or repair must in any case have read and understood the operating manual and the safety instructions, in particular.

Conditions on site

- Protect the device from direct contact with water.
- Protect the PMX system from moisture and humidity or weather conditions such as rain, snow, etc. The degree of protection per EN 60529 standard is IP 40 (device as a whole); IP51 (front, membrane keypad)
- Do not expose the device to direct sunlight.
- Please observe the permissible maximum ambient temperatures stated in the specifications.
- The permissible relative humidity at 31 °C is 95 % (non condensing); linear reduction to 50 % at 40 °C.
- It is safe to operate the MVD2510 system up to a height of 2000 m.
- Mounting in an EMC-tested control cabinet with line filter (see page LEERER MERKER).

Maintenance and cleaning

MVD2510 devices are maintenance-free. Please note the following points when cleaning the housing:

- Withdraw the mains plug from the socket before carrying out any cleaning.
- Clean the housing with a soft, slightly damp (not wet!) cloth. You should **on no account** use solvent, since it may damage the labelling on the front panel and the indicator box.
- When cleaning, ensure that no liquid gets into the device or connections.

Residual dangers

The MVD2510's scope of performance and supply covers part of the measuring-technology, only. The plant designer/constructor/operator must in addition design, realise and take responsibility for the measuring-system's safety such that potential residual dangers are minimized. The respective regulations must in any case be observed. Residual dangers regarding the measuringsystem must be specified explicitly.

Product liability

In the following cases, the protection provided for the device may be adversely affected. Liability for device functionality then passes to the operator:

- The device is not used in accordance with the operating manual.
- The device is used outside the field of application described in this Chapter.
- The operator makes unauthorized changes to the device.

Warning signs and danger symbols

Important instructions for your safety are specifically identified. It is essential to follow these instructions in order to prevent accidents and damage to property.

Safety instructions are structured as follows:





Type of danger

Consequences of non-compliance

Averting the danger

- **Warning sign:** draws your attention to the danger
- **Signal word:** indicates the severity of the danger (see table below)
- **Type of danger:** mentions the type or source of the danger
- **Consequences:** describes the consequences of non-compliance
- **Defense:** indicates how the danger can be avoided/bypassed

Danger class according to ANSI

Warning sign, signal word	Significance
 WARNING	This marking warns of a <i>potentially</i> dangerous situation in which failure to comply with safety requirements <i>can result in death or serious physical injury</i> .
 CAUTION	This marking warns of a <i>potentially</i> dangerous situation in which failure to comply with safety requirements <i>can result in slight or moderate physical injury</i> .
NOTE	This marking draws your attention to a situation in which failure to comply with safety requirements <i>could lead to damage to property</i> .



On the module

Meaning: **Take details in the operating manual into account**



On the module

Meaning: **Disconnect mains supply before opening**



On the module

Meaning: **CE mark**

The CE mark is used by the manufacturer to declare that the product complies with the requirements of the relevant EC directives (the Declaration of Conformity can be found at <http://www.hbm.com/HBMdoc>).

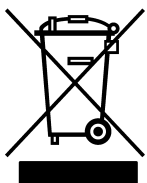

On the module

Meaning : **Statutory waste disposal mark**

The electrical and electronic devices that bear this symbol are subject to the European Waste Electrical and Electronic Equipment Directive 2002/96/EC.

The symbol indicates that the device must not be disposed of as household garbage.

In accordance with national and local environmental protection and material recovery and recycling regulations, old modules that can no longer be used must be disposed of separately and not with normal household garbage.

If you need more information about waste disposal, please contact your local authorities or the dealer from whom you purchased the product.

As waste disposal regulations within the EU may differ from country to country, we ask that you contact your supplier as necessary.

Working safely

Note

Due to the fact that the device has not been equipped with a proper mains switch, the supply cable must not be connected directly to the mains. VDE guidelines require that the device can be disconnected from the mains via a switching device (double-break disconnecter). It is essential that the disconnecter is labeled accordingly and easy to access and operate by the user.

The supply connection, as well as the signal and sense leads, must be installed in such a way that electromagnetic interference does not adversely affect device functionality (HBM recommendation: "Greenline shielding design", downloadable from the Internet at <http://www.hbm.com/Greenline>).

Automation equipment and devices must be covered over in such a way that adequate protection or locking against unintentional actuation is provided (such as access checks, password protection, etc.).

When devices are working in a network, these networks must be designed in such a way that malfunctions in individual nodes can be detected and shut down.

Safety precautions must be taken both in terms of hardware and software, so that a line break or other interruptions to signal transmission, such as via the bus interfaces, do not cause undefined states or loss of data in the automation device.

Reconstruction and modifications

HBM's express consent is required for modifications regarding the MVD2510's construction and safety. HBM does not take responsibility for damage resulting from unauthorized modifications.

In particular, repair and soldering works on the boards are prohibited. If complete componentry is replaced use original HBM components, only.

The product is delivered from the factory with a fixed hardware and software configuration. Changes can only be made within the possibilities documented in the manuals.

Qualified personnel

Qualified personnel means persons entrusted with siting, mounting, starting up and operating the product, who possess the appropriate qualifications for their function (qualified electrician, or by someone with electrical training under the supervision of a qualified electrician).

This device is only to be installed and used by qualified personnel strictly in accordance with the specifications and with the safety rules and regulations which follow.

This includes people who meet at least one of the three following requirements:

- Knowledge of the safety concepts of automation technology is a requirement and as project personnel, you must be familiar with these concepts.
- As automation plant operating personnel, you have been instructed how to handle the machinery and are familiar with the operation of the equipment and technologies described in this documentation.
- As commissioning engineers or service engineers, you have successfully completed the training to qualify you to repair the automation systems. You are also authorized to activate, to ground and label circuits and equipment in accordance with safety engineering standards.

It is also essential to comply with the legal and safety requirements for the application concerned during use. The same applies to the use of accessories.



Important

The safety instructions are also included in paper format with the product ("Documentation and Safety instructions PMX" A3260-2.0).

2 Scope of supply

The scope of supply includes:

- MVD2510 device with two threaded fastening screws
- MVD2510 operating manual incl. a questionnaire
- 15-pin D-plug for transducer connection
- Unit plug-in strip
- 1 terminal-strip plug (9 pins) for connection of the control inputs and outputs, 1 terminal-strip plug (3 pins) for mains connection

3 Introduction

3.1 General

The MVD2510 amplifier for panel mounting (to DIN 43 700) enables measurements from strain-gauge transducers used for industrial weighing **(not legal for trade)** applications to be acquired and processed.

Main characteristics:

- Transducers that may be connected: S/G full bridges
- 4 1/2-digit LED display ($\pm \square 9999$ Digits) and various special characters
- Operation via foil-type keyboard; single keys can be locked
- 2 limit-value switches
- Control inputs and outputs (electrically isolated by optocouplers)

3.2 Block diagram

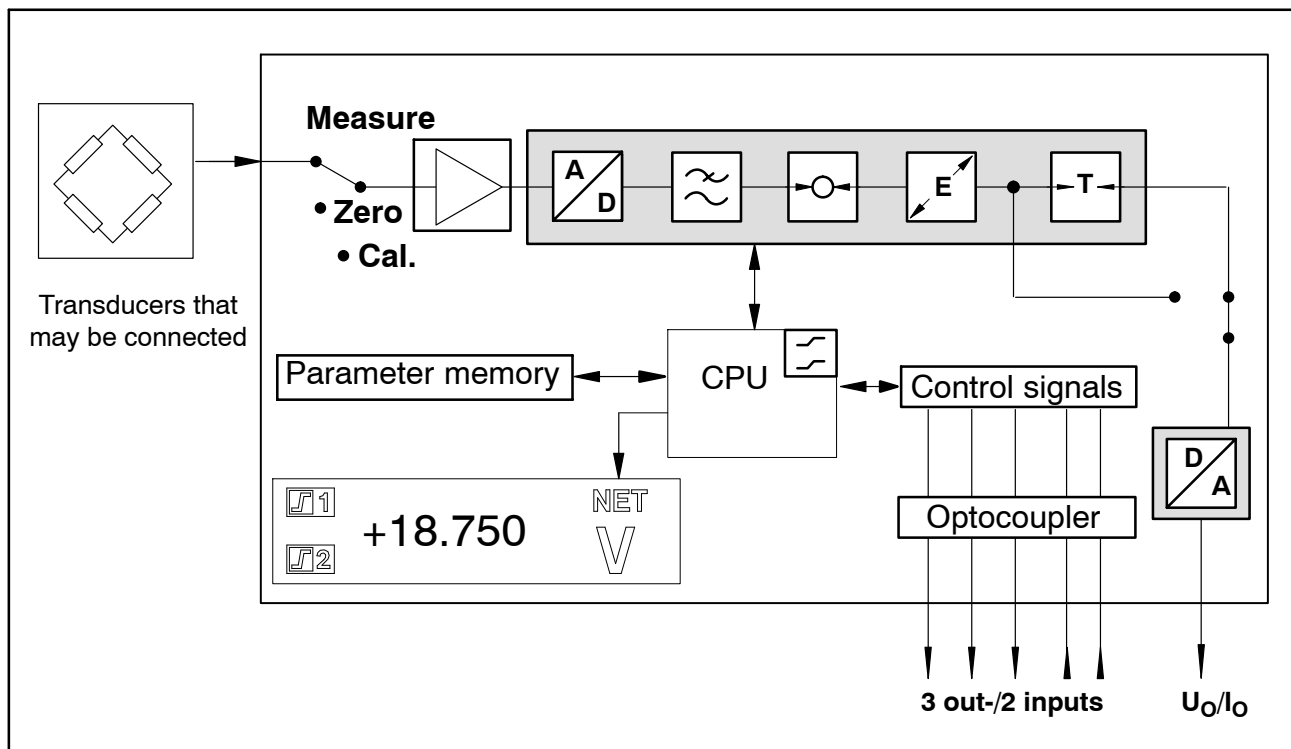

Fig. 3.1 MVD 2510 block diagram

4 Mounting

4.1 Read before mounting, factory setups

Before installing the MVD2510 panel amplifier, check the parameters that have been adjusted at the factory, because the elements required for the selection of the analogue output signal (current/voltage output) are located on the board.



Important

The device must be mounted in an EMC-tested control cabinet with line filter (see page LEERER MERKER).

Factory setup:

- Mains voltage: 230 V / 50...60 Hz or 115 V / 50..60 Hz according to your order
- Analogue output: Output voltage ± 10 V

4.2 Change factory setups

Select analogue output signal

To change the factory setup proceed as follows:

- 1 Slacken the four screws on the housing rear.
- 2 Carefully pull off to the back the housing rear and the board until the jumper arrangement is accessible. For this purpose, introduce a screw driver between connection plate and housing to lift off the device back panel.
- 3 Use the plug bridges to change the desired setups according to Fig. 4.2.
- 4 Insert housing rear and fasten with screws.

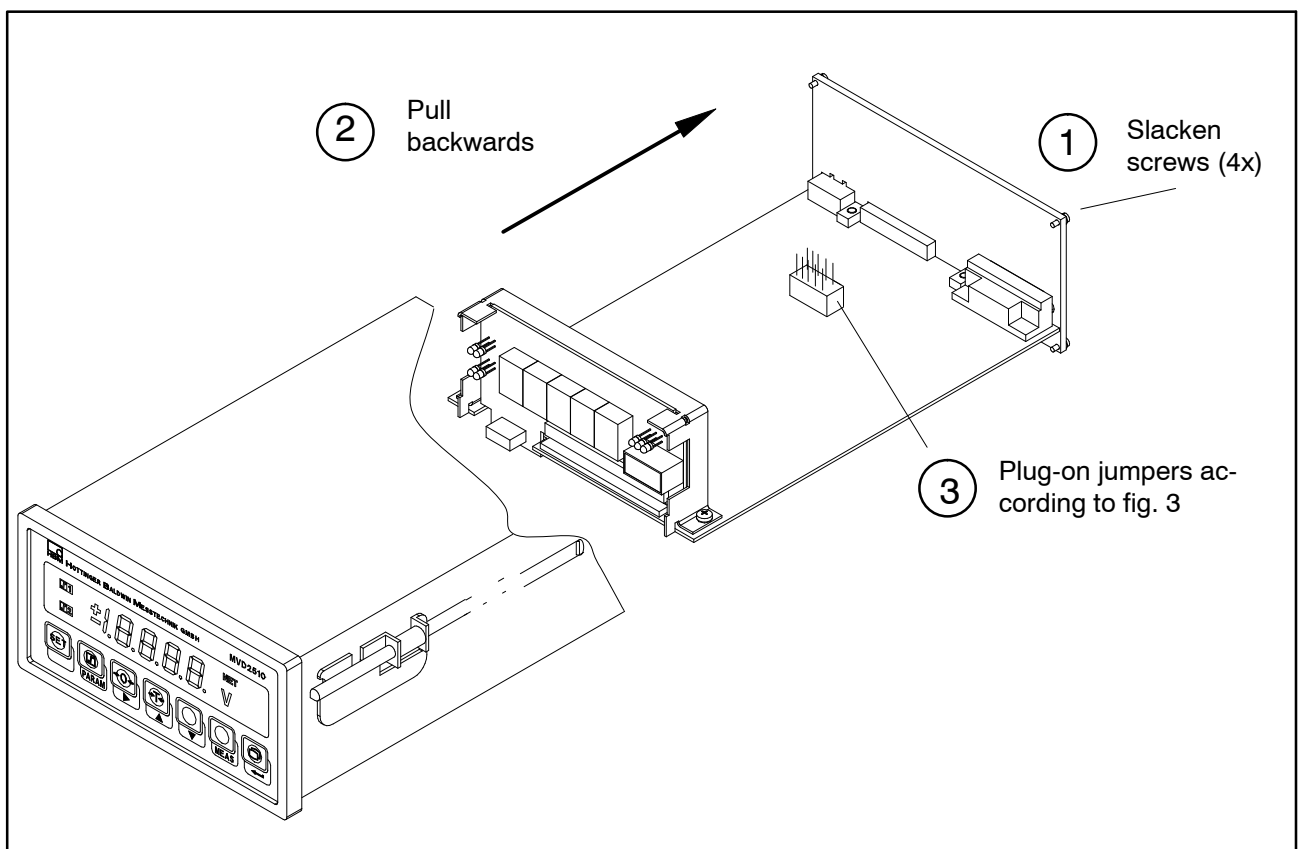

Fig. 4.1: Change factory setup

4.2.1 Adjust analogue output signal

Change the position of jumper ST5 to select the analogue output signal (voltage or current), see Fig. 4.2. Enter the dialog mode to select ± 20 mA or 4...20 mA respectively.

4.2.2 Fuse replacement



WARNING

Disconnect the device from the mains supply before opening the MVD2510.

To replace the fuse you have to take off the device rear as described above. Then, the fuse (230 V/100 mA; 115 V/200 mA) on the board will be accessible (lift off transparent cap).

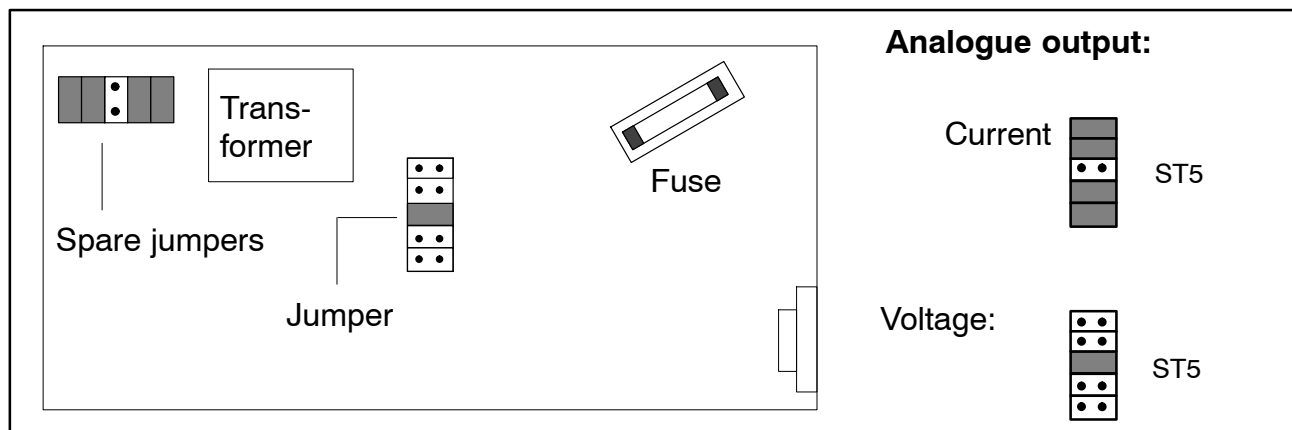
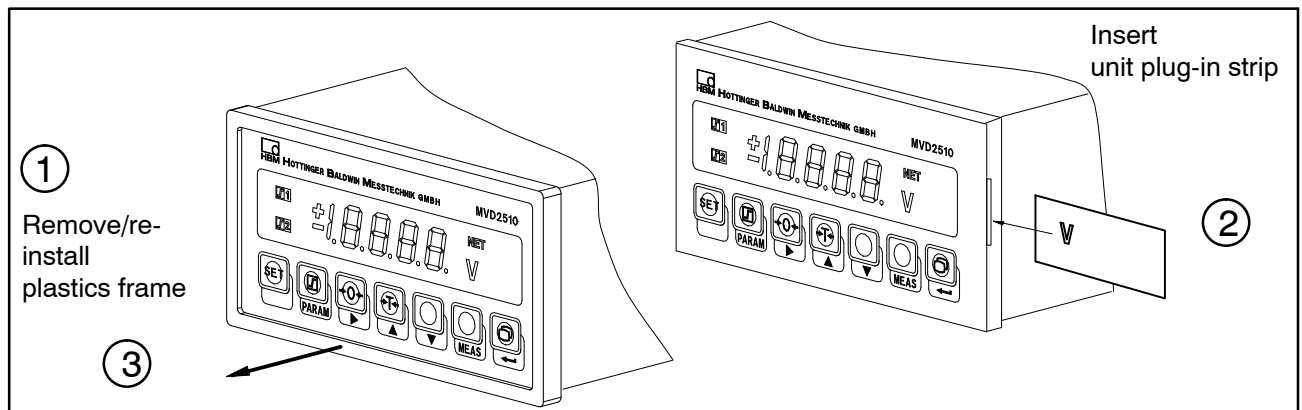

Fig. 4.2: Position of the jumper and fuse on the board

4.3 Insert unit plug-in strip

The unit for display is defined by ready-made plug-in strips that are supplied with the device.

- 1 Remove the display's plastics frame.
- 2 Insert the required strip into the appropriate cutout.
- 3 Re-install the plastics frame on the housing.



4.4 Install amplifier on control cabinet

The MVD2510 has been designed for panel mounting according to DIN43 700.

Install amplifier on panel:

- 1 Turn fastening bow downwards and remove it from housing.
- 2 Insert housing into panel cutout from the front.
- 3 Hook in fastening bow on both sides, turn upwards and screw-fasten with the two threaded rods on the cutout.
- 4 Then connect the supply voltage to the transducer as described in chapter 4.

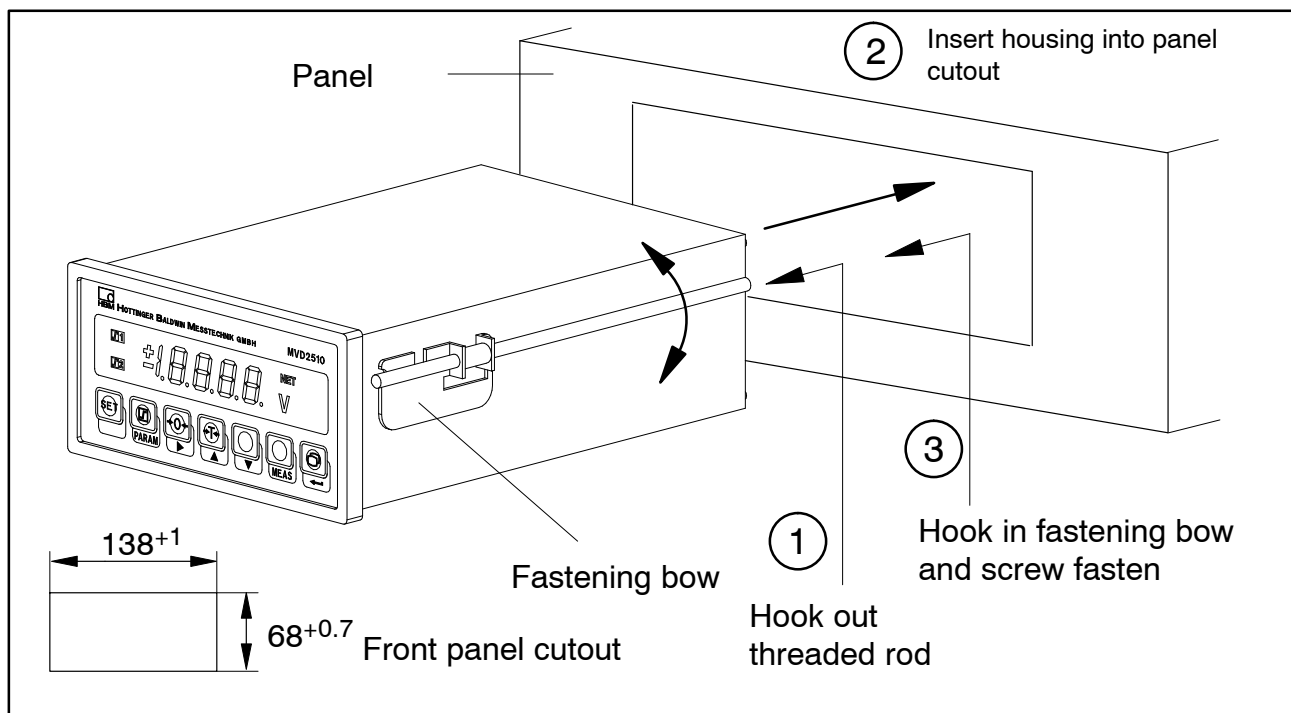

Fig. 4.3 Install housing on panel

5 Electrical connection

5.1 Connect voltage supply

Compare the device's mains voltage (specified on device rear) to the supply voltage. If they are not identical, contact your HBM representative.

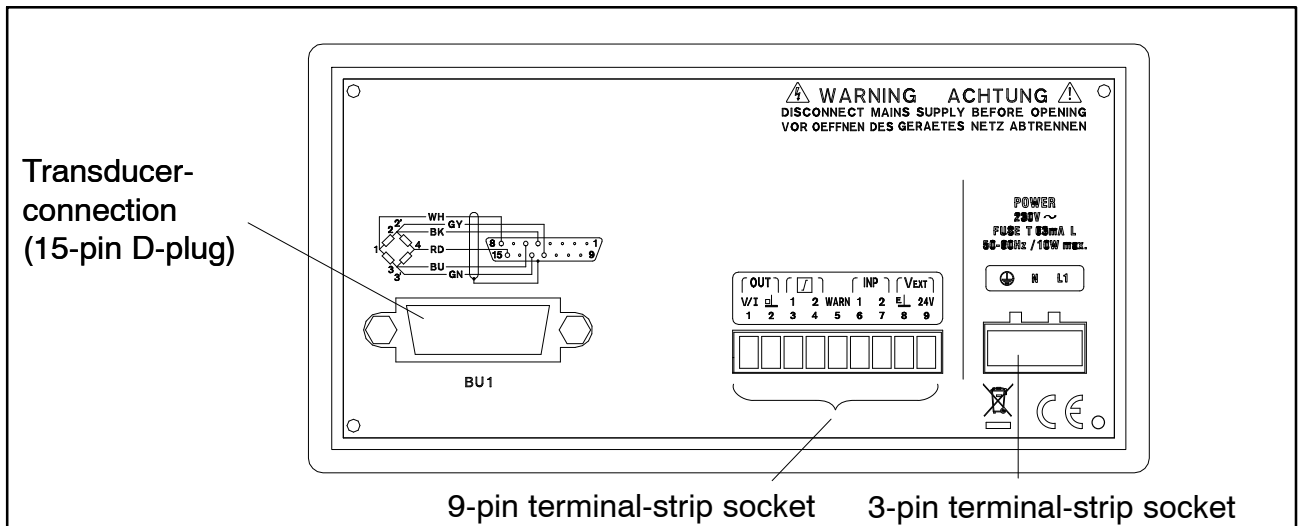

Fig. 5.1: Device rear

WARNING

Due to the fact that the device has not been equipped with a proper mains switch, the connected supply cable may not be connected to mains directly. According to a VDE recommendation the device must be equipped with a switching device that can be disconnected from the mains supply.

Note

Ensure that the device is installed in an EMC-tested control cabinet and connected to a suitable mains filter, e.g. a single-stage filter, 1 ampere with the following structure:

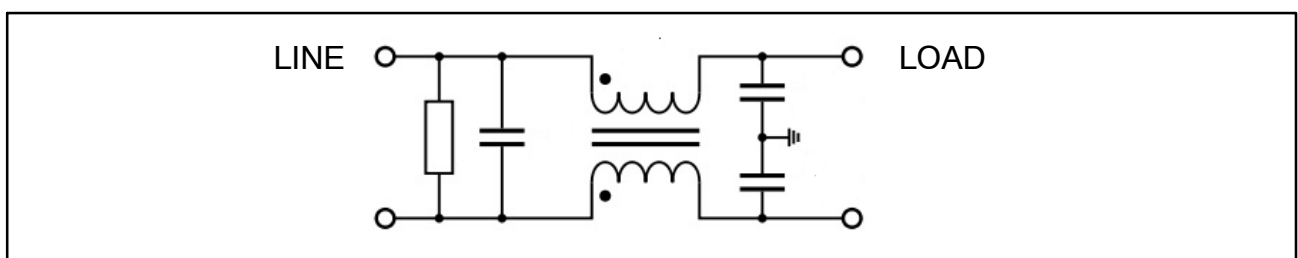

Mounting of the line filter:

- Make sure that the line filter is laid out flat on the inside of the control cabinet and that the connecting cables are led directly to the filter's input connectors.
- The filter is laid out flat on the control cabinet.
- The contact area needs to be clean and blank.

For more information please refer to the mounting instructions provided by the manufacturer of the control cabinet.

Connect mains cable:

- **Connection to the power supply may only be made in the de-energized state !**
- Use end sleeves for the mains cable's core ends or twist them.
- Screw the core ends onto the terminal-strip connector (3 pins)

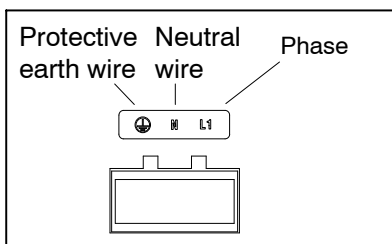
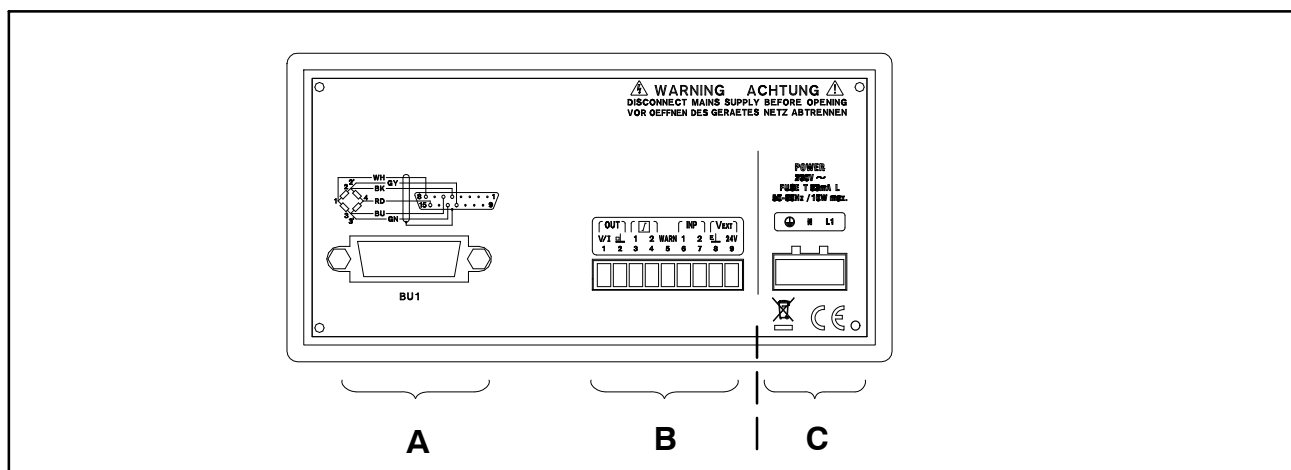

Fig. 5.2: Assignment of terminal strip connector (3-pole)

- Connect terminal-strip connector (3 pins) to mains-connection socket

Note

It is essential that the cables are suitable for the mains voltage. Between the connectors of the nine- and three-pin terminals, appropriate measures need to be taken to prevent disturbance voltages. Ensure separate cable routing between sensor connector (A), signal output (B) and voltage supply (C).



5.2 Connect transducers

The MVD2510 enables S/G full-bridge transducers to be connected via a 15-pin D-plug designated BU1 on the housing rear. See the below figures for the connection diagram.

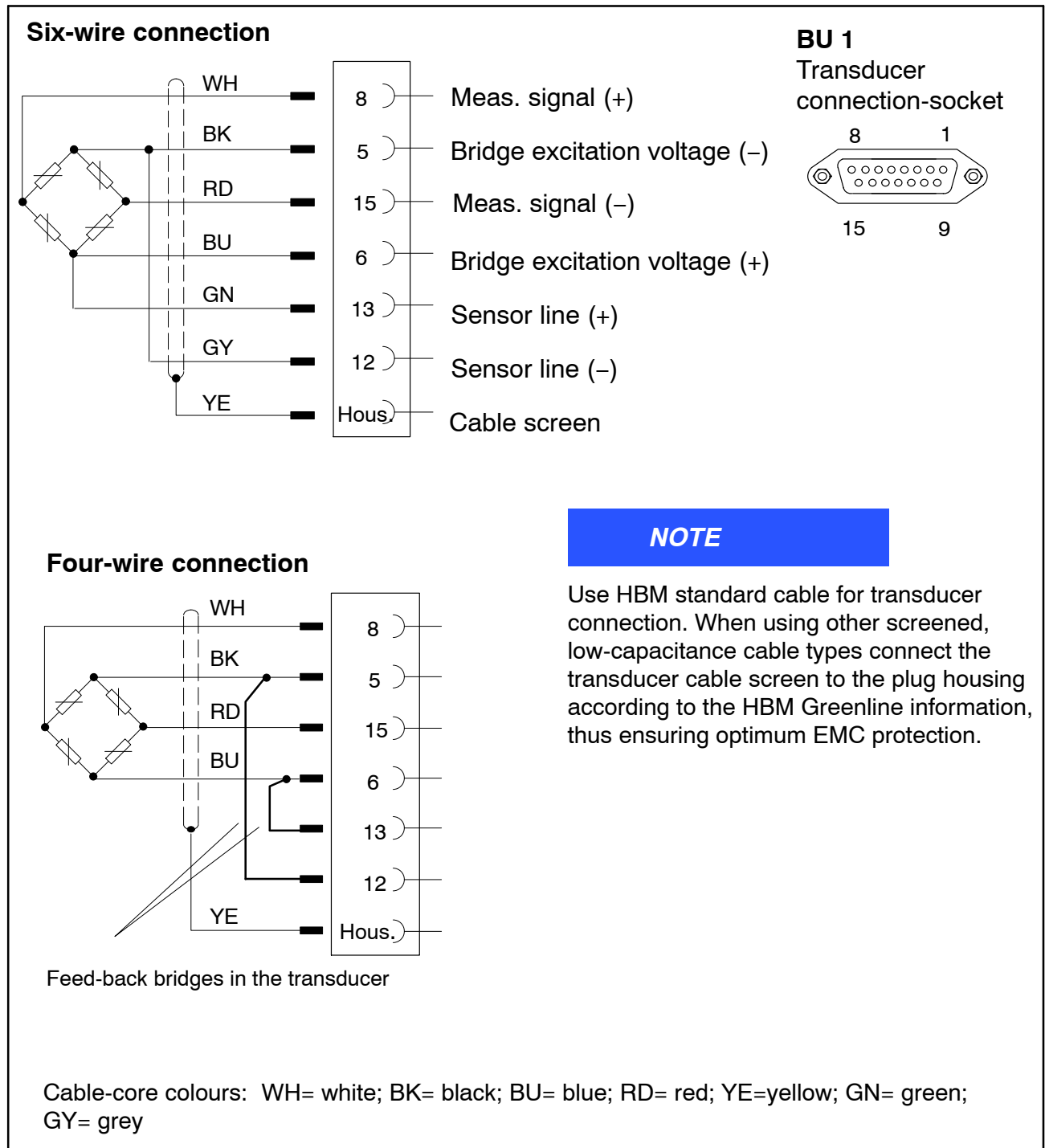

Fig. 5.3 Transducer connection

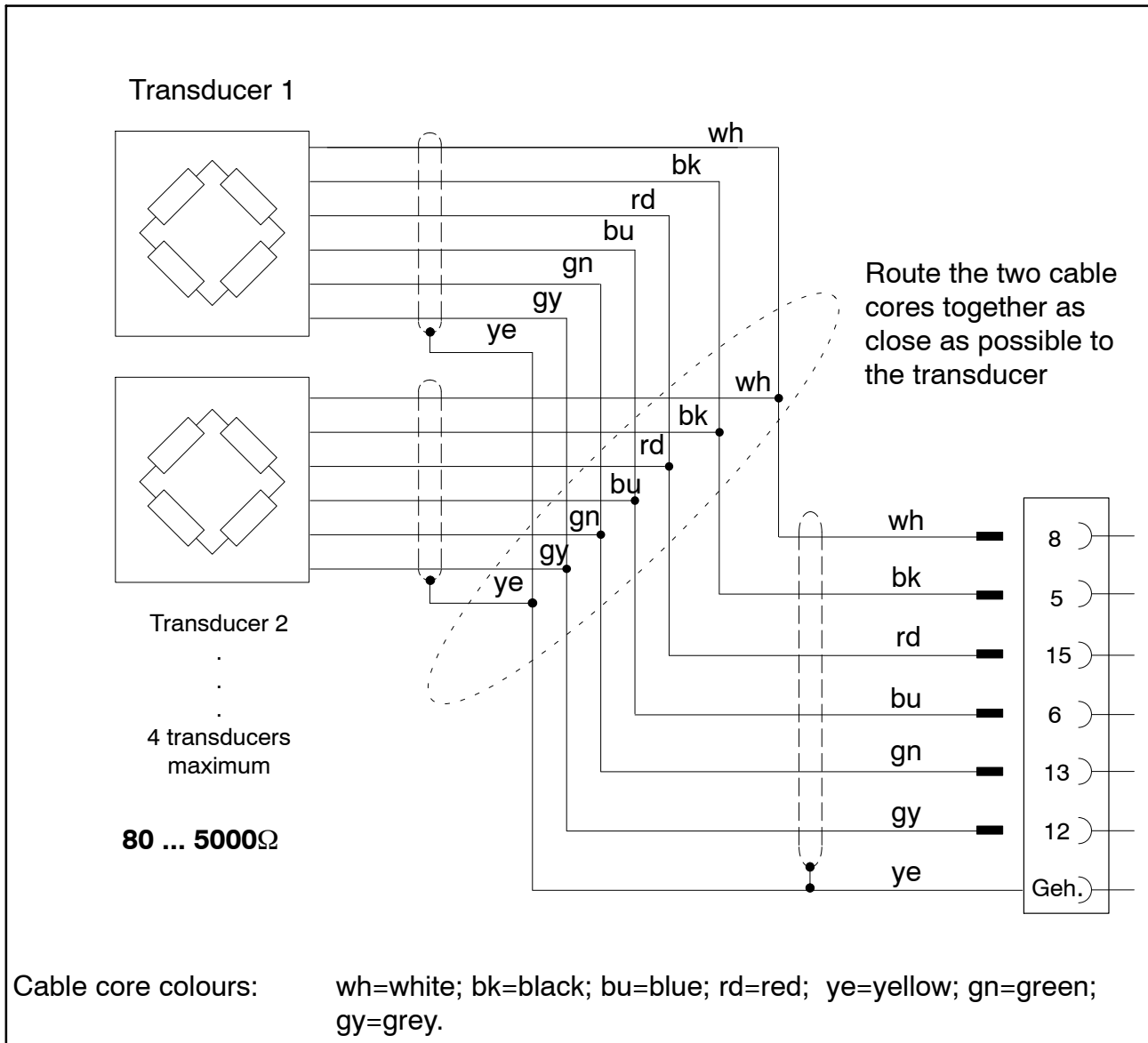
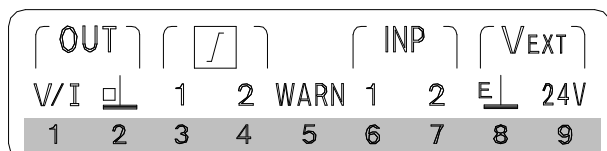

Fig. 5.4: Connection of parallel-wired transducers

5.3 Analogue output, Control inputs/outputs

The analogue output signal is present at terminals 1 and 2 as voltage (± 10 V) or current ($0 \dots \pm 20$ mA or $+4 \dots +20$ mA).

Use the plug bridges (jumpers) on the amplifier board to select current/voltage as described in chapter 3.2.1.



Refer to the below table for the terminals 1 to 9

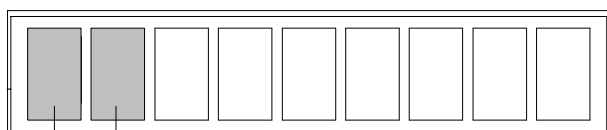

Analogue output signal

Input/Output	Terminal	Function	
←	1	Output signal (V/I)	± 10 V, ± 20 mA; $+4 \dots 20$ mA
←	2	Output signal (ground)	
←	3	Output limit-value 1	With positive logic corresponding to $V_{ext.}$ 24 V
←	4	Output limit-value 2	
←	5	Output Warning (Overflow)	Warning active for overflow and autocal. 24 V = OK 0 V = Warning
→	6	Input control-contact 1 (Function selectable)	see table on page 38
→	7	Input control-contact 2 (Function selectable)	
→	8	Ground (control outputs)	$V_{ext.}$ 0 V
→	9	Supply voltage (control outputs)	$V_{ext.}$ 24...30 V*

Note

The connections of the analog output voltage or current must be shielded . and the shielding must be connected to an EMC-tested control cabinet. The connection cables of the I/Os (Warning, LIV 1/2, INP 1/2, Ground, $V_{ext.}$) must not be longer than 30 m and may be laid only inside closed buildings.

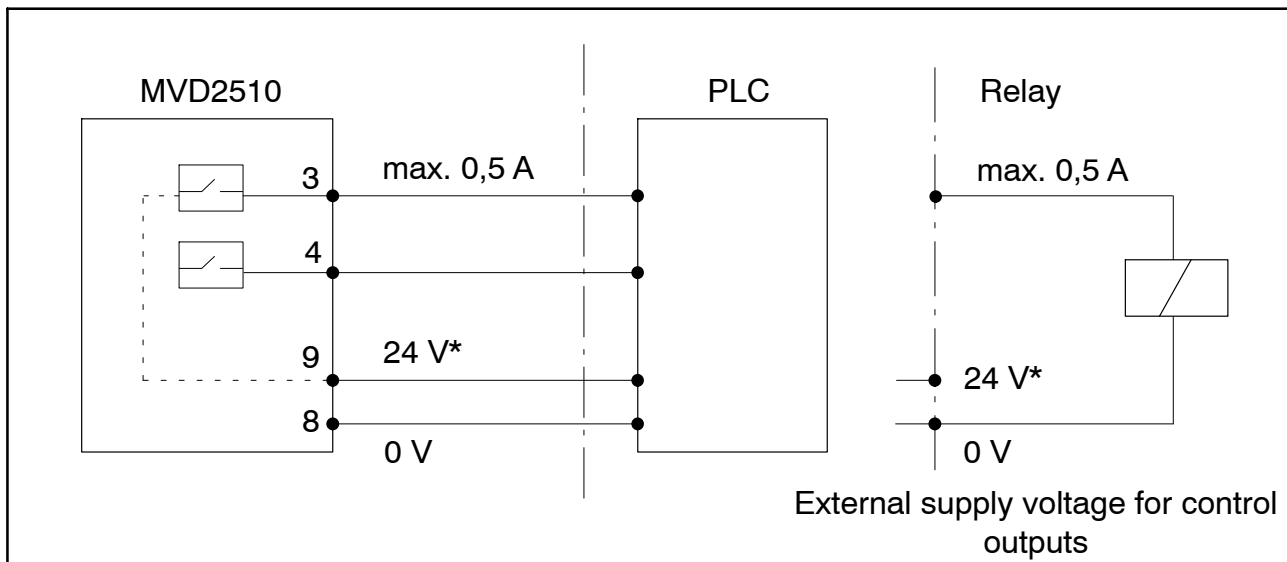

Fig. 5.5: Output configuration



WARNING

The control inputs and outputs on the terminal-strip socket (9 pins) are electrically isolated by optocouplers. The control outputs must be supplied with an external DC voltage (ground and 24 V) and must have protective separation from the mains (safety extra low voltage as per EN 61140 and IEC 61140 respectively; safety transformers as per EN 6155826 and IEC 6155826 respectively).

6 Adjustments and operation

6.1 Start-up and factory setups

Below we have listed some steps to be taken before starting up your measuring system (panel amplifier and transducer) and to enable a first functional test for all components to be made. This section mainly describes the adaptation of the MVD2510 to the transducer type used. In addition, some errors are mentioned that typically occur during device start-up.

- Install the device on your panel (see page 16)
- Proceed as described in chapter 4 to connect the mains cable and the transducer to the panel amplifier.



CAUTION

Observe the safety instructions!

- Connect the device to mains via an external switching device (mains switch).
- The device makes a functional test and then enters measure mode. The factory setups are activated.

Ex-works setting: The measurement range is set to a sensitivity of 2 mV/V and a display full-scale value of 10000 digits (see table on page 51).

- Press  . The ex-works setting is loaded.

Note

If the OFL error message is displayed, this may have the below reasons:

- *No six-wire feedback line connected*
- *Transducer/sensor not connected correctly*
- *No transducer/sensor connected*

Remedy: Switch device off. Connect the transducer correctly. Switch device on again.

- Use the  key to select the gross signal (NET is not displayed).

The device is now ready for operation. Carry out your settings, following Chapters 5 and 6.

6.2 Device operation and survey of keyboard functions

The operating concept differentiates between two types of key functions:

- keys that are effective during the measurement mode and
- keys that are effective in the programming mode.



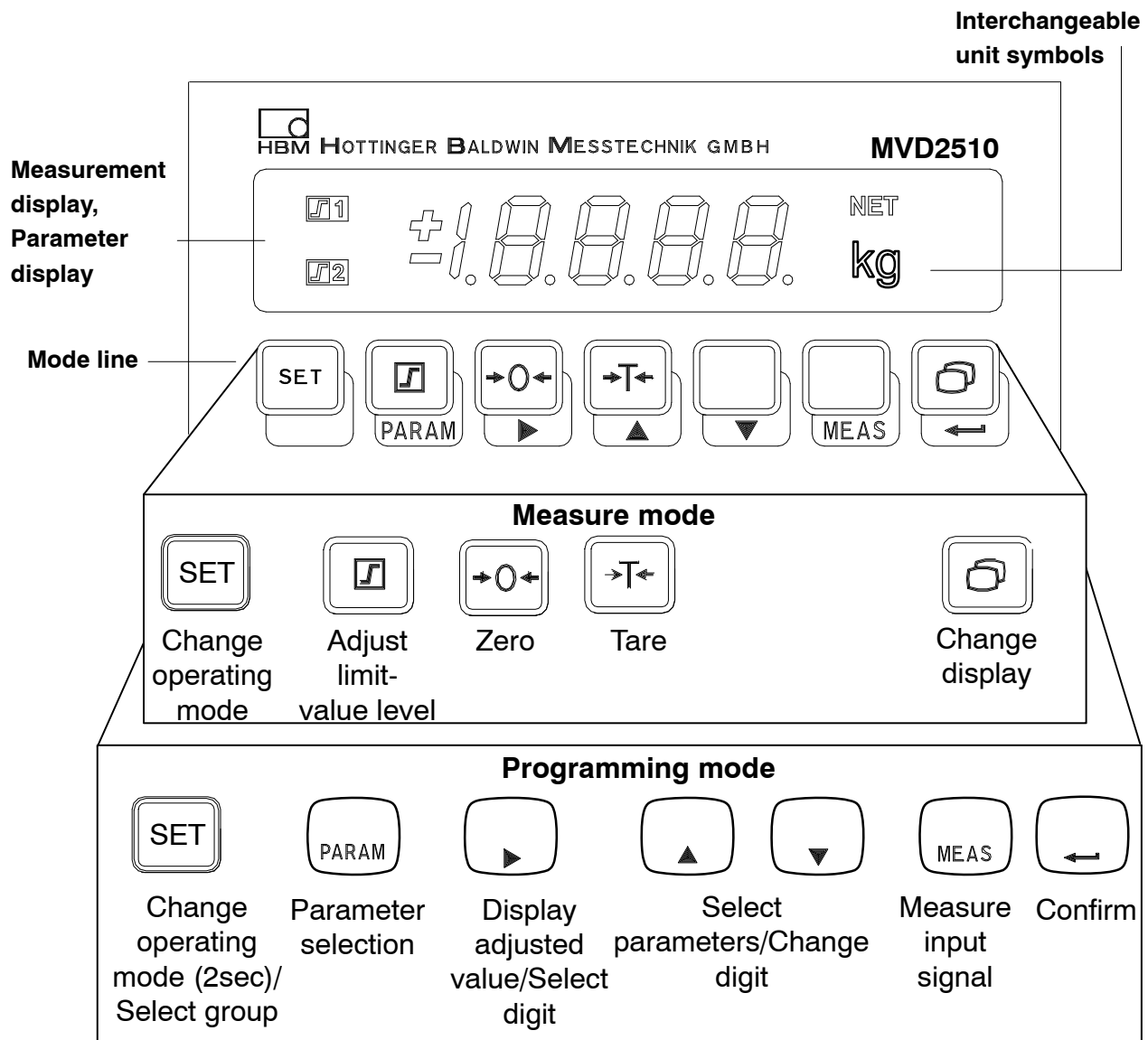

Each function key for Measure mode can be locked individually to prevent undesired key operation (see page 33).

Here also, a password may be entered to prevent undesired modifications.

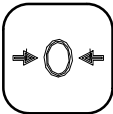

6.3 Functions in Measure mode

If necessary, all keys/functions in Measure mode may be locked to **prevent unauthorized manipulation**.

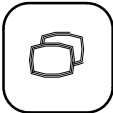
Key	Meaning				
	Permits to change from the Measure to the Programming mode (and vice versa) when pressed for about 2 sec.				
	Enables the limit-value levels (LIV1, LIV2) to be adjusted (see next page). The other limit-value parameters such as hysteresis, direction etc. are not changed. To enable changes to the limit-value level use LIV1,2/(b.Li) key (see page 33).				
	Is used for system zero-balance (also possible with control contact). The signal present at the input is taken as zero point.				
	Starts taring (also possible with control contact). The currently present measurement is used as tare value.				
	Changes measurement display between: <table border="0" data-bbox="453 1263 1187 1359"> <tr> <td>Gross value</td> <td>no display identification</td> </tr> <tr> <td>Net value</td> <td>"NET" is displayed</td> </tr> </table>	Gross value	no display identification	Net value	"NET" is displayed
Gross value	no display identification				
Net value	"NET" is displayed				

6.3.1 Adjust limit-value levels in the Measure mode

There are two possibilities for the selection of the limit-value level:

a) Enter numerical value for limit-value levels (Li)

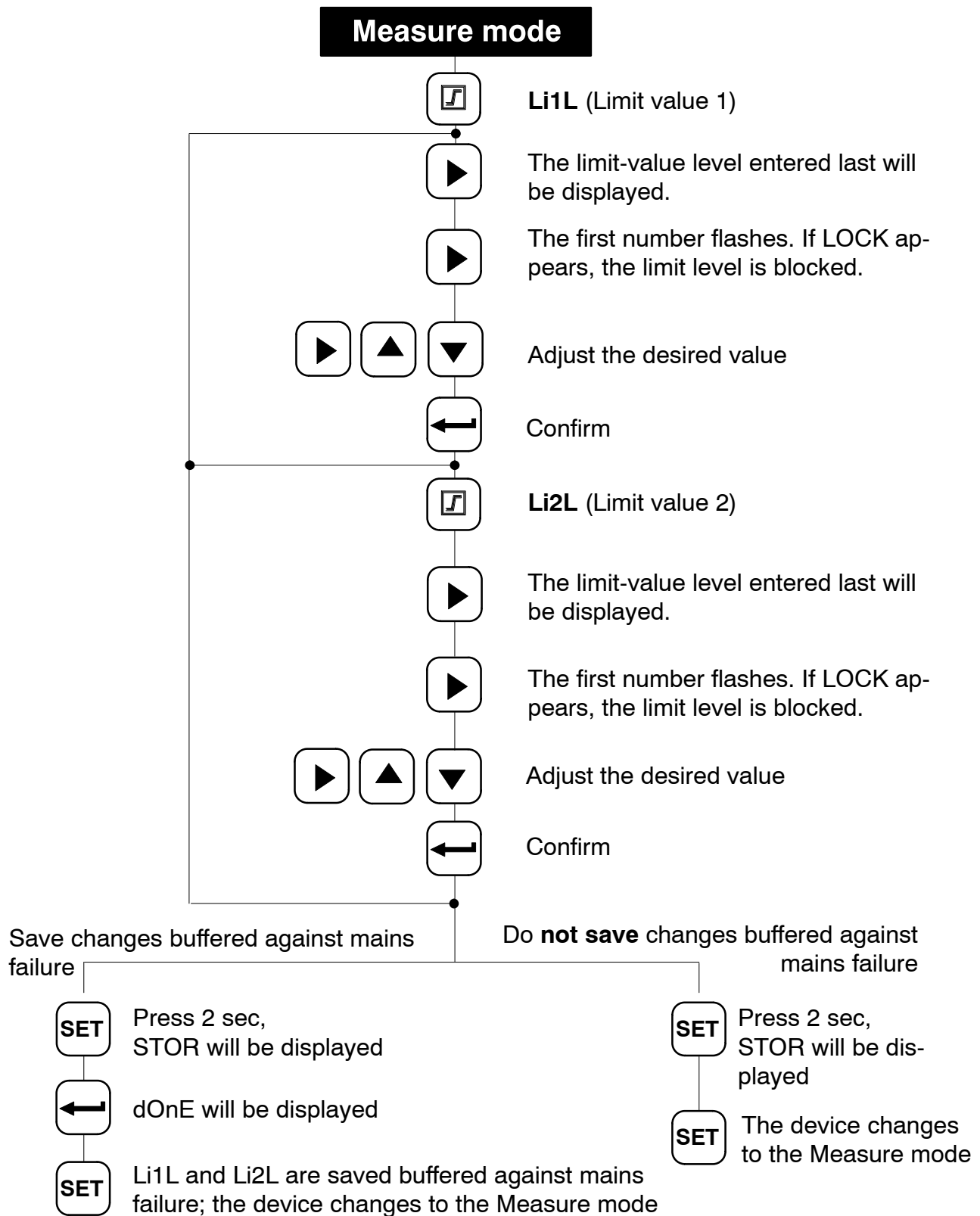

b) Accept signal present at the input as limit-value level

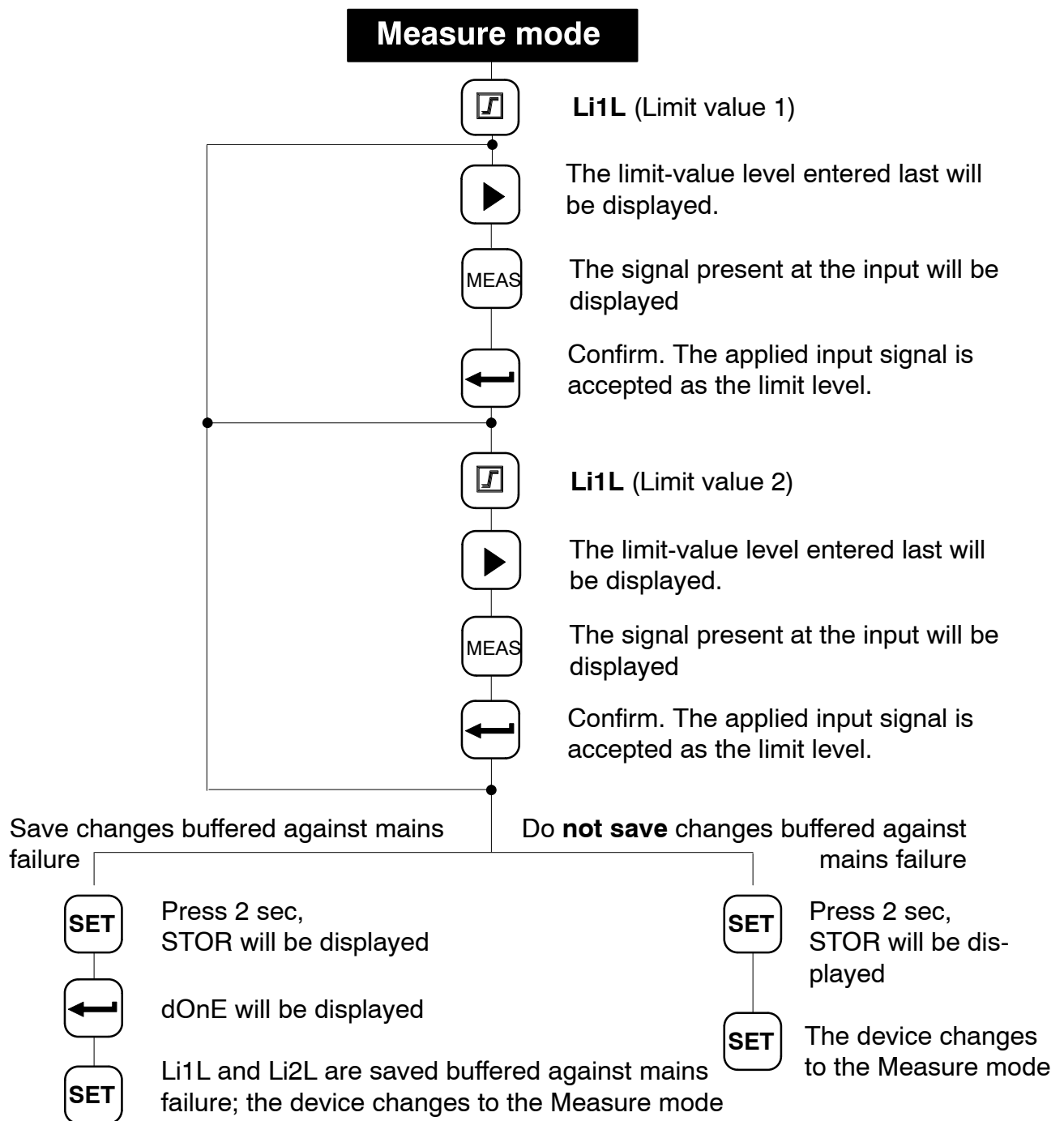







6.4 Programming mode

In the Programming mode  and 2  are flashing alternately.

This Operating mode enables all amplifier setups required for your application to be made. The parameters are grouped and codes are used for the group names.

Meaning of the keys:

-  Change operating mode, select group (e.g. CAL)
-  Parameter selection (e.g. INdc)
 The below three keys enable numerical values to be displayed or entered.
-  To display the value adjusted last. Press the key to select the desired digit.
-  To change the digit in ascending sequence.
-  To change the digit in descending sequence.
-  Measures input signal.
-  Confirms entry/change.

6.4.1 Change from the "Measure" to the "Programming" mode





- Press  for approx. 2 s.

The device changes from the "Measure" to the "Programming" mode if the password is 0000. This applies for the factory setup; **dIAL** will be displayed.

If a password has already been entered (different from 0000), then **Code** appears in the display on changing to "Program", i.e. the password is demanded.

Entering present password:

Code is shown in the display.







- Press  2x, the first number flashes
- Enter the valid password (four-figure number) with   
- Use  to confirm.

Upon entry of an unknown password, the device is reset to Measure mode. With the correct password, the first parameter group **dIAL** will be displayed.









6.4.2 Programming

Operation in the Programming mode









a) Select the value/parameter from a predefined table (Example dIAL-LAnG)

- Use  to select the group **dIAL**.
- Use  to select the parameter **LAnG**
- Press . The currently adjusted parameter will be displayed (e.g. dEut).
- Use  and  to select the new parameter (e.g. EnGL). The parameter change is signalled by display flashing.
- Use  to confirm.

b) Enter a numerical value as parameter (Example CAL-rnGE)

- Use  to select **CAL**.
- Use  to select the parameter **rnGE**
- Press . The measuring range in mV/V selected last will be displayed.
- Press  until the first digit is flashing; press again to select the next digit.
- Use  and   to adjust the desired value.
- Use  to confirm.

c) Accept transducer signal at defined load (Example CAL-rnGE)

- Use  to select **CAL**.
- Use  to select the parameter **rnGE**
- Press . The measuring range in mV/V selected last will be displayed.
- Press  (display with the selected unit).
- Press  until the first digit is flashing; press again to select the next digit.
- Use  and   to adjust the desired measuring range (predefined load).
- Use  to confirm. The measuring range in mV/V selected last will be displayed.



The setup procedure as described in c) is only permissible for the adjustment of zero value, measuring range and limit-value levels.

6.4.3 Change from the "Programming" to the "Measure" mode

When changing parameters the device queries whether the changed parameters should be saved buffered against **mains failure**.

- Press  for about 2 sec.

The device displays **STOR** to determine if the change is to be saved or not:

Save change: Press . dOnE will be displayed. Press . The device changes to Measure mode.

Do not save change: Press . The device changes to Measure mode.

CAUTION

The settings are only saved buffered against mains failure when they have been saved under one of the parameter sets.

6.5 Information on groups and parameters

		<div style="display: flex; align-items: center;"> <div style="border: 1px solid black; border-radius: 50%; padding: 2px 5px; margin-right: 5px;">SET</div> → <div style="margin-left: 10px;">Groups</div> </div>					
		<div style="display: flex; align-items: center;"> <div style="border: 1px solid black; border-radius: 50%; padding: 2px 5px; margin-right: 5px;">PAR</div> ↓ </div>	diAL (Dialog)	PARA (Parameter set)	CAL (Calibration)	Li.1 (Limit value 1)	Li.2 (Limit value 2)
Parameters	LAnG Language	rEcA Load	INdc Nominal value	FrEE Enable		A.SIG Output signal	P__ Firm-ware PXX
	COdE Password	Store Save	dEc.P Dec.point	Sour Source		U_I U/I	
	b.Li Taste GW	Au.St Zero/Tare value	StEP Digit step	dir Direction		tEst Test	
	b.ZEr Zero key		zEro Zero value	Li.Le Level		rE.1 Contact 1	
	b.tAr Tare key		rnGE Measuring range	HYSt Hysteresis		rE.2 Contact 2	
	b.SIG Signal key		tArA Tare value	LoGc Logic		L_r Remote control	
			FILt Filter	bu.Li Limit-value key			

6.5.1 Dialog (dIAL)

Select language (LAnG)

The below dialog languages are selectable:

dEUt	German
ENGL	English
FrAN	French

Set password (CodE)

When changing from **Measure** to **Program**, the password is demanded (see page 29).

The password guards against unauthorised MVD2510 operation. Parameters can only be changed when the valid password is entered. A change of password is possible if the old password is known.

coDE	Function
0000	no password; factory setup
001 ... 9999	password adjusted

Enable/lock keys (b.Li, b.ZEr, b.tAr, b.SIG)

LIV key (b.Li):  may be enabled (FrEE) or locked (LOCK)

Zero key (b.ZEr):  may be enabled (FrEE) or locked (LOCK)

Tare key (b.tAr):  may be enabled (FrEE) or locked (LOCK)

SIGN key (b.SIG):  may be enabled (FrEE) or locked (LOCK)

6.5.2 Load/Save in parameter set (PArA)

The device setups (factory setup or parameter set 1) can be stored in an EPROM that is protected from power failure and can be loaded if required. When changing from Programming to Measure with changed parameters there is a prompt asking if the changed parameters are to be stored.

rECA: To load parameter set 1 (PAr.1) or factory setup (SEtu)

Stor: To save parameter set 1 (PAr.1)

Au.St: Zero value/Tare value OFF or ON:

OFF	Zero and tare values are lost during a mains failure
ON	Zero and tare values are also retained during a mains failure

6.5.3 Calibration (CAL)

Nominal value (INdc)

The transducer's full scale can be adjusted (Scale range ± 19999). A full scale value (e.g. 10.000 KN) is assigned to an input-signal range, e.g. 2 mV/V.

Decimal point (dEc.P)

The decimal-point position is changed.

Selectable positions	.0000	0.000	00.00	000.0	0000
----------------------	-------	-------	-------	-------	------

Step width (StEP)

Here, the step width or the digit step can be selected.

Selectable step widths	1	2	5	10	20	50	100	200	500	1000
------------------------	---	---	---	----	----	----	-----	-----	-----	------

Zero value (zEro)

A value for the measuring system's zero balance is adjusted (unit mV/V).

Possible input: From $\pm 0.2 \dots 3.8$ mV/V.

Meas. range(rnGE)

A full-scale value (unit mV/V) can be adjusted. If the adjusted value is not within the input range, the minimum or maximum permissible value will be adjusted:

Possible input: From $\pm 0,2 \dots 3,8$ mV/V.

Tare value (tArA)

A tare value (related to full-scale) can be defined.

Example: Displayed value 10.000 kg is tared to 5.000 kg.

Filter (FILt)

Various low-pass filters (Bessel characteristic) can be selected.

Filter frequency (Hz)	0,05	1,0
	0,1	2,0
	0,2	5,0
	0,5	

6.5.4 Limit values (Li1, Li2)

The parameters for limit-value adjustment are grouped for each limit value. The limit values' state is indicated on the display and transmitted via control outputs.

The below figure illustrates the limit values' function and the parameters:

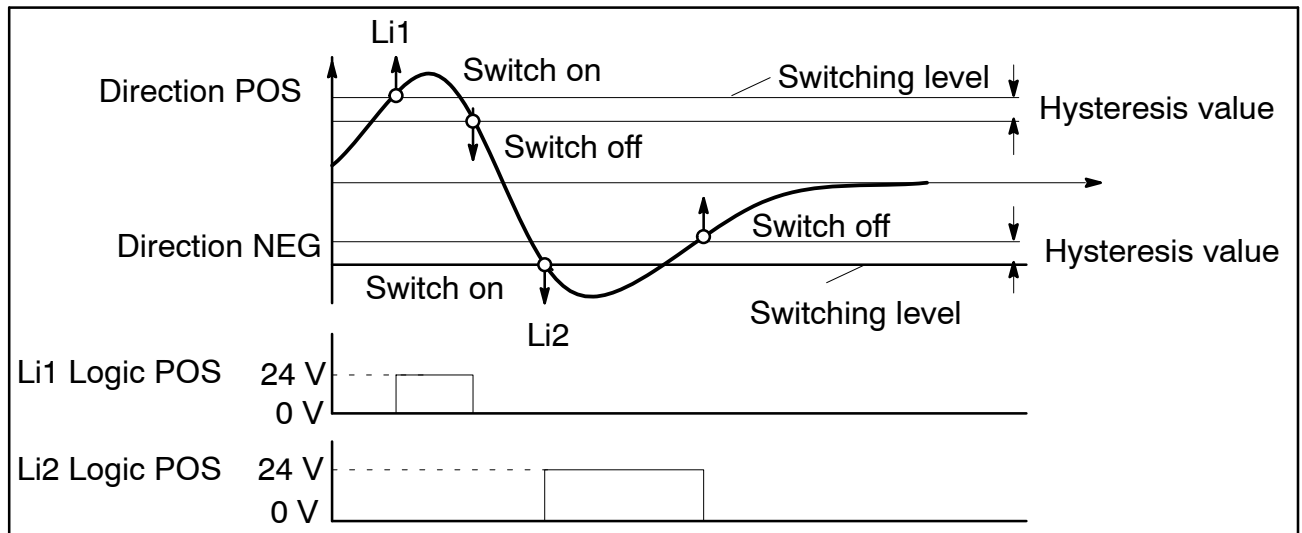

Fig. 6.1: Functions and parameters for the limit values

Enable/Lock limit values (FrEE)

The limit values can be enabled (EIn) or locked (AUS) individually.

OFF	Inhibit limits individually
ON	Inhibit limits individually

Source (Sour)

Limit value weighting:

groS	Gross value
nET	Net value

Direction (dlr)

Here, the switching direction or the operating direction is specified (see Fig. 6.1).

POS	positive	Switch-on threshold higher than switch-off threshold for increasing measurement
nEG	negative	Switch-off threshold higher than switch-on threshold for decreasing measurement

Level (PEGL)

The level is adjusted in display units (e.g. 2.000 kg).

Hysteresis (HYSt)

The hysteresis is entered to prevent a "fluttering" of the limit-value switch when the switching threshold is reached. The hysteresis results from the differential between switch-on and switch-off threshold.

A value is set in display units, e.g. 0.200 kg.

Output logic (LoGc)

The control contacts' output logic can be modified as desired. The below definition is valid:

POS	positive	Switch on = High Switch off = Low
NEG	negative	Switch off = High Switch on = Low

Limit-value key (buLi)

A limit-value-level modification with  can be enabled (FrEE) or locked (LOCK).

6.5.5 Inputs and outputs (I_O)

This menu enables the setups required for the MVD2510 input signal, the analogue output and the control contacts to be made.

Output signal(A.SIG)

The output signal weighting:

groS	Gross value
nET	Net value

Analogue signal (U_I)

Note

Use jumpers on the amplifier board to select current output or voltage output. Refer to page 14 for a description of the procedure.

Depending on the selected analogue signal the below options are possible:

	Display	Meaning
Current		
Off	OFF	–
On	0_20	± 20 mA output
	4_20	+4.. 20 mA output
Voltage		
Off	OFF	–
On	10 U	± 10 V output

MVD input signal (tEst)

This function is used to check the internal calibration and zero signals.

The following input signals can be selected:

MES.S	Measuring signal	Measure mode
CAL.S	Calibration signal	A calibration signal (50 %) is connected to the input
zER.S	Zero signal	Ground is connected to the input

Control contact 1..2 (rE.1 /rE.2)

You have contacts available on terminals 6 and 7 on the terminal strip socket (9-pole) for the control of some MVD2510 functions. The control contacts may be assigned as desired. The factory setup for the contacts is "No function".

Function	Display	Level 0 V/24 V
no function	- - -	No function (factory setup)
Tare	tArA	Upon transition 0 V - 24 V tare value is stored
Set zero	zEro	Upon transition 0 V - 24 V the current input signal is stored as zero value
Lock keyboard	bu.Lo	0 V: keyboard not locked; 24 V: keyboard locked

Remote control (StEU)

Remote control can be enabled (ON) or locked (OFF).

OFF	Operation only via keyboard
ON	Operation via keyboard and contacts

6.5.6 Additional function (InFO)

Firmware (P--)

To support you in the case of technical problems, this parameter includes the firmware version. Please specify the firmware version when contacting our service department.

Example: P 10 Firmware version P10

7 Example

The below example uses a measurement task to show the device functions and the required setups.

Measurement task: Filling a container

Containers are filled by weighing on a platform weighing machine. The platform is fitted with a load cell with a measurement range of 100 kg (corresponding to 2 mV/V). The weight of the platform itself is not known, but it is less than 10 kg. The empty weight of the container is about 10 kg. The containers are placed singly on the platform, tared and filled with 52 kg.

Balancing

Weighing machine adjustment with a partial weight of 50 kg

Platform weighing range (display full-scale value): 80 kg.

Number step: 1

Filter setting: 2 Hz

Limits

The container is filled with a net weight of 52 kg (Set value of Li1). If 2 kg (Limit Li2) is undercut, a signal is produced that there is no container on the weighing machine (referred to gross value).

The hysteresis for both limits is 0.5 kg.

Changes to the Li1 limit threshold should be able to be carried out by the operator using the direct key . Limit 2 should not be changed for safety reasons.

Other details

In order to prevent unauthorised changing of the parameters, the access to the settings is only possible with a password (e.g. 1510).

The net signal should be available as an analogue signal (4...20 mA).

Changing of the zero point via the keyboard should not be possible.

Taring is carried out via the external Control Contact 1 or with . The second contact has no function. Remote control is not provided. The zero point and tare values should be saved buffered against mains failure.

Explanation of symbols



Group



Parameter

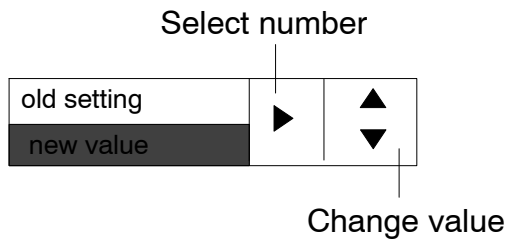

Measure mode



Password query (see page 29)

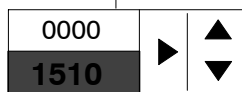

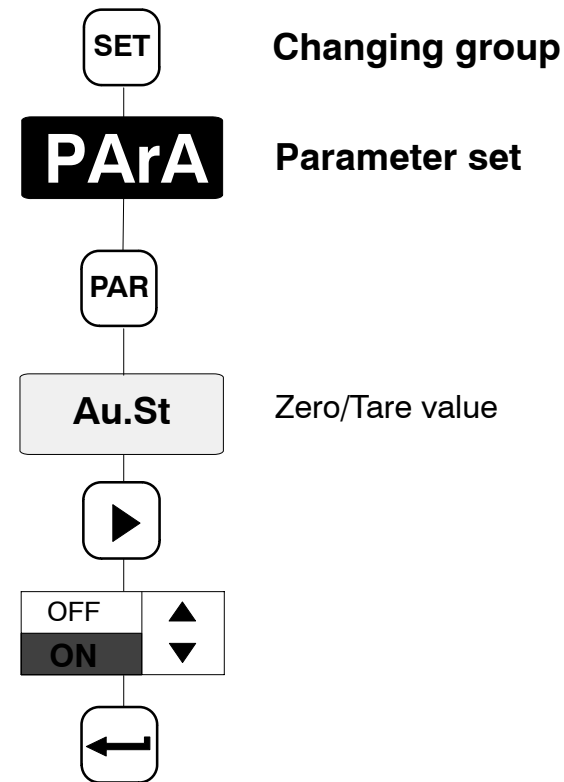
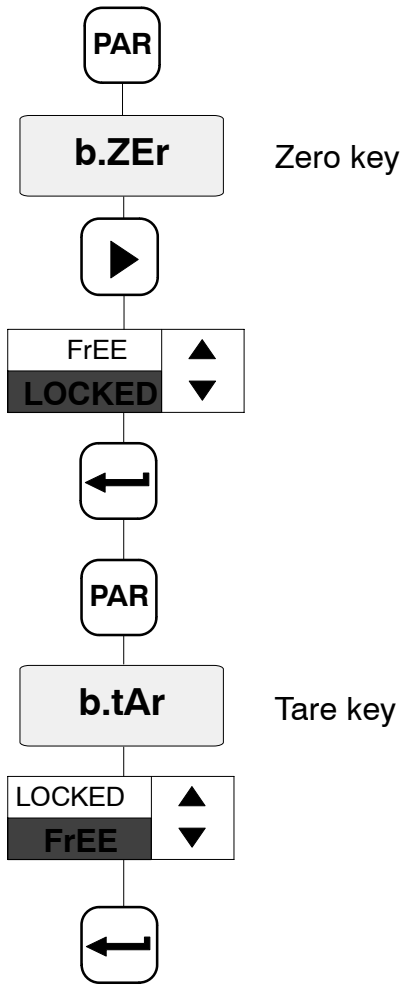

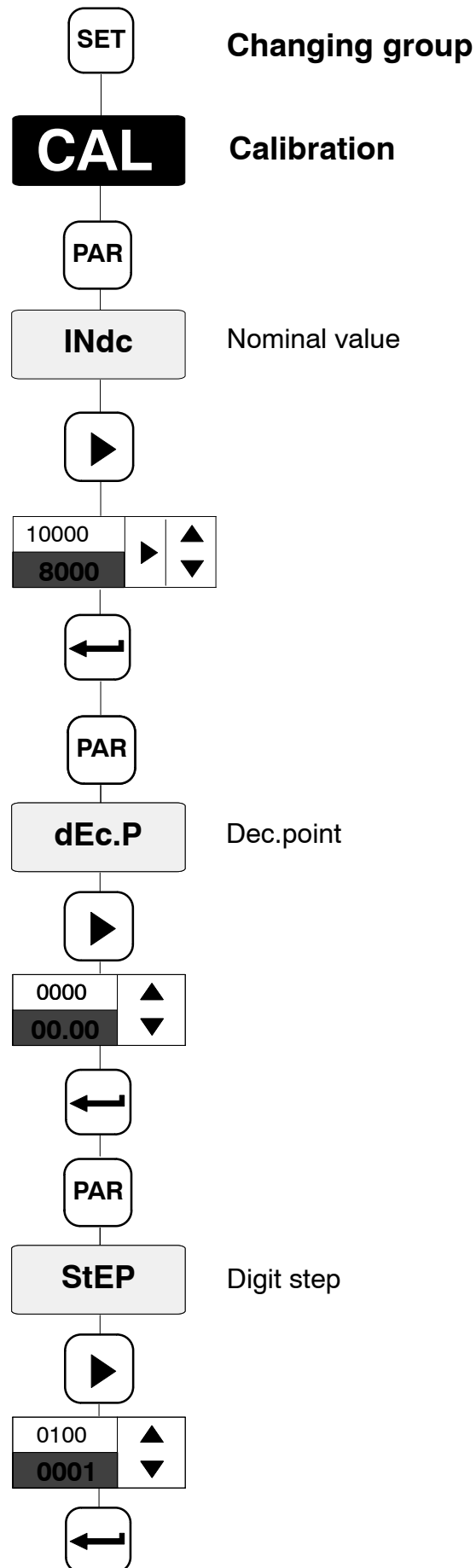

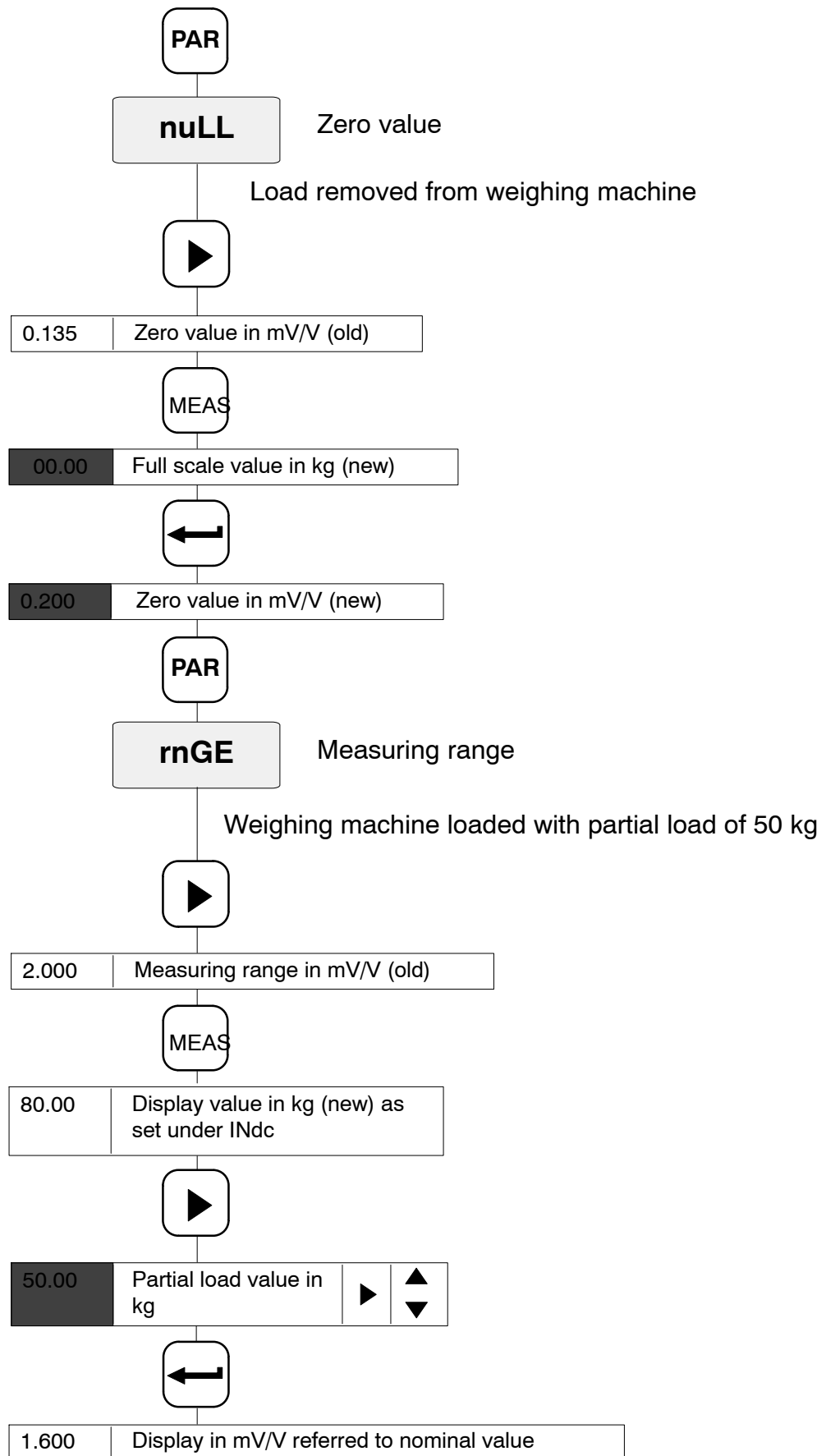

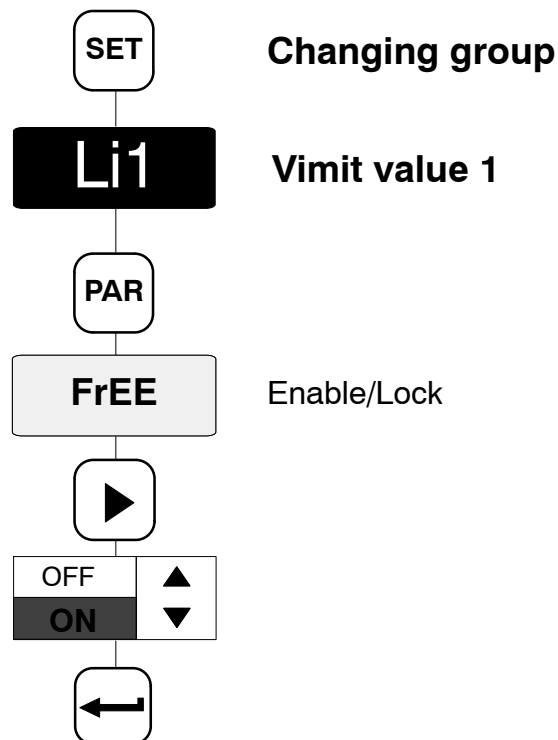
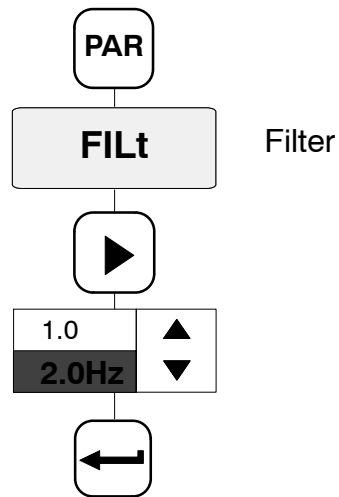

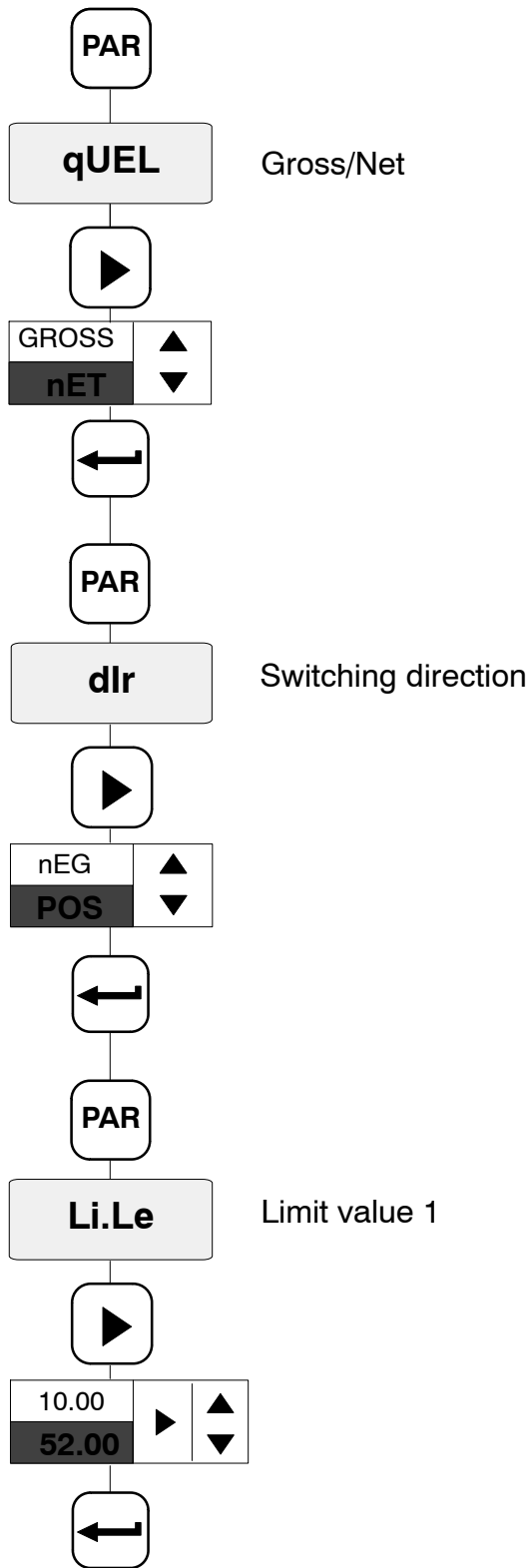

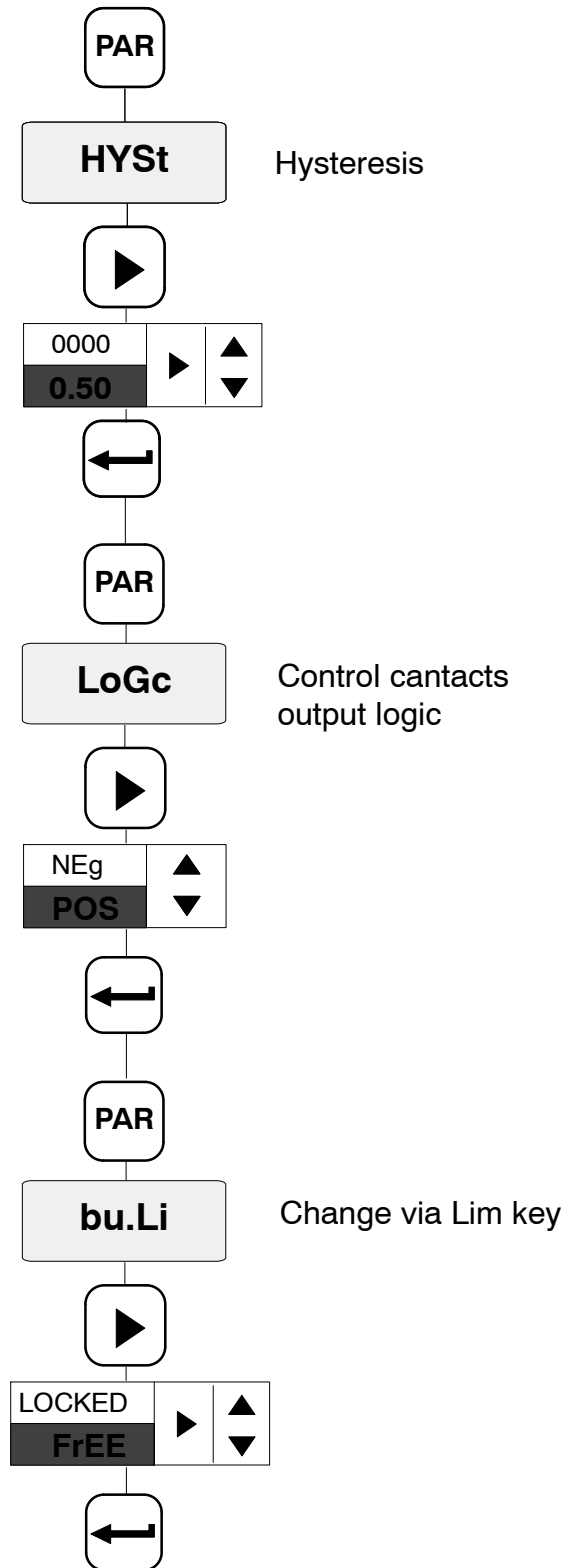

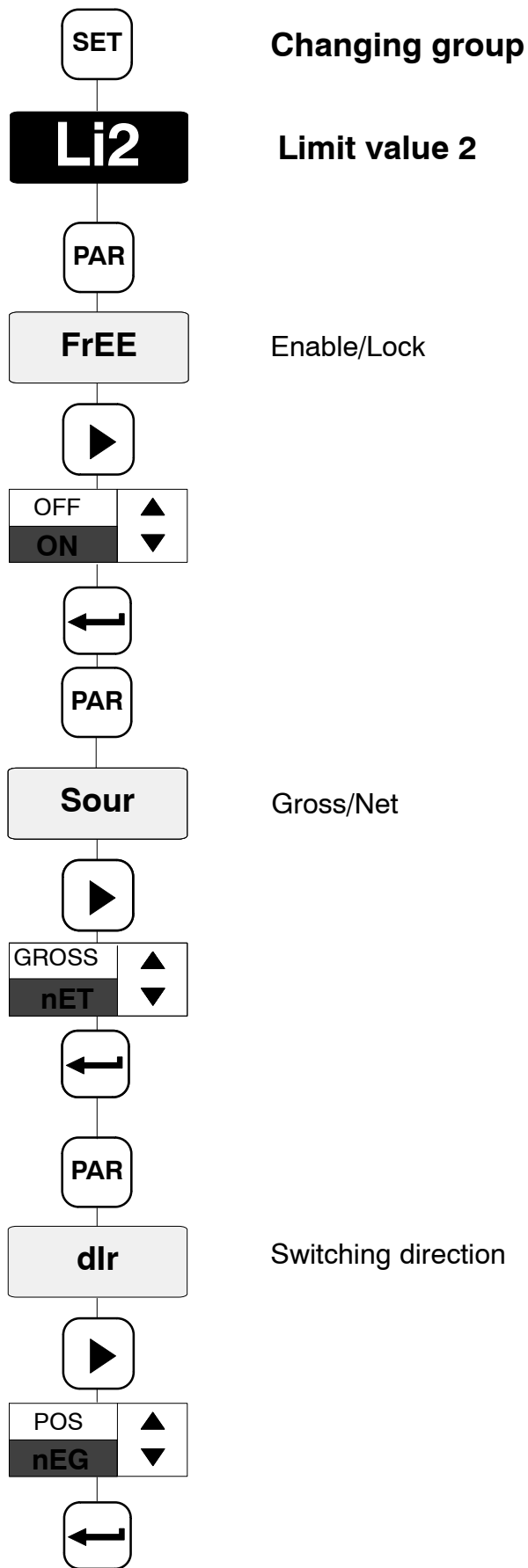

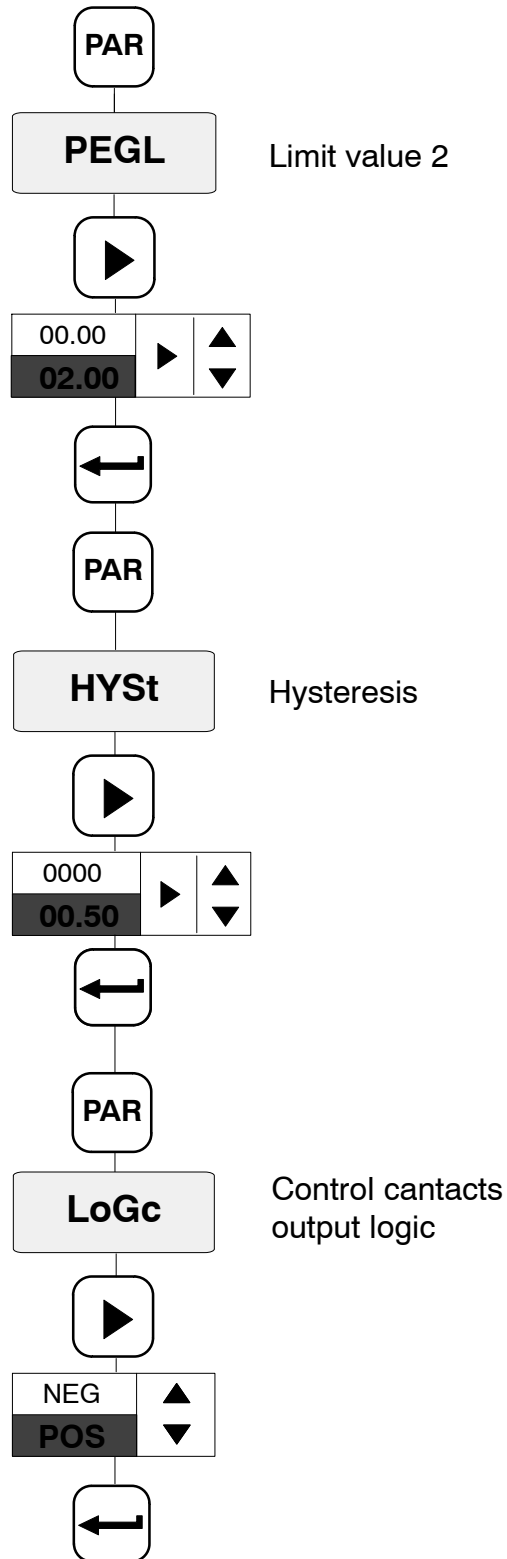

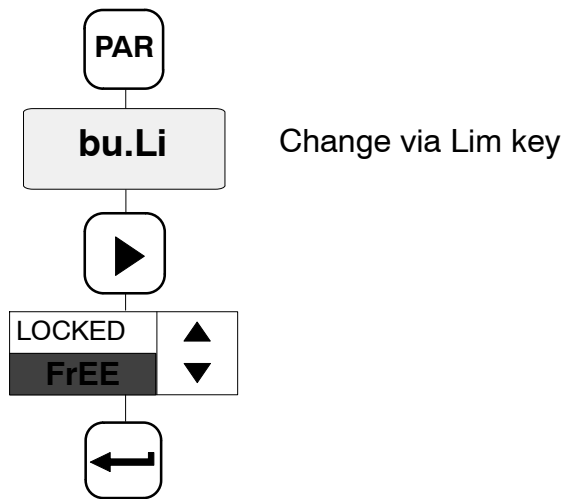

Change via Lim key

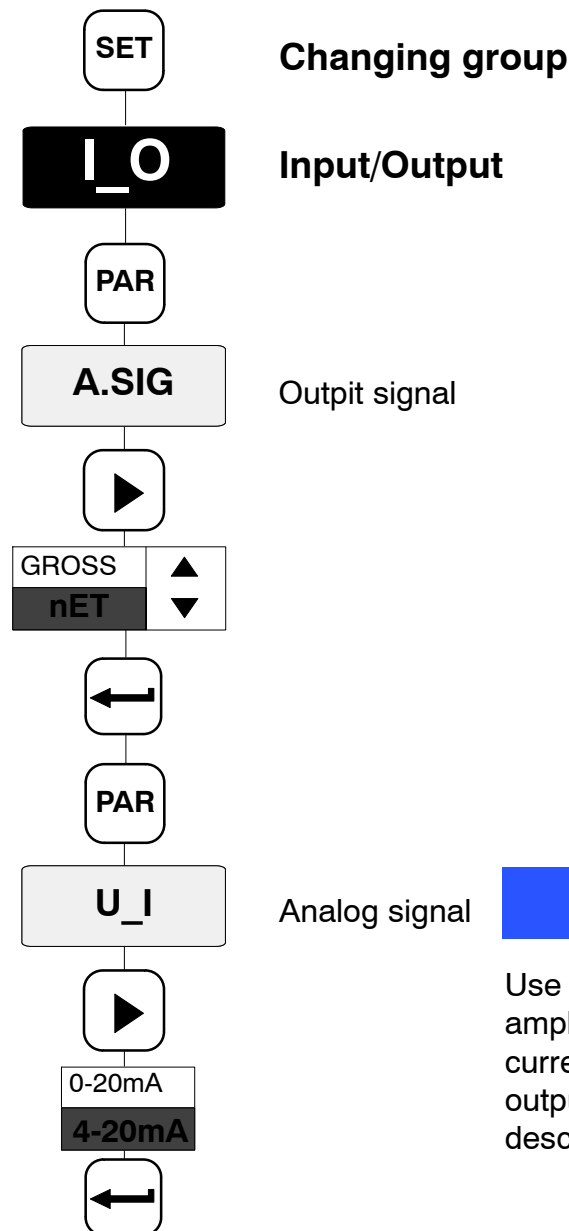

Changing group

Input/Output

Output signal

Analog signal

NOTE

Use plug bridges on the amplifier board to select current output or voltage output. Refer to page 14 for a description of the procedure.

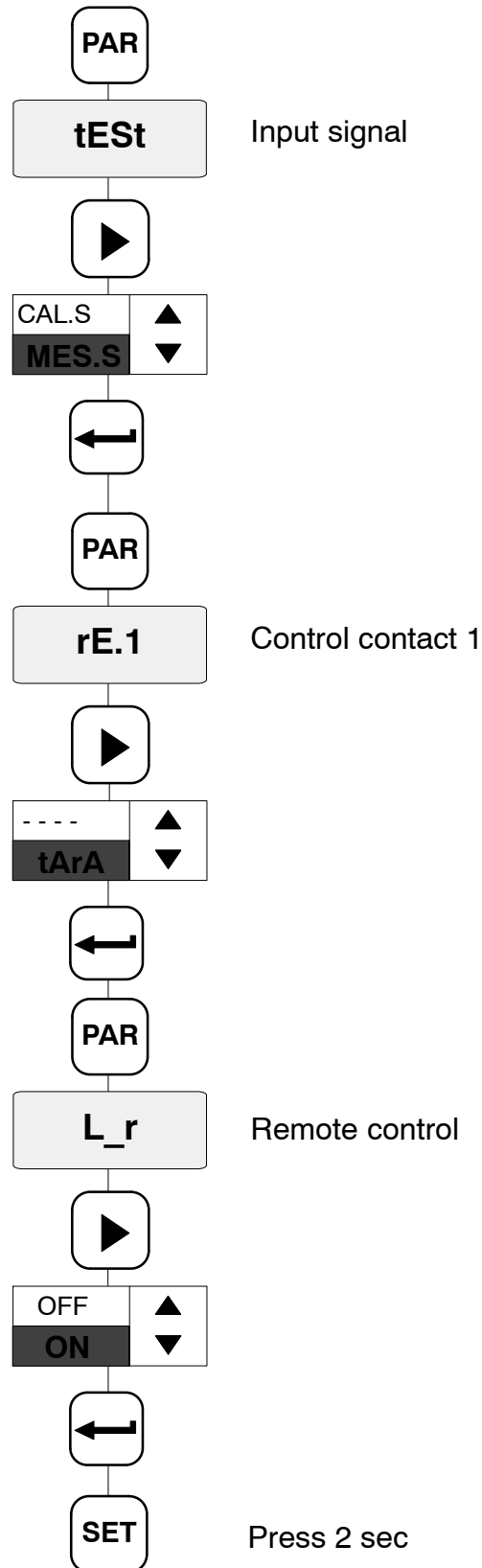

8 Displays and ex-works settings

Display	Meaning	Factory setup	
dIAL	Operating dialogue		
LanG	Dialog-Language	dEut	
CodE	Password	0000	
b.Li	Limit value key	FrEE	
b.ZEr	Zero key	FrEE	
b.tAr	Tare key	FrEE	
b.SIG	Signal key	FrEE	
PArA	Parameter set		
rEcA	Parameter set or factory setup	SeTU	
Store	Store Parameter set	PAr.1	
Au.St	Zero value and Tare value	OFF	
CAL	Calibration		
INdc	Nominal value	10.000	
dEc.P	Decimal point	0.000	
StEP	Step width	0001	
zEro	Zero value	0.000 mV/V	
rnGE	Measuring range	2.000 mV/V	
tArA	Tare value	0.000	
FILt	Filter	5.0 Hz	
Li1/Li2	Limit values 1, 2	Li1	Li2
FrEE	Enable	OFF	
Sour	Source of Input signal	GROSS	
dlr	Switching direction	POS	nEG
PEGL	Level in display unit	10.000	-10.000
HYSt	Hysteresis	1.000	
LoGc	Control contacts output logic	POS	
bu.Li	Limit value key	FrEE	

I_O	Input/Output signals	
A.SIG	Source of Output signal	GROSS
U_I	Analog signal	10 V
tEST	Input signals	MES.S
rE.1	Control contact 1, 2	---
L_r	Remote control	---
InFO	Additional functions	
P__	Firmware	

9 Error messages

Error message	Reason	Remedy
LOCKED	The specified value cannot be changed.	Enable limit-value change
OFL	Transducer/sensor not connected properly: No transducer/sensor connected No six-wire feedback line connected	Connect the transducer properly. Switch off device and switch it on again.
Fehl	Transmission error upon storage	-
1----	Display value exceeded, amplifier not yet overloaded	-
Knfl	Setup does not match hardware setup	Check and adapt current/voltage setup
 No key reaction	Key is locked	Enable key in dIAL b.Li

10 Keyword index

A

Accept transducer signal, 31
Adaptation to transducer, 39
Additional function , 38
Adjust limit-value levels, in the Measure mode, 26
Analogue output, Current, Voltage, 14, 21
Analogue signal , 37

B

Balancing, 39

C

Calibration , 34
Change, factory setup, 13
changing parameters, 31
Connection, 18
 four-wire technique, 19
 Parallel connection, 19
 S/G full brige, 19
 six-wire technique, 19
Control contact , 38
Control inputs, Configuration, 22
Control outputs, Configuration, 22
Current output, Select, 14
current output , select, 37, 49

D

Decimal point , 34
Device rear, 17

E

Enable/lock, keys , 33
Enable/Lock , limit values , 35
Enter numerical value, 30
Entering present password, 29

Error message, 23
Example for measurement, 39

F

Factory seting, 51
Factory setup, 12, 22
 load/save, 33
Filter, 34
Firmware, 38
Full scale, 34
Function key , 24
fuse, Position on the board, 14

G

Gross, 23, 25, 37
Gross value, 35

H

Hysteresis, 35
Hysteresis , 36

I

Input signal, 37
Inputs/Outputs , 37
Install amplifier on panel, 16

L

Level , 36
Limit value, 35
Limit-value key , 36
Limit-value level, Change, 36
Limit-value levels , 25
Limits, 39
Logic, 21
Logik, 35

M

Measure mode, 29, 31
Measure mode , 25

N

Net, 25, 37
Net value, 35
Nominal value , 34

O

Operating concept, 24
Output logic , of the control contacts, 36
Output signal, 37

P

Panel, Installation, 16, 22
panel mounting , 11
Parallel connection, 19
Parameter set, Load/Save, 33
Password, 29, 33
Password , 24
plug bridges , 37, 49
plug-bridge arrangement, 13
Plug-bridges
 Position on the board, 14
 Select current/voltage, 14
Plug-in strips, 15
Programming, 28, 30

Programming mode, 29, 30, 31

R

Remote control , 38

S

S/G full bridges, Connect, 19
Select language , 32
Select parameters, 30
SET, 25, 28
Start-up , 22
Step width , 34
Switching direction, 35

T

Tare value , 33, 34
Taring, 25
Terminal, 9-pin terminal-strip socket, 21
Terminal allocation, 21
Terminal-strip connector, 18
Terminal-strip socket, 18, 38

V

Voltage output, select, 14, 37, 49

Z

Zero balance, 25
Zero value, 33, 34

© Hottinger Baldwin Messtechnik GmbH. All rights reserved.
Subject to modifications.
All product descriptions are for general information only. They are not to be understood as a guarantee of quality or durability.

Hottinger Baldwin Messtechnik GmbH
Im Tiefen See 45 • 64293 Darmstadt • Germany
Tel. +49 6151 803-0 • Fax: +49 6151 803-9100
Email: info@hbm.com • www.hbm.com

measure and predict with confidence

