

Operating Manual

English

MP85A Program Help



Hottinger Baldwin Messtechnik GmbH
Im Tiefen See 45
64239 Darmstadt
Tel. +49 6151 803-0
Fax +49 6151 803-9100
info@hbm.com
www.hbm.com

DVS: a3387-1.1 HBM: public
12.2016

© Hottinger Baldwin Messtechnik GmbH

Subject to modifications.

All product descriptions are for general information only.
They are not to be understood as a guarantee of quality or
durability.

Contents		Page
1	Quick start	9
1.1	The MP85A measuring system	9
1.2	What needs to be done?	10
1.3	Setting up the hardware	11
1.4	Firmware update	12
2	SYSTEM settings	15
2.1	General settings	15
2.2	Using passcodes	17
2.3	Interface parameters	18
3	Prepare MP85A for your application	23
3.1	Setup of the measuring chain (MP85A and transducer)	23
3.1.1	Specifying a transducer	25
3.1.2	Adjusting the measuring chain	29
3.1.3	Signal conditioning (zero balance, low-pass filter)	40
3.2	What needs to be considered when zero balancing and how long does it take?	42
3.3	How are the sample rate and filter settings connected?	43
3.3.1	Transducer test	43
3.3.2	What is the procedure for a transducer test and what needs to be considered?	45
3.4	Additional functions	45
3.4.1	Limit values	45
3.4.2	Digital outputs	47
3.4.3	Digital inputs	51
4	Settings for monitoring using tolerance windows	55
4.1	Principle procedure	56
4.2	The Configure evaluation parameter window	58
4.3	Control settings	60
4.3.1	Maximum measuring time	61
4.3.2	Start conditions	62

4.3.3	Stop conditions	62
4.3.4	End conditions	66
4.4	Alarm window	71
4.5	Range window	72
4.6	Test measurement (start measurement manually)	74
4.7	Important information about tolerance windows	76
4.8	Defining tolerance windows	79
4.8.1	Creating and modifying tolerance windows	80
4.8.2	Window active	82
4.8.3	Consider window result in total result	82
4.8.4	Crossing window with min/max evaluation	83
4.8.5	Crossing window with evaluation of the y mean	83
4.8.6	Crossing window with evaluation of the x mean	84
4.8.7	y limit	85
4.8.8	x limit	86
4.8.9	Block window (end window)	87
4.8.10	Switch test	87
4.8.11	Haptic test	89
4.8.12	Evaluation in real time window option (online window)	91
4.8.13	Consider window sequence	93
4.8.14	Window option y coordinates relative	99
4.8.15	Window option x coordinates relative to	101
4.8.16	Evaluation for entry and exit of window	104
4.8.17	Statistics and distribution (bin counting)	113
5	Monitoring with tolerance band: settings	119
5.1	Principle procedure	120
5.2	The Configure evaluation parameter window	122
5.3	Control settings	124
5.3.1	Maximum measuring time	125
5.3.2	Start conditions	126
5.3.3	Stop conditions	126
5.3.4	End conditions	130
5.4	Alarm window	135
5.5	Range window	136

5.6	Test measurement (start measurement manually)	138
5.7	Defining a tolerance band	140
6	Monitoring with envelope curve	143
7	Saving results, data storage	145
7.1	Storage medium MultiMediaCard/SD Card (target MMC/SD Card internal)	146
7.2	Storage medium external (storage via CAN bus or Ethernet)	148
7.3	Storage methods	149
7.4	Files to save	150
7.5	File names and directories	151
7.6	File formats	153
7.7	Save statistical data, statistical processing	157
8	SAVE/LOAD PARAMETERS	159
9	MEASURE + VISUALIZE	165
9.1	Display current values (measurement display)	165
9.1.1	Possible error messages and instructions for correction	168
9.1.2	What limitations apply for (transducer) scaling?	171
9.2	Measurement curve	171
9.3	Results of the last measurement	176
9.4	Statistics	177
9.4.1	3D graph	178
9.4.2	Distribution (bin counting)	179
9.5	Retrieve saved data	180
9.6	Files on MMC/SD Card (copy to/from PC)	183
10	Plus tools	185
11	Options	187
11.1	Change log	187
11.2	Display connection loss detection	187
12	FAQ: Questions and answers about MP85A and PME Assistant	189
12.1	How do I adjust the interface on the MP85A?	189
12.2	How do I set the IP address on my PC?	192

12.3	How do I connect the PME Assistant to the MP85A?	195
12.4	How do I recognize the file system on my PC and which should I use?	196
12.5	How do the options in the start window of the PME Assistant work?	197
12.6	What happens when connecting additionally to an existing Ethernet connection?	199
12.7	Requirements for MMC/SD Cards	200
12.8	How are the sample rate and filter settings connected?	201
12.9	What does the data reduction do and how do I set it up?	201
12.10	What possibilities are there to start, stop and end the measurement?	205
12.11	How do I work when setting up the evaluation criteria?	219
12.12	What needs to be considered when zero balancing and how long does it take?	220
12.13	What is the procedure for a transducer test and what needs to be considered?	221
12.14	What limitations apply for (transducer) scaling?	222
12.15	What has to be considered with parameter set switching?	223
12.16	How to determine changes to the device settings?	224
12.17	Which error messages exist for the measuring/the process status and how can I correct errors?	224
12.18	What do the error messages with tolerance window violation mean?	226
12.19	What do the LEDs on the MP85A mean?	234
12.20	What should be observed when saving process data, curves or process results?	236
12.21	How does the timing diagram for a process-optimized measurement look like?	238
12.22	How does the timing diagram for a measurement with no data loss look like?	239
12.23	How can a digital output be set?	239
12.24	How do I create a protocol printout of a process?	240
12.25	How to transfer all MP85A settings to another device (cloning)? . . .	241

12.26	How do I carry out a firmware update and can the update be prevented?	242
12.26.1	Download firmware update	242
12.26.2	How to update the firmware	243
12.27	What does a tolerance band look like?	243
12.28	What does an envelope curve look like?	244
12.29	What is TEDS?	244
13	Index.	247

1 Quick start

The help for the PME Assistant consists of three parts:

- The general PME Assistant Online Help.
- The help for the devices MP01, MP30, MP55, MP60 and MP70 of the PME family.
- This document on the MP85A.

1.1 The MP85A measuring system

The MP85A measuring system comprises the PME Assistant program and the PME MP85A or MP85A DP hardware. The MP85A DP is provided with a PROFIBUS interface in addition to the CAN bus and Ethernet interface. The mode of operation is however the same. The device parameters must be set either via the CAN bus or the Ethernet interface for both systems. If you have an older MP85, please use the PME Assistant provided for this device (up to Version 2.2).

The MP85A can be used for two different monitoring operations:

1. Monitoring a process with verification of a certain process curve using tolerance windows.
The measured values are checked at different points by the MP85A to see whether the sequence lies within a certain *range (tolerance window)*.
2. Monitoring a process for adherence to a *tolerance band or envelope curve*.

Starting with firmware version 2.22 the limit value results can be included into the OK/NOK evaluation with all monitoring methods.

There is also Version MP85A-S for switch and haptic test with tolerance windows. However tolerance band monitoring is not possible with these devices.

You can find more information about MP85A, e.g. measurement sequence, the data reduction function or the relation between the filters used and sample rate, in section [FAQ: MP85A and PME Assistant](#).

1.2 What needs to be done?

The following steps must be performed in order to prepare the MP85A measuring system for a measurement. The steps can be divided into two sections.

1. [Setting up the hardware](#): connect transducer (sensor), set up bus system or interface, connect power supply etc.



This part of the setup is described in detail in the MP85A Operating Manual. This online Help comprises only a summary.

2. Setting up the device via PME Assistant software.
Set up the device using this software and a PC which is connected to the MP85A via CAN bus or Ethernet interface as described in this Help.

Procedure

1. Start the PME Assistant, see also PME Assistant Online Help: Start options.

2. Connect to the MP85A, see [How do I connect the PME Assistant to the MP85A?](#).
3. Define the MP85A system settings: Select the [language](#), set the [synchronization](#) if using more than one device and, if required, set the [passcode](#).
4. [Setup of the measuring chain \(MP85A and transducer\)](#).
5. Determine and enter the start and evaluation criteria for the process: depending on the evaluation mode either for [Tolerance windows](#) or [Tolerance band](#). See also [EASYteach](#) for envelope curves.
6. [Specify the necessary outputs \(process results\)](#).
7. [Save all parameters](#).



The structure of the MP85A settings tree in the left-hand side of the program window corresponds to the sequence in which you should carry out the settings.



If these steps have already been performed, the data can be loaded from a file into the device, see [SAVE/LOAD PARAMETERS](#).



See also [The MP85A measuring system](#)

1.3 Setting up the hardware

This section is described in detail in the MP85A Operating Manual. To summarize:

- Connect the transducers.
- Connect the power supply.

- Connect the bus system and set parameters (addresses and transmission speed, etc.) if necessary. Because some of these settings are important for the program function, you will also find the most important settings described in [Configuring the MP85A interface\(s\)](#).
- Check the (hardware) synchronization if several devices are involved.
- Install the software on the PC, see also PME Assistant Online Help: Operating requirements and PME Assistant Online Help: Installation of software PME Assistant.



The first channel is always displayed as the x channel (horizontal axis) and the second as the y channel (vertical axis) in the graphs. Please connect the transducers suitably so that a correct display of $y(x)$ is achieved.

1.4 Firmware update

You update the firmware using the program PME-Update. With the program a new firmware version can also be transferred to several devices simultaneously.





With the MP85A process controller, in order to avoid interfering with the running of a process (no measurement or evaluation is carried out during an update), from firmware version 2.22 you can specify that the firmware is updated only after manual confirmation on the device (***F-update: allowed!***). If confirmation does not occur within 15 minutes, then no change to the firmware is made. Refer also to [General settings \(basic settings\)](#).

The device settings are also retained when updating the firmware. However, we recommend a backup is carried out before the update; refer to [Store settings and system parameters saved on the PC \(backup\)](#).

2 SYSTEM settings

2.1 General settings

 For passcodes see the separate section [Using the pass-code](#).

 The general settings are identical for all parameter sets. Some details in the **SYSTEM** → **General settings** section are for information only, e.g. hardware revision or device serial number. Besides that, you can carry out the following settings:

Language

Next to *Sprache* (or *Language* or *Langue*), if English is not set, select the desired language. Normally, the language version of the PME Assistant determines the language of the MP85A, i.e. when you start the German version of the Assistant, all menus and texts are also in German.

 After choosing a different language, all the windows are refreshed and formed anew. The language of the main menu (at the top in the window) as well as of the messages output by the program are however dependent on the language version of the program, PME Assistant, and are not changed.

Device name

Use the device name to improve the identification of a device in a group of several PMEs.

The device name does not affect the operation of the device.



In the menu **Data storage** the option **Keep device name on parameter change** specifies that when loading a parameter set the device name is retained, i.e. it is not overwritten by the name saved in the parameter set.

Date/time

The date and time are only used for [saving the results](#). The displayed time corresponds to that at the last window update, e.g. on calling the dialog. Therefore an exclamation point is displayed behind the time. The entered time is sent to the PME, when, after making a change, you quit the entry field by either clicking another field or pressing .

Hardware synchronization

You have to carry out this setting if you are using more than one device. In this case you set *one device* as the **Master** and *all others* as **Slave**. This prevents the carrier frequency measuring amplifiers of the individual devices interfering with one another over transducer cables that run parallel. However, *only the measuring amplifiers* are synchronized, not, say, the CAN bus interfaces or similar functions. You will find further information on this topic in the MP85A operating manual.

Firmware update only possible after release on the device

Here you define whether a firmware update may always take place or only when it has been confirmed on the device itself. This means that you can inhibit a firmware

update from starting via the network for all devices, e.g. in a running process (during an update no measurement or evaluation occurs). The update is then only executed after manual confirmation on the device (***F-Update: Permitted!***). If the confirmation does not occur within 15 minutes, then no change to the firmware is made.

2.2 Using passcodes

A passcode can be set, thus allowing you to block unauthorized access. This is a *number*. Letters are not allowed therefore we use the word passcode, not password.

If you have forgotten your passcode, use the master passcode **1702**, to reset the system and to allow you to enter a new passcode.



Menu commands and dialogs can be permanently blocked from the [EASYsetup](#) (FASTpress Suite) program module. If you do not have one of the entries listed in this Help, then the MP85A has been configured specially for you.

Prepare passcode usage (activate)

The passcode must first be defined under **SYSTEM** → **General settings** and the field **Specify passcode**. Turn on the function with **Activate passcode?** → **Yes**. Whenever you then start the PME Assistant program, you will only be able to access the menu command **SYSTEM** → **Passcode entry** and the **MEASURE + VISUALIZE** menu items.



Use **SYSTEM** → **General settings** and **Reactivate passcode** to hide all passcode protected menu items and dialogs. If those menus shall be accessed again, a new passcode entry has to be made.

Passcode entry

If the MP85A is protected by a passcode, you can only access this menu item and menu **MEASURE + VISUALIZE**. The correct passcode must be entered before you can access all other menus. If still some menus are missing, your MP85A is customized with program module Assistant configuration.

2.3 Interface parameters

The dialog displays the parameters for the interfaces installed, e.g. also the MAC address of the Ethernet interface. Most settings can only be changed on the device itself, see [Configuring the MP85A interface\(s\)](#).

With CAN bus the output rate (in multiples of 0.1 ms) and the format for PDO messages (cyclic PDOs) can be set in the dialog. The cyclic PDOs must however be started with an interface command.

With an MP85ADP (with PROFIBUS option) you can set the PROFIBUS address.

When using Ethernet you may also specify here a gateway address. Use **IPGateway1** to **IPGateway4** to type in the four parts of the gateway IP address. Gateways are used, for example, to be able to reach other IP segments or to send data via other protocols (network types).

-  See also Options, [Display connection loss detection](#). You can find the interface commands in the MP85A Operating Manual “Interface Description CAN/Pro-fibus/Ethernet”.

Configuring the MP85A interface(s)

Ethernet interface

Parameterization can only be carried out *manually*; in the PME Assistant the parameters for the interface are only displayed. The PME Assistant software must not be connected to the MP85A over this interface during configuration.

On the MP85A enter the Ethernet address (IP address) and the subnet mask. Operation with dynamic addresses (DHCP) is not possible. You should clarify with your network administrator which IP address (Ethernet address) and subnet mask you have to set. If you only want to establish a direct link between a PC and the MP85A, you can use any address, e.g. 192.168.169.xxx. The last group of three figures (xxx) must be a number between 1 and 254 and different for the PC and the MP85A. Make sure in this case that your PC can switch over the Ethernet connection to a direct link or use a "crossover cable" (not a normal Ethernet cable).

Setting the address and subnet mask on the MP85A:

1. Press the **SET** key for *at least two seconds*.
The display **CAN BUS** appears.
2. Press the **+** key until **ETHERNET** appears in the display.

3. Press the **SET** key.
The MAC address is displayed.
4. Press the **+** key so that the first group of the IP address appears.
5. Press **SET** to be able to change the value with **+** or **-**. Otherwise press **+** to proceed to the next group.
6. If you have changed a number, press the **SET** key.
7. After the display of the IP address you come to the display of the subnet mask. Change this according to your requirements.
8. To save the changes press the **SET** key for at least two seconds.
The flashing display **Save?** appears.
9. Confirm it by pressing **SET**.
In the second line a flashing double arrow and the text **Yes** appear.
10. Confirm this query also by pressing **SET**.

CAN bus interface

You can only change most parameters *manually*; the PME Assistant software must not be connected to the MP85A over this interface during configuration. Terminate the program if necessary.



You do not need to terminate or close the online help when you terminate the PME Assistant software.

Setting the baud rate on the MP85A

1. Press the **SET** key for *at least two seconds*.
The display **CAN BUS** appears.

2. Press the **SET** key again.
The **baud rate** display appears together with the currently set value.
3. Press the **SET** key once again.
A flashing double arrow appears on the left in front of the display of the current baud rate.
4. Press the **+** or **-** keys to change the value.
5. When the desired figure appears in the display, press the **SET** key.
6. Now press the **SET** key for at least two seconds.
The flashing **Save?** display appears.
7. Confirm it by pressing **SET**.
In the second line a flashing double arrow and the text **Yes** appear.
8. Confirm this query also by pressing **SET**.

PROFIBUS interface (only with MP85ADP)

In the PME Assistant only the PROFIBUS address can be set. All other PROFIBUS system parameterization is carried out via appropriate software from other manufacturers, e.g. PROFIBUS software from Siemens.

3 Prepare MP85A for your application

☞ All parameters can also be loaded from a file into the MP85A with **SAVE/LOAD PARAMETERS** → **Load from PC**.

Before you can start a measurement, you must enter, measure or read out the relevant transducer data from TEDS. Then define the criteria for the process monitoring and define the values to be output or saved ([Tolerance window settings](#) or [Tolerance band settings](#)).

 See also [LOAD PARAMETERS](#), [Hardware synchronization](#), [Display current values](#)

3.1 Setup of the measuring chain (MP85A and transducer)

Transducers with TEDS

For transducers with TEDS it is usually sufficient if you go to **PREPARE MEASUREMENT** → **Amplifier** → **TEDS** and activate the options **Find and use TEDS on device restart** and **Find and use TEDS during operation of device**. After restarting the MP85A (switch power supply off and on again), a search will be made for transducers with TEDS. They will be activated if found. If you cannot restart or if no full bridge, half bridge or LVDT transducer is connected, click on **Find and use TEDS**, see also [Using TEDS](#).

Transducers without TEDS

If you do not have a TEDS transducer, carry out the following steps to set up and adjust the measuring chain:

1. Enter type of transducers (sensors) used.
2. Enter measuring range, unit and required number of places after the decimal point.
3. Calibrate and adjust the measuring chain.
4. Enter other measuring parameters, e.g. low pass filter.
5. Check that the measuring chain is functioning correctly.

Different menus are used for these tasks. The easiest way is to go through these one at a time and make the relevant adjustments. Two different procedures may be used to adjust the measuring chain (step 3). These can be accessed from the **Enter characteristic** or **Measure characteristic** menus. The two procedures together with their advantages and disadvantages are described in [Adjusting the measuring chain](#).



No process (no measurement) is started as long as a transducer error is present and the MP85A is not capable of measuring.



You can find more information about MP85A, e.g. working speed, the data reduction function or the relation between the filter used and sample rate in section [FAQ: MP85A and PME Assistant](#).



See also [LOAD PARAMETERS](#), [Display current values](#), [FAQ: Meaning of the LEDs on the MP85A](#)

3.1.1 Specifying a transducer



If you have activated the options ***Find and use TEDS when restarting devices*** or ***Find and use TEDS in running operation*** in *one* channel using **PREPARE MEASUREMENT → Amplifier → TEDS**, you *cannot* then manually select the transducer type in any of the channels. If required, deactivate these options to be able to make a selection and then activate them again.

Depending on the type of transducer, you must provide details in the **Transducer** dialog for the general amplifier settings in the MP85A.



Label the channels using *names*. They are *shown in all other dialogs* and simplify assignment.



The channel names must *not* include the special characters *<*, *>*, */* or **.



In this dialog only the basic values for the (maximum possible) measurement range are set. The details for the actual scaling, i.e. the assignment between the actual reading and the displayed physical quantity is set via the scaling; refer to [Set characteristic curve](#) or [Measure characteristic](#).

The required data can be found on the data sheets for the relevant transducers. Some examples of the possible selections are listed in the following.

Full bridge

Strain-gauge transducers for force, pressure or weight are **full bridges** and require a measuring range of at least 2 mV/V: setting **4 mV/V**. Instead of strain-gauge transducers, piezoresistive transducers are also used for larger measuring ranges. In cases of doubt check the details in the transducer data sheet.

Half bridge

Inductive displacement transducers are typical transducers in the half-bridge configuration. Usually, they require a measuring range of 80 mV/V at a supply voltage of 2.5 V: setting **100 mV/V**. Newer displacement transducers can also be operated in a full-bridge circuit; in this case choose this setting, because better interference suppression is obtained. Inductive transducers can however also operate according to the LVDT principle (**L**inear **V**ariable **D**ifferential **T**ransformer); here it is essential to use the **LVDT** setting for this **transducer type**. Usually, you need a measuring range of 1 V/V for LVDT transducers. We recommend that the [characteristic is measured](#) for this type of transducer.

Potentiometer

Potentiometer types of transducer are often used for the measurement quantities of displacement and angle. A measuring range of 1 V/V is set automatically for these transducers (**fix**); internally, the MP85A uses the same circuit as for half bridges.

We recommend that the [characteristic is measured](#) for this type of transducer.

LVDT

The LVDT principle (**L**inear **V**ariable **D**ifferential **T**ransformer) is often used for inductive displacement transducers where the measuring ranges are 500 mV/V up to **1 V/V**. However, displacement transducers with a **half bridge** and output signals below 100 mV/V are also common, so check the details in the data sheet.

10 V

You can, for example, also connect active transducers via this input. The measuring range is permanently set to 10 V (**fix**).

Pulse generator

Pulse generators (pulse counters) or incremental transducers are transducers which facilitate the acquisition of, for example, a rotational speed via a digital signal. If two digital signals are available, you can also measure, e.g. rotational speed and rotational direction. If the transducer has an output for the zero index (z channel, home position), then you can also calculate the rotated angle. Since *all* edges are evaluated with this transducer type, a correct conversion must follow using the subsequently defined scaling (refer to [Set characteristic curve](#)). Activate or deactivate the **rotational direction** and **zero index** depending on the transducer and connection you are using.



The measurement of frequency is not possible.

SSI generator

For transducers with the *SSI interface* (**S**ynchronous **S**erial Interface) you have to set the coding used (standard: Gray code), the resolution used and the transfer speed. Multi-turn shaft encoders (many revolutions can be measured) usually use 24 or 25 bits to code the position, whereas single-turn transducers normally use only 12 or 13 bits. The transfer speed mainly depends on the length of the cable to the transducer. The maximum baud rate of 1000 kbaud can only be used up to a total length of 200 m. Please check the admissible values for your transducer (see transducer data sheet).

With transducers with the SSI interface the measurement is always read out 1200 times per second by the MP85A in response to an acceptance signal sent to the transducers.

Time

Instead of a transducer you can also define *time* as a **transducer type** (y(t) plots). In this case only *one channel is monitored over time* and used for the evaluation.

For the **Decimal point** you can specify the number of *displayed* decimal places, but the resolution of the measurements is not affected by this.



The number of decimal places set here is also used for the output in INTEGER format via the interface.

You define the physical unit via **Unit**. If you are using a TEDS transducer, you can define via **PREPARE MEASUREMENT** → **Amplifier** → **TEDS** that this unit and not the unit included in the TEDS is to be used. However, the unit must in this case be convertible, otherwise you

receive the TEDS error "Unit conversion not possible." Therefore, you can, for example, convert Pa (pascal) into bar or psi, but not N (newton) into mm (millimeter).



For active transducers, incremental transducers or transducers with the SSI interface the supply can be provided via the MP85A (5 V) or an external power supply unit (10 ... 30 V). The setting is made using a switch in the device; further information on this can be found in the MP85A operating manual.

3.1.2 Adjusting the measuring chain



If you have activated the options ***Find and use TEDS on device restart*** or ***Find and use TEDS during operation of device*** for *one* channel using **PREPARE MEASUREMENT → Amplifier → TEDS**, you can no longer measure the characteristic for *any* channel. If necessary, deactivate these options to be able to carry out an adjustment and then reactivate them.

If you are carrying out these settings for the first time, please see the information given in section [Introduction and comparison of the procedures](#). Experienced users can go straight to one of the two procedures.



See also [Status information](#) and [FAQ: Possible error messages and instructions for correction](#)

3.1.2.1 Introduction and comparison of the procedures

Transducers with linear characteristic must be used for all procedures, i.e. transducers where the input quantity (physical), e.g. force, and the output quantity (electrical), e.g. mV/V, show a linear connection. In other words: for linear force sensors, the outgoing signal is twice as high when the force is double. Non-linear transducers are, for example, thermo-elements. Here, the outgoing signal is not twice as high when the temperature is double. As soon as a linear behavior is true (as is the case for most transducers), the adjustment is simplified to the definition of a straight line, the characteristic (curve) of the sensor. The values required are called the transducer *characteristic* and must be entered so that the measured physical force, displacement, angle quantities, etc. can be displayed correctly. The characteristic can be established either from a calibration protocol or data sheet (nominal values) or determined from a measurement.

The measured value can only be displayed in physical units with the help of this assignment “which display should appear for which measured value”. Three procedures can be used to determine this assignment:

1. Using a transducer with TEDS module

The data from the transducer calibration is saved in the TEDS module.

Advantage: You only need to activate the corresponding options in the TEDS menu, the other settings will be carried out automatically; incorrect settings are excluded.

Disadvantage: Errors caused by improper installation of the transducer are not recognized. For example, a

transducer that is mounted at an angle to the load input direction will only measure a part of the force exhibited. This error can only be recognized by calibrating with direct load.

2. **Entry of the characteristic or nominal values (sensitivity and range)**

Advantage: fairly simple to perform.

Disadvantage: The procedure cannot be used for all transducers. For example, it cannot be used for inductive transducers. Faults caused by improper installation of the transducers are not recognized: A transducer which is mounted at an angle to the load input direction will only measure a part of the force exhibited. This fault can only be recognized through a measurement with direct load.

If the values are only taken from a general data sheet, there may be larger differences depending on the type of transducer. This is shown in the data sheets as *sensitivity tolerance* or *allowed sensitivity deviation*. It is therefore preferable to enter the actual sensitivity from the calibration protocol of the transducer.

3. **Measuring the characteristic with real load or displacement, etc., i.e., comparison by measuring two points in the range to be measured**

Advantage: Faults caused by incorrect installation of the sensor are recognized, the entire measuring chain is checked with this measurement.

Disadvantage: This procedure is time-consuming; the *calibration standards* for an *exact* measurement are generally expensive and not always procured easily.

You must select one of these operations depending on the type of transducer to ensure the required measurement uncertainty.



Inductive transducers should always be measured as complete measuring chains, i.e. with the cable and channel which will be used for the measurement, to ensure as few measuring errors as possible.

3.1.2.2 Using TEDS

For transducers with TEDS it is usually sufficient if you activate the options ***Find and use TEDS on device restart*** and ***Find and use TEDS during operation of device***. After restarting the MP85A (switch power off and on again), a search will be made for transducers with TEDS. They will be activated if found. If you cannot restart or if no full bridge, half bridge or LVDT transducer is connected, you must click on ***Find and use TEDS***.



If you have activated the options ***Find and use TEDS on device restart*** or ***Find and use TEDS during operation of device*** for *one* channel, you can no longer change the settings for *any* channel via the **Transducer** or **Enter characteristic** menus and the **Measure characteristic** menu is not accessible. Deactivate these options at least temporarily in order to be able to use these dialog windows and adjust the settings for a channel without TEDS.

In order to display another unit than the one saved in the TEDS module, you can activate the option ***Convert TEDS unit into current unit***. In this case, it must be possible to convert the unit; otherwise the TEDS error “unit conver-

sion not possible” will be issued. You can, e.g. convert Pa (Pascal) into bar or psi, but not N (Newton) in mm (Millimeter). First read out the TEDS module, then go to **PREPARE MEASUREMENT** → **Amplifier** → **Transducer** and define the required unit. As last step activate your TEDS options. Otherwise the unit used will be changed to that in the TEDS and can then no longer be changed.



Carry out a zero balance if you have changed the unit or the conversion.



indicates that a TEDS module has been recognized in the channel.



indicates that all TEDS settings that could be carried out by the MP85A have been activated. (For example the template “Calibration table” is not supported as the MP85A can only make linear scaling.)



indicates that not all settings could be activated. You will receive further information about the error in the **TEDS error** frame.



indicates that no TEDS module has been found.



To save the **TEDS** dialog settings permanently, you must use [SAVE/LOAD PARAMETERS](#) → **Save to Flash**. The settings can be different for each parameter set.

3.1.2.3 Entering the Transducer Characteristic



If you have activated the options **Find and use TEDS when restarting devices** or **Find and use TEDS in running operation** in *one* channel using **PREPARE MEA-**

SUREMENT → **Amplifier** → **TEDS**, you *cannot* then set the characteristic curve in any of the channels and can only display the set values. If required, deactivate these options to be able to make entries and then activate them again.

Two points are always needed for setting the characteristic curve, but they need not necessarily be the zero-point and full scale reading. To keep the measurement deviations (errors) as small as possible the points applied should however lie at the limits of the range of the relevant physical quantity later used. For example, if you load a force transducer with forces between 10% and 50% of the nominal load, you can also use these values.



The electrical values of the characteristic curve must lie within the selected measuring range. With a 4 mV/V measurement range you must not enter 5 mV/V for xx kN.

The *transducer sensitivity* stated in the calibration certificate corresponds to the *span (difference)* in the output signal between the two points "Transducer unloaded" and "Transducer with nominal load". Therefore, when entering the sensitivity as the second point, normally you enter zero for the first point.



The deviation of the zero value from the zero-point in the current installation situation can be corrected later via the [zero balance](#).



With inductive transducers you should *always* [measure the characteristic](#).

-  The scaling can extend from 1/30 of the measuring range for 1,000,000 digits resolution to 10 digits resolution for the whole measuring range. With usage as a counter or with SSI transducers the scaling can be between 20 digits for one pulse (1:20) and 10,000 pulses per displayed digit (10,000:1).

Relationship between input signal, characteristic curve and display

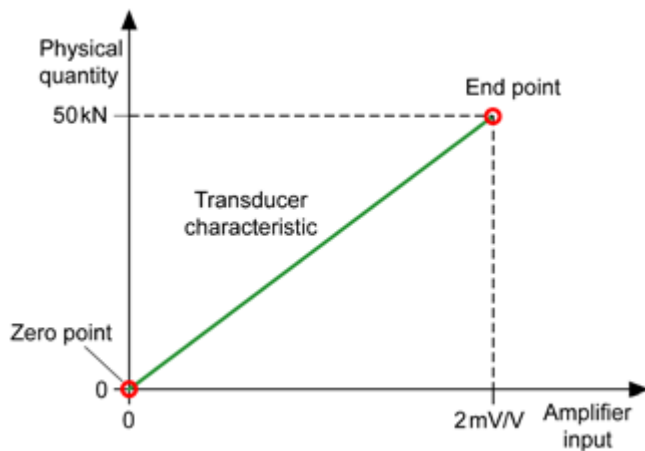

In this graph force is used as the physical quantity, but displacement or pressure could be used similarly instead. The illustration may have been produced, for example, during the measurement of the sensitivity values on the calibration certificate in a testing machine. (The zero value of the transducer after installation in the testing machine is also adjusted to zero here *before* the measurement.)

Enter characteristic curve: Example 1

Force transducer with sensitivity 2.00147 mV/V (calibration certificate) at 50 kN nominal load	
Transducer: <i>Measuring range</i>	4 mV/V
Zero-point electrical	0
Zero-point physical	0
Sensitivity electrical	2.00147
Nominal value physical	50



After these entries call the [Signal conditioning](#) dialog and adjust the zero-point.

Enter characteristic curve: Example 2

Transducer with 5 V output voltage at 20 bar pressure (relative pressure transducer)	
Transducer: <i>Measuring range</i>	fix (10 V)
Zero-point electrical	0
Zero-point physical	0
Sensitivity electrical	5
Nominal value physical	20



After these entries call the [Signal conditioning](#) dialog and adjust the zero-point.

Enter characteristic curve: Example 3

Potentiometric transducer with 150 mm nominal measuring displacement	
Transducer: <i>Measuring range</i>	fix (1 V/V)
Zero-point electrical	-500 mV/V
Zero-point physical	0
Sensitivity electrical	1000 mV/V
Nominal value physical	150



We recommend that the [characteristic is measured](#) for this transducer type.

Enter characteristic curve: Example 4

Rotary encoder (rotated angle) with 720 pulses per revolution (360°) on two channels	
Zero-point electrical	0
Zero-point physical	0
Sensitivity electrical	2880 (see note)
Nominal value physical	360



Since all edges are counted, four times the counting pulses is obtained.

3.1.2.4 Measure transducer characteristic



If you have activated the options **Find and use TEDS on device restart** or **Find and use TEDS during operation of device** for *one* channel using **PREPARE MEASUREMENT → Amplifier → TEDS**, you can no longer measure the characteristic for *any* channel; the menu cannot be accessed. If necessary, deactivate these options to allow you to carry out the adjustment and then reactivate them.

Two points are always required to measure a transducer characteristic. However these need not be zero point and end value (full scale or range). To keep the measurement differences (errors) as small as possible, the points should lie on the limits of the range used of the respective physical quantity. If, for example, you use a force transducer only between 10% and 50% of the nominal load, these values can also be measured. Usual values are zero point and 80% of the measurement range used.



The measured values should not lie too close together. Example: If the measurement is done using 0% and 5% of the measuring range, a difference of 0.1% in the second measurement point (5%) will lead to an error of 2% at full scale reading (measuring range).



The electrical values of the transducer characteristic must lie within the selected measuring range. With 4 mV/V measuring range (SG transducers), a measured value of e.g. 80 mV/V (inductive transducers) leads to overloading, **Transducer error** is then shown in the **Display current values** window.

Procedure

1. Go to the first point on the characteristic curve, e.g. move the displacement transducer to the starting position. With force and zero as selected point on the characteristic: unload (release) the transducer.
2. Enter the corresponding physical value under **1st point physical**, e.g. **0**.
3. Click on **Measure 1st point**. The value measured by the MP85A appears under **1st point electrical**.
4. Go to the second point on the characteristic curve, e.g. set displacement with end gauges, set force value with a weight set or use a reference transducer, etc.
5. Enter the size set under **2nd point physical**, e.g. **40 kN** or **60 mm**.
6. Click on **Measure 2nd point**. The value measured by the MP85A appears under **2nd point electrical**.



Use **Shunt: On** to activate the shunt built into the MP85A. This resistor (87,1 k Ω) is switched in parallel to bridge arm 2 and results in a signal of *approximately* +1 mV/V with a 350 Ω transducer. You can use the signal as *control signal*, because it should always produce the *same* reading, after the system has been calibrated. However, it is not possible to use this signal for calibration purposes because the exact reading cannot be calculated.

Note for inductive displacement transducers

When using inductive transducers *with measuring range in positive and negative directions*, ensure that the process range lies within the specified measuring range (usable displacement range) for the transducer. This is

always specified symmetric to the mechanical zero point of the transducer and therefore must be determined first:

1. Set the **Zero value** to 0 (enter **0** and press ) in the **Signal conditioning** dialog.
2. Call the **Display current values** window via **MEASURE + VISUALIZE**.
3. Move the transducer core until the output signal displays zero again.

This mechanical zero point is however unimportant for measuring the characteristic curve. The zero point for the display can be set at any position on the measuring range.

3.1.3 Signal conditioning (zero balance, low-pass filter)

In this dialog window the zero signal of the transducer in the existing installation is determined and eliminated for further measurements (set to zero).

See also Timing diagram of a zero balance.

Procedure for zero balancing

1. Unload the transducer, i.e. move the system into the “zero position”.
2. Click on **Zero balance**.



The measured electric signal is converted to the physical unit via the entered or measured [characteristic](#).

If the measured zero value of *both* channels should apply for all parameter sets, i.e. it should not be changed when the parameter set is changed, select **Do not overwrite** for

Overwrite zero value on change of parameter set. The setting always applies to both channels and independent setting is not possible.

When a value is entered in the **Zero reference**, this is then always displayed if the value shown under **Zero value** is measured. The function can be used, for example, to display a displacement measurement in the range 100 mm to 150 mm correctly, although only one 50 mm displacement transducer is used. Measure the zero value (**Zero balance**) in the position 100 mm and enter **100** as **Zero reference**. This value is then added to all following measurements.

Low-pass filter

The signals can be filtered to improve the quality of the signal: **Low-pass filter**. Here you can activate a low-pass filter (several different limit frequencies are available) to cut off noise which disturbs the signal. However the setting affects the maximum possible sample rate, see Sample rate and filter settings.



The limit frequency set must lie far enough *above* the maximum signal frequency so that the process measurement is not influenced. In case of doubt, perform the measurements using different filter frequencies and compare the results. For instance, check that fast signal changes are registered correctly.

Notes

- Low pass filters are filters of the fourth degree with Bessel characteristic, and have a relatively wide transmission range between pass-through and stop

band. More data can be found in the Operating Manual of the MP85A.

- To exclude run-time differences caused by different filter frequencies, only the *same filter frequency* can be used for *both channels*, the other channel will be automatically changed.

3.2 What needs to be considered when zero balancing and how long does it take?

With low filter cut-off frequencies the filter settling time must be allowed to pass *before* the zero balance. A pulse of at least 5 ms duration is required on the digital input for the zero balance. The zero balance terminates a further 5 ms later.

Refer also to [Signal conditioning \(zero balance\)](#).

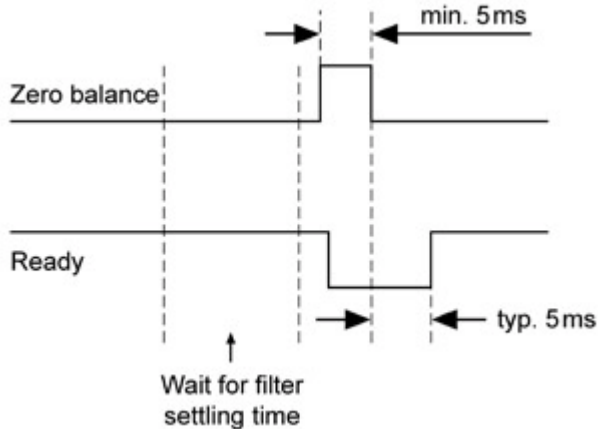

☞ Only level *changes*, i.e. *edges*, are evaluated on the digital inputs.

3.3 How are the sample rate and filter settings connected?

Depending on the filter used, a certain (internal) sample rate is used initially, see table.

Low-pass filter	Internal sample rate (in samples per second)
0.05 Hz	1.15
0.1 Hz	2.3
0.2 Hz	4.6
0.5 Hz	17
1 Hz	37.5
2 Hz	75
5 Hz	150
10 Hz	300
20 Hz	600
50 Hz	1200
≥ 100 Hz	2400



SSI transducers are always recorded at a rate of 1200 values per second

3.3.1 Transducer test

This test is normally used to go to a reference point (measuring point) on the characteristic curve and then check whether this point is correctly reached. Activate the check

itself, i.e. the measurement and calculation either by a command via the interface or by a digital input. You can read out the status information ***Transducer test result...*** via the interface or as a digital output.



Make sure that the correct measuring point (e.g. force transducer unloaded) is used at the time of the test.

Enter the measurement value *expected* under ***Reference value*** and define the maximum difference under ***Deviation***. Both entries are given in the unit of the channel, e.g. in kN.



Do not confuse the transducer test with the transducer error check that is always carried out, e.g. during the measurement and is displayed in the status.

See also *Measuring value status* and *Error messages* with the [Display current values \(measurement display\)](#).



With force transducers the zero value can be checked here. If the difference is too large, this could indicate an overload of the transducer in the process. With displacement transducers the starting point could be checked, i.e. whether the reference points of the machine have changed.



See also [Additional functions](#), [Digital inputs](#) and [Digital outputs](#)

3.3.2 What is the procedure for a transducer test and what needs to be considered?

With low filter cut-off frequencies the filter settling time must be allowed to pass *before* the test. A pulse of at least 5 ms duration is required on the digital input for the transducer test. The result is obtained typically a further 10 ms later.

Refer also to [Transducer test](#) for the functioning principle.

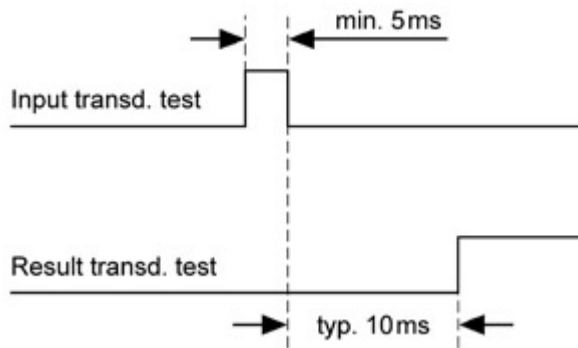

☞ Only level *changes*, i.e. *edges*, are evaluated on the digital inputs.

3.4 Additional functions

3.4.1 Limit values

Limit values are typically used for the real-time monitoring of safety-relevant values. Up to four limit values can be monitored for each channel. The four limit values are defined and activated in separate dialogs. To set a digital

output when a limit value is triggered specify it in the [Digital outputs](#) menu.



Limit values can be defined, but nevertheless deactivated (**Monitoring: off**). In this case all the settings are retained.



Using **Graph** → **Graph settings** you can display the **Limit values as auxiliary lines in the graph**.

The function and settings of the limit switches are as commonly used. On reaching the limit value it is designated as active and in the [Signal reading](#) window LVx is marked with a red spot. After leaving the hysteresis band, the spot next to LVx is shown in gray again. Depending on the **switching direction**, the hysteresis band lies above or below the limit value.

Activating the limit signaling for Above limit:

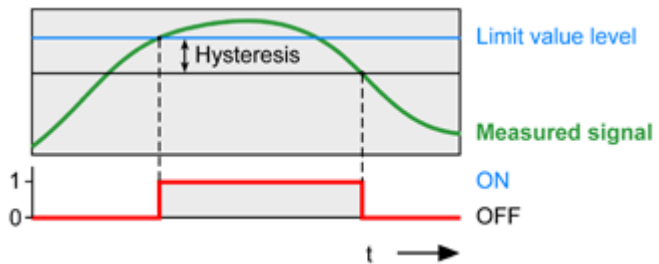

Activating the limit signaling for Below limit:

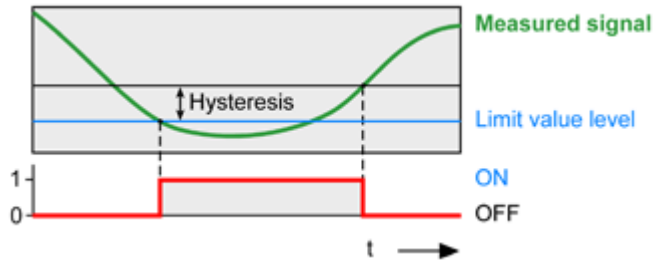

Considering the status in evaluation

The function **Consider status in evaluation** enables you to specify values which have to be exceeded or undercut in order that a process is assessed as OK. When activated, these *limit values* are taken into account in the *process evaluation* in addition to the specified *windows*, the *tolerance band* or the *envelope curve*, i.e. the process is only evaluated with OK when the limit condition has also been fulfilled (e.g. exceeded with **Switching direction: above**).

The limit results are also displayed in the window [Display of stored data](#).

3.4.2 Digital outputs



The status is also displayed in the window [Display current values](#).

With the digital outputs, certain system statuses can be transferred externally independent of the bus system. The messages **Process: Alarm**, **Process: OK**, **Process: Started**, **Process: Busy**, **Process: Result processed** and **Tolerance window x OK** or **Limit value x, channel a** are frequently used to output the current status.

You can also specify whether the **Switching logic** should be **Positive**. For *active* status, e.g. limit value exceeded, the output then has—depending on the power supply—e.g. 24 Volt. If the switching logic is **Negative**, this level is output when status is *inactive*. More information about levels and outputs loads can be found in the Operating Manual. You will find diagrams which show the measurement sequence and the corresponding digital levels in section [Timing diagrams for different Start/Stop/End conditions](#).



Different outputs are available depending on the MP85A type.

Possible settings

Setting	Description
Limit value, channel ...	The Limit value status of this channel is output.
Error, channel ...	There is a measuring error in the channel. This can be a transducer fault (e.g. in the connection), a fault in the A/D converter, the scaling, the amplifier calibration (factory calibration), TEDS error or a gross overflow.
Process: Alarm	An error occurred during the process or operation. See also Error messages for tolerance window violations
Process: OK	The process or operation was evaluated with OK. See also Error messages for tolerance window violations
Process: NOK	The process or operation was evaluated with NOK (not okay). See also Error messages for tolerance window violations

Setting	Description
Process: Started	The process or operation has been started. See also Timing diagrams for different Start/Stop/End conditions
Process: Running	The operation or process was started. See also Timing diagrams for different Start/Stop/End conditions
Process: Ready	The operation or process has been finished. See also Timing diagrams for different Start/Stop/End conditions
Process: Result processed	The operation or process has ended. The result is available and can be evaluated. See also Timing diagrams for different Start/Stop/End conditions
Heartbeat	The output changes between ON and OFF with a frequency of 1 Hz and can be used as a watchdog function.
MMC/SD Card memory full	The MultiMediaCard/SD Card is almost full, there are less than 5 megabytes free. Replace the card with a new one or delete the files. See also Replace MMC/SD Card
Internal memory full	The internal memory is almost full, there are less than 16 kilobytes free. The message points to a problem when storing measured data. One reason could be that the specified PC is not accessible due to a network problem. See also Timing diagrams for different Start/Stop/End conditions and Save data and results (data storage)
Tolerance window x OK	With this message, individual windows can be checked and evaluated

Setting	Description
Transducer test result channel ...	<p>Result of a transducer test, corresponds to the result of Run test under PREPARE MEASUREMENT → Amplifier → Transducer test.</p> <p>See also Transducer test</p>
Reset Piezosensor	<p>Allows you to set a channel using a piezo sensor to zero until the measuring starts. This allows the zero point drift of these sensors to be suppressed. The signal corresponds to the signal Process: Ready, i.e. the signal is triggered only after the measuring starts.</p> <p>See also Timing diagrams for different Start/Stop/End conditions</p> <p>If you use this option, you may not monitor a start condition for this channel at the same time: this channel is only measured after the measuring process starts.</p>
Data word bit ...	<p>The digital outputs can be set via via the SDO object 2320 (hex), subindex 0. With this function it is possible to pass on individual bits of the bytes transferred with this object to the corresponding outputs, see example below.</p>
Parameter-set number bit x	<p>This enables you to determine the number of a parameter set loaded from the flash memory: the parameter-set number is output as binary number with bit 0 to bit4. Parameter sets loaded from the MMC/ SD Card or PC cannot be interrogated.</p>
Loading parameter set	<p>Using the function you can check the time required for loading a parameter set: the next process can only start after the switchover, which can take up to 200 ms; the MP85A is only ready for measurement again after the switchover. Consequently, as long as the signal is active, no new process can be started.</p>



See also [FAQ: MP85A and PME Assistant](#)

Example: Set a digital output via software

To set Output 1 (Terminal 3, Out 1) via a software instruction (SDO) (switching logic positive), specify the value 1 in the index 2320 (hex), subindex 0. This sets Bit 0, corresponding to Output 1.

You can test the instruction, for example via the SDO terminal (send ... to device). With the SDO terminal you can also check the current status of the output by reading the same index and subindex (Read from device).

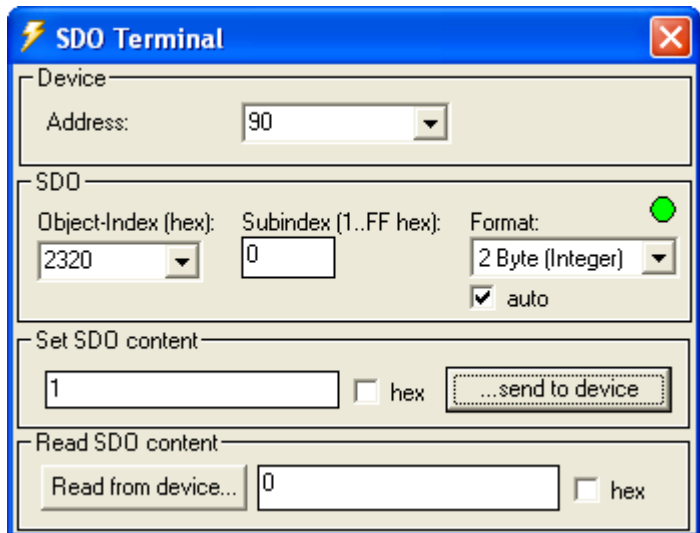

3.4.3 Digital inputs



The status is also displayed in the window [Display current values](#).



Only *changes* to the level on the inputs are evaluated, i.e. the *flanks*.

If you allocate more than one function to the same input, e.g. **Zero balance** and **Clear statistics** on **Input 1**, the functions will be handled in the following sequence: Zero balance—Shunt calibration—Load parameter set—Start/End process—Start transducer test—Clear statistics—Clear total statistics—Save statistics.



Different inputs are available depending on the MP85A type.

You may use up to four additional “software” digital inputs with the MP85ADP-S (version for switch and haptic testing), if the single digital input provided by the MP85ADP-S is not sufficient. Four input states may be transmitted via the interface which provides you with five digital inputs in total. However, keep in mind that the speed of a software input is not as fast as the speed of a hardware input. Therefore time delays may occur between these signals and the measured data depending on the bus system used.

Possible settings

Setting	Description
Zero balance	Corresponds to the zero adjustment under PREPARE MEASUREMENT → Amplifier → Signal conditioning . See also Signal conditioning
Shunt calibration	Corresponds to activation of the shunt resistance (Shunt: Enabled) under PREPARE MEASUREMENT → Measure characteristic . See also Measure transducer characteristic .
Load parameter set (from flash EPROM)	If, for example, only three different parameter sets are required, you can use only two inputs with Load parameter set bit 0* and bit 1* . It is not necessary to use all bits (parameter set 0 contains the factory settings). With the Signal conditioning you can define whether the zero value is retained during loading or whether the zero value from the parameter set is used. Use the Data storage menu to specify that the device name shall be retained (not overwritten with the name stored in the parameter set) when loading a parameter set.
Start/End process	This input can be used to start and end a process or a measurement. If you specify further Start, Stop or End conditions, these apply <i>additionally</i> . See also Timing diagram for a measurement with no data loss or Timing diagram for a process-optimized measurement and Control settings for tolerance windows or Control settings for tolerance band
Start transducer test	Corresponds to Run test under PREPARE MEASUREMENT → Amplifier → Transducer test . See also Transducer test
Clear statistics or clear total statistics	The statistics of the current or all parameter sets are deleted. The OK/NOK process counters are deleted too.

Setting	Description
Save statistics	Corresponds to Save <i>statistical data</i> under PREPARE MEASUREMENT → Data storage . See also Save statistical data
Switch test ¹⁾ 1 ... 5	With a switch test, specify which inputs will be used for the test. The inputs must be connected to a power supply via the switches to be tested so that their status will be recognized. You may use up to four virtual digital inputs with the MP85ADP-S as this device has only one digital input available. In this case the state has to be defined using a PROFIBUS command (cyclical transmission). See also Switch test The switching time points are also displayed in a haptic test if an input has been allocated. See also Haptic test

¹⁾ MP85A-S only, i.e. with switch test and haptic test option



See also [FAQ: MP85A and PME Assistant](#)

4 Settings for monitoring using tolerance windows

The definition of the evaluation criteria is a multi-stage process that cannot be carried out theoretically as several measurements are required. The measuring chain must therefore already have been completely adjusted, see [Setup of the measuring chain](#).

Go to **Specify evaluation mode** and enter **Window** as evaluation mode.



If you change the evaluation mode, you should delete the statistical data as they will not be relevant for the new mode and would lead to an incorrect result (see [3D graph](#)). You can also clear the process counter from the **Process** menu (**Configure evaluation parameter** window must be open). Resetting the process counter will however also affect the [File names](#). If necessary, save files already created, as the counter will start at 1 when reset.

We recommend that you proceed as described in section [Principal procedure](#) if you are adjusting these settings for the first time.

- [Principal procedure](#)
- [General information about the Configure evaluation parameters window](#)
- [Control settings](#)
- [Alarm window](#)
- [Range window](#)

- [Important information about tolerance windows](#)
- [Tolerance windows](#)



You may [Start the measurement sequence manually](#) to determine appropriate windows. Use **Graph** → **Curve history mode** to display up to five successive measured curves simultaneously, see also [Curve history mode](#).



See also [EASYteach](#) ()

4.1 Principle procedure



When you first use a new MP85A, the presetting (factory setting) for the alarm window and the range window corner points are identical, i.e. both windows are on top of each other. The presetting for the corner points is -10/-10 and +10/+10. The alarm window must be larger than all other windows.

Step 1

First go to the [Alarm window](#) tab and click on **Adjust alarm and range windows autom.** The alarm window will be set to the measuring range of the transducer enlarged by 15% in all directions; the range window will be set to the measuring range enlarged by 10%. The Δx and Δy of the data reduction will also be set to practice-oriented values for these ranges.

Step 2

Check the values on the **Alarm window** tab. All measured values must lie within this window. These are, e.g. maximum traverse path or maximum force, etc. as well as

the minimum values that could occur as long as the system is operated *correctly*.

Step 3

Check the [Range window](#) tab. The window covers the operating range that is relevant for the measurement, i.e. the range in which the “important” measured values lie. Thereby you can, e.g. distinguish between the starting path with a pressfit operation and the actual measurement, see figure.

Step 4

Make one or more typical [process measurements manually](#).

Step 5

Decide which ranges are relevant for the evaluation and which conditions must be fulfilled so that the process runs as required: [Tolerance windows](#).

Step 6

Set the Start, Stop and End conditions for the process on the [Control settings](#) tab. Check and, if necessary, correct the data reduction settings and the Alarm and Range window settings.





Abb. 1: Example of the application of a range window

4.2 The Configure evaluation parameter window

The first channel is always displayed as the x channel and the second as the y channel in the graph in the **Configure evaluation parameter** and **MEASURE + VISUALIZE** dialogs. The top x axis displays relative coordinates (see [x channel relative to](#)) if a reference point has been entered for one of the tolerance windows. However, relative coordinates can *only* be used for windows which are to be evaluated *after* the measurement has ended.

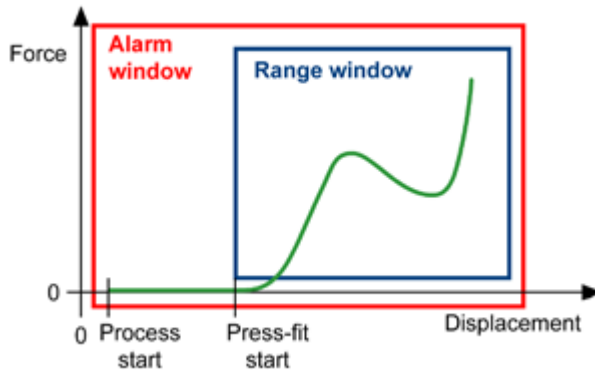
The process number and the number of the measuring points acquired (see [Control settings](#)) is shown on the right-hand side of the line at the top of the window (toolbar). The line immediately above the graph in the dialog window shows the device name (**General settings**), the active parameter set and the workpiece name (**Data storage**), if this was set.

Status messages comprise icons and text and are displayed in the bottom line of the dialog window:

 indicates a fault in the MP85A

 shows that a MultiMediaCard or SD Card has been inserted

 warns that *no* MMC/SD Card is inserted (appears only if **Save to MMC/SD Card** has been activated, see [Save data and results](#))

 is displayed while data or parameters are being saved

If you place the mouse pointer over one of these icons, explanatory text is displayed as a tool tip. Note the status line text messages, also in the main program window, for more explanations.

Graph scaling, zoom

 scales the graph so that the largest window or all curves will be displayed (Autoscale everything)

 scales the graph to fit into the range window (a margin of 10% will be used)

 opens a dialog for manual scaling in which you can also accept the scaling currently displayed

You can at any time zoom in and out within the graph: keep the left-hand mouse key pressed to mark the area you wish to zoom into and select **Zoom** from the context menu. **Ctrl**-Z returns to the last display; a maximum of

nine zoom steps are provided. Use  or go to **Graph** → **Reset zoom** to display the full area (alarm window).

Use **Graph** → **Graph settings** to display the **Curve with connected points** or superimpose a **Grid**.



See also [Curve history mode](#)

4.3 Control settings



First go to the **Alarm window** tab and click on **Adjust alarm and range windows autom.** to get suggested values. The alarm window will be set to the measuring range of the transducer enlarged by 15% in all directions; the range window will be set to the measuring range enlarged by 10%. The Δx and Δy of the data reduction will also be set to practice-oriented values for these ranges.

So that the amount of data is not increased unnecessarily, the number of values to be checked (and saved) is limited: **Data reduction**. You must therefore specify how high the resolution should be for the respective channel. As soon as the current measurement for *either* the x or y channel is larger than the old measurement plus the difference entered, a measured value triple is saved, i.e., the value for *both* channels plus the time value. A maximum of 4000 values are recorded for processing. The measuring is then stopped and a buffer overrun message is issued. The resolution selected can be seen on each curve after a measurement: the measuring points used for the evaluation are also displayed in the graph (**Graph** → **Graph settings** → **Curve with connected points**). After

the measurement, the number of actual measuring points acquired will be displayed on the right-hand side of the line at the top of the window (toolbar)..



Only saved values will be checked in the windows.



Make a [test measurement](#) and look at the values registered in the graph. If necessary, zoom (hold left-hand mouse key down and drag across the section) to see whether the resolution is sufficient or whether the data reduction values must be reduced.



See also [Data reduction](#), [FAQ: MP85A and PME Assistant](#), Sample rate and filter settings, [Digital inputs](#)

Use the **Control settings** tab to enter the relevant values on the **Start**, **Stop** and **End condition** tabs.

4.3.1 Maximum measuring time

With **Maximum meas. time**, an end criterion must be set. The measurement will end at the latest when this time has elapsed.



If you start a measurement manually, you must either stop it manually () , send an interface command or use the external signal to end the process before the evaluation starts.

The interface commands can be found in the MP85A Operating Manual under “Interface Description CAN/Profibus/Ethernet”.

As a rule, an **End condition** is used to end a process.

4.3.2 Start conditions

The following methods are available to you for starting a process:

1. By an **External start signal** ([start/end event](#))
2. By exceeding/undercutting certain values of a channel (internal start condition, **Start above (below) set point**).
3. Manually via .
4. By an interface command.

You will find the interface commands in the operating manual “Interface Description CAN/PRO-FIBUS/Ethernet” of the MP85A.



No process (no measurement) is started as long as a transducer error is present and the MP85A is not capable of measuring.

The process is also started when you have chosen starting via an external signal or internal condition and one of the two latter events occurs.



No start conditions are apparent with an MP85A with older firmware versions; refer to How do I carry out a firmware update and can the update be prevented?.

4.3.3 Stop conditions

You can stop a process as follows:

1. **Standstill recognition**

If the measured signal changes by less than the value entered during the time specified, the process is treated as finished and the evaluation will begin.

2. **Above/below reference value + time until stop**
(follow-up time)

One or both channels can be checked. Enter the reference value(s) which should be monitored and the time until stop, i.e. the amount of time the measurement should continue once this value has been reached.



The condition is only evaluated if—with **below reference**—the reference value plus hysteresis has been exceeded once or if—with **above reference**—the reference value minus hysteresis has been undercut once. The hysteresis (5% of the range window) is required to ensure that noises or small disturbances in the signal do not cancel the measuring at the time t_x . The percentage entry refers to the respective axis of the range window.

See Example Stop/End condition: below reference value in x channel and Example Stop/End condition: below reference value in y channel

3. **Stop at reverse motion of channel x**

The operation is stopped as soon as the measured value in the x channel is smaller than the Δx entered for the **Data reduction**.

4. External end signal (Stop condition **None**)

A digital input ([Start/End process](#)), for example from an end switch or the PLC, signals the end. This also stops the process.



Only level changes (flanks) are evaluated.

Notes about the Stop conditions

- In cases 1 to 3, the process will also stop (and finish) if you have selected **External start signal** and the level of this signal has again changed (event “End”), if



you click on  or if the corresponding interface command is issued.

You can find the interface commands in the MP85A Operating Manual “Interface Description CAN/Pro-fibus/Ethernet”.

- All Stop conditions are immediately evaluated using the (raw) data. They are not evaluated using the values shown in the graphs which have resulted from the data reduction. A graph may display values at different points in time than those actually used for evaluating a Stop condition.
- If both channels are to be checked, for example, for **Below reference value**, the condition is considered as fulfilled if the signal drops below the set point on one channel while the other lies statically below the reference value. It is not necessary to have a level *change* for the second channel. This also applies when using **Above reference value**: as soon as the condition is met for the first channel, the *level* of the second channel is evaluated. The condition is considered fulfilled if the level is already higher than the specified reference value.

For the *Below limit* condition the hysteresis lies *above* the reference value.



Abb. 2: Example of stop/end condition: Undercutting reference value on x channel

For the *Below limit* condition the hysteresis lies *above* the reference value.

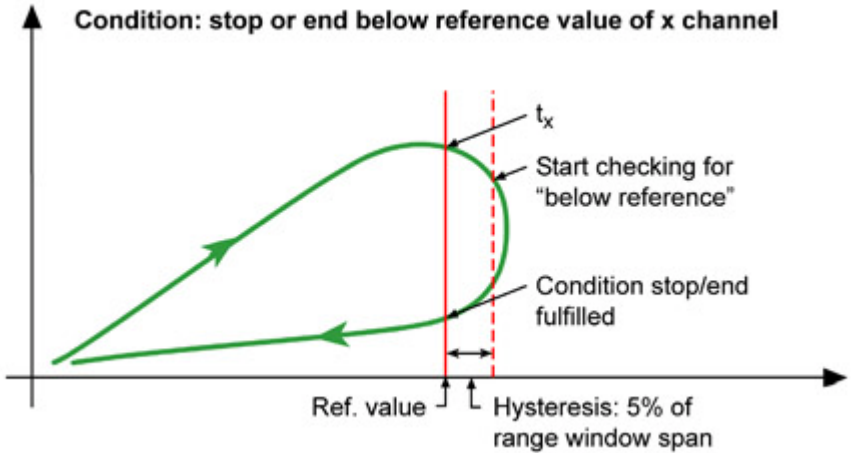

Abb. 3: Example of stop/end condition: undercutting a y channel reference value

4.3.4 End conditions

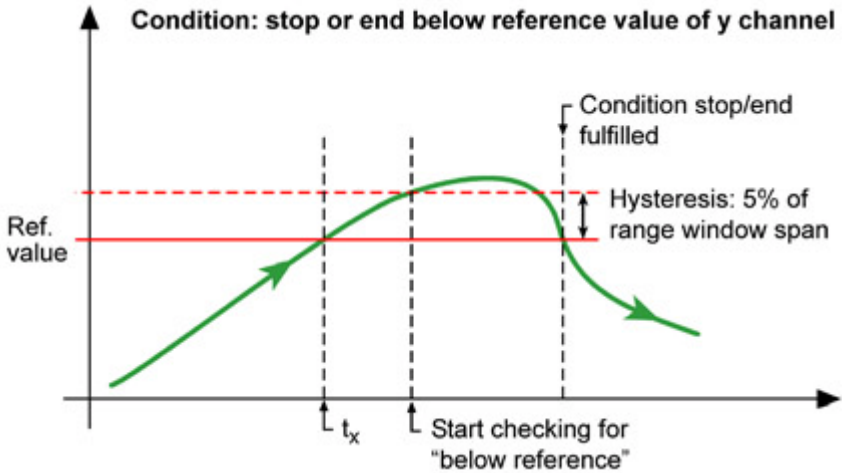

As long as the End condition is not fulfilled, the data in the RAM will not be saved and *no ready message* will be issued, i.e. the *test stand is stopped*.

You can end the measuring of a process as follows:

1. With an external signal ([Start/End process](#)) or manu-

ally via . An interface command works in the same way as the manual control.

You can find the interface commands in the MP85A Operating Manual "Interface Description CAN/Pro-fibus/Ethernet".

The stop and end time points are the same with an external signal as well as with manual control. The two operating modes can also be mixed, i.e. the process will be ended when you either click on the button or the digital “Stop” signal is issued.

2. You can end the measuring when the Start condition has been left again, i.e. you must also start with an (internal) Start condition.

Example: if “above displacement value” is used as Start condition, this means that the displacement value entered for the Start condition must be undercut again, including a hysteresis of 1% of the related axis of the range window.

See Example for leaving the Start condition “Above reference value in x channel” and Example for leaving the Start condition “Above reference value in y channel”

3. With an End condition (internally checked reference value, i.e. measured value of a channel).

 In this case the condition is only evaluated if— with **below reference**—the reference value plus hysteresis has been exceeded once or if—with **above reference**—the reference value minus hysteresis has been undercut once. The hysteresis (5% of the range window) is required so that noises or small disturbances in the signal do not cancel the measuring when the time reaches t_x . The percentage refers to the respective axis of the range window. See Example End condition: below reference value in x channel and Example End condition below reference value in y channel

Notes

- With a process-optimized measurement the ready message is only set if the End conditions are fulfilled *and* the values to be saved are in the RAM. The disadvantage of process-optimized measurement is that with fast running processes it may be that not all processes are saved. If there is no space available in the RAM, the data will be discarded. See also [Storage methods](#)
- With a measurement with no data loss *additionally* enough (older) process data must be transferred from the RAM on to MMC/SD Card or PC so that the values from the next measurement will fit into the memory (RAM). If this is not the case, the system must wait, i.e. the *test stand is stopped*.

For the *Above limit* condition the hysteresis lies *below* the reference value



Abb. 4: Example of a start condition: exceeding an x channel reference value

For the *Above limit* condition the hysteresis lies *below* the reference value.

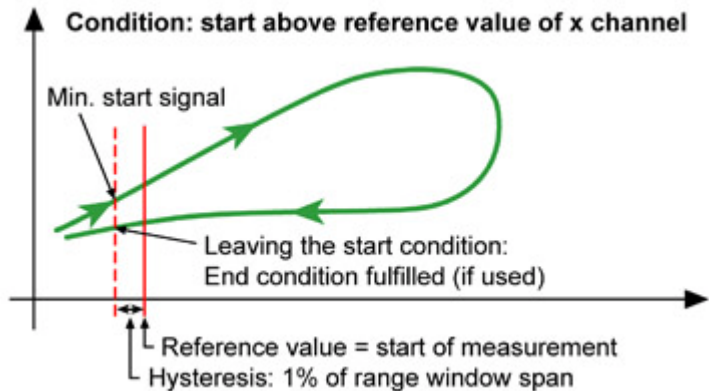

Abb. 5: Example of a start condition: exceeding a y channel reference value

For the *Below limit* condition the hysteresis lies *above* the reference value.

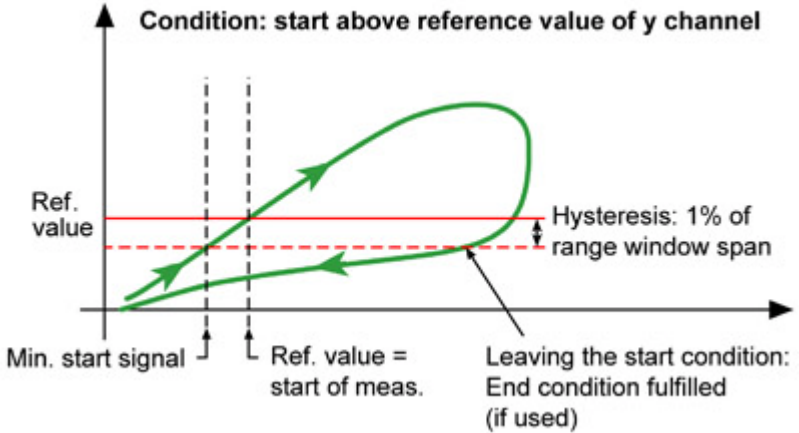

Abb. 6: Example of stop/end condition: Undercutting reference value on x channel

For the *Below limit* condition the hysteresis lies *above* the reference value.

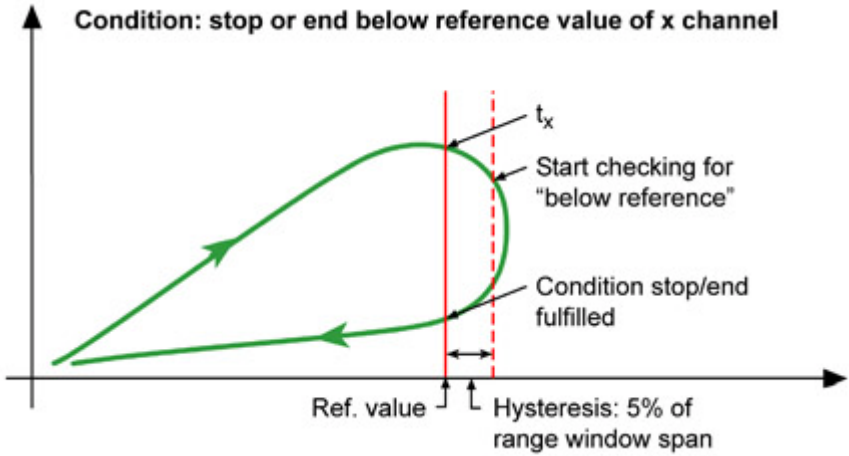

Abb. 7: Example of stop/end condition: undercutting a y channel reference value

4.4 Alarm window



When you first use a new MP85A, the presetting (factory setting) for the alarm window and the range window corner points are identical, i.e. both windows are on top of each other. The presetting for the corner points is $-10/-10$ and $+10/+10$.

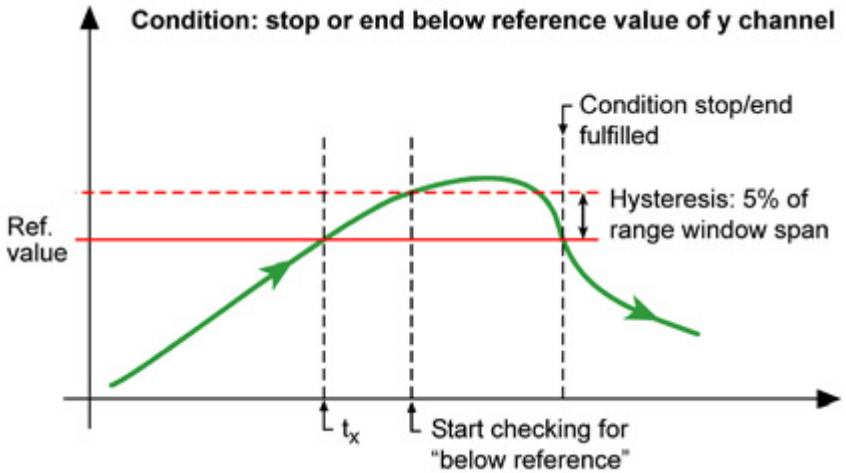

Click on ***Adjust alarm and range windows autom.*** to get suggested values. The alarm window will be set to the measuring range of the transducer enlarged by 15% in all directions; the range window will be set to the measuring range enlarged by 10%. The Δx and Δy of the data reduction will also be set to practice-oriented values for these ranges.

This window is used to monitor the general system status and to protect against overload. You should enter here the limit values (or these values slightly reduced) for the transducer. As soon as measured values lie outside this window, an alarm message is issued and the process is marked as NOK (not OK). The alarm message can be output via the digital outputs or as interface message.



Do not enter 0 as the lower limit if this value could be reached or if a value even slightly lower may occur during *normal* operation. Use instead, for example, a value of -1% of the transducer nominal load.



The alarm window must always be rectangular. Only two corner points can be entered. The alarm window must be larger than all other windows.



See also [Range window](#), [Important information about tolerance windows](#)

4.5 Range window



When you first use a new MP85A, the presetting (factory setting) for the range window and the alarm window corner points are identical, i.e. both windows are on top of each other. The presetting for the corner points is -10/-10 and +10/+10.



Click on ***Adjust alarm and range windows autom.*** to get suggested values. The alarm window will be set to the measuring range of the transducer enlarged by 15% in all directions; the range window will be set to the measuring

range enlarged by 10%. The Δx and Δy of the data reduction will also be set to practice-oriented values for these ranges.

The range window defines the range which is used to record and evaluate the process.



No values will be recorded outside this window and no check is made with regard to any tolerance window.



The range window must always be rectangular. Only two corner points can be entered. The range window must be smaller than the alarm window.

The range window is of advantage if a part of the values measured during the process is not relevant for the evaluation. In figure 1, for example, the section of the curve before the press-fit process starts (marked red) is relatively large and is not necessary for the current evaluation. In practice, the section marked red is not required for the evaluation and is omitted, see figure 2.



See also [Alarm window](#), [Important information about tolerance windows](#)



Abb. 8: Example of a process for a range window



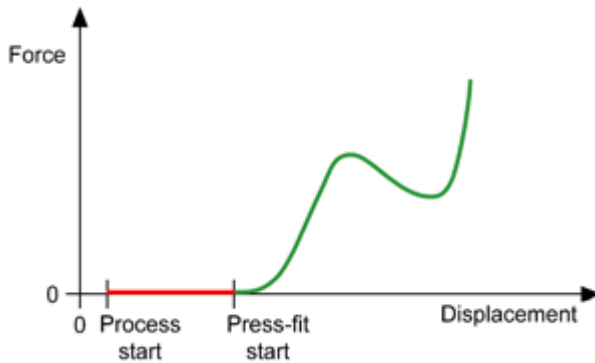

Abb. 9: Example of the application of a range window

4.6 Test measurement (start measurement manually)

Start a measurement manually or allow the measurement to be carried out automatically in order to be able to use

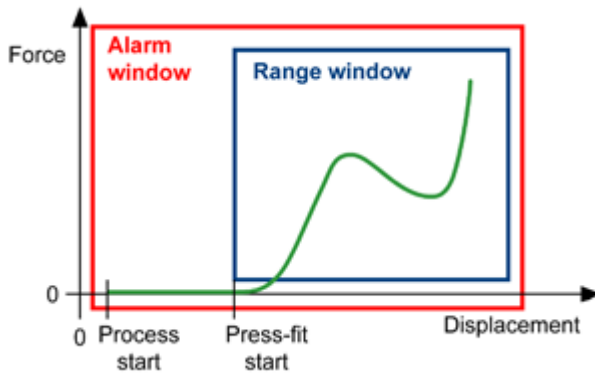
this data to determine the required tolerance windows. The curve should correspond to a typical process. There are two possibilities of doing this:

1. **Method 1:** Perform measurements using Start/Stop/End conditions; in doing so you can use digital inputs additionally or exclusively (the measuring starts if the Start condition is fulfilled or the start/end input is set.)

2. **Method 2:** Use  (Start process) and  (Stop process) located at the window top.

Use the Start and End conditions ***External signal*** on the **Control settings** tab, without the signals being present, or ***Standstill recognition*** with a correspondingly long time.



No process (no measurement) is started as long as a transducer error is present and the MP85A is not capable of measuring.

The status of the measurement (measuring or finished) is shown on the left-hand side of the status line at the bottom of the window. Please note that any window properties may be edited only if a process is ended.



Measuring reference curves also creates statistical values. Therefore deactivate the statistical data handling or delete the statistics after such measuring operations. See [Statistical data handling](#), [3D graph \(MEASURE + VISUALIZE\)](#)



See also [Control settings](#), [Data reduction](#)

4.7 Important information about tolerance windows



See also [Consider window sequence](#), [Data reduction](#)

- All windows are monitored simultaneously. The entry condition(s), i.e. the x or y coordinate, is/are monitored first for each window. If one is fulfilled, i.e. the coordinate is exceeded or undercut, only the exit condition(s) is/are then monitored for *this* window. The monitoring is unchanged for all other windows.
- If a window has been evaluated once (OK or NOK), this window is no longer considered in the successive evaluation, even when the curve passes through the window once again. In such cases use several windows and the option *Consider window sequence*. Each tolerance window has a number, the individual windows can be evaluated in numerical sequence. This means window no. 1 must run *before* window no. 2.
- The sides where the measurement curve enters and exits the window must always lie *parallel to the coordinate system*. The program converts other window shapes automatically as soon as the corresponding side is defined as entry or exit side. In Fig. 1 at first only the vertical line at x_1 is monitored. If it is crossed, a check will be made to ensure that the value lies within y_1 and y_2 , then the exit is monitored and after that the exit condition will be checked. With an online window (evaluation in real-time) this check is carried out as soon as x_1 is exceeded. The evaluation NOK can therefore occur with an online window as soon as x_1 is exceeded.

- If the same coordinate axis is monitored for two windows and the same entry condition, then either the coordinates for windows to be passed consecutively in the direction of the entry condition must also be located one after the other (becoming larger for exceeding or smaller for undercutting) or you must use the option *Consider window sequence*.

In Fig. 2 (Consider window sequence, example 2) the process is then only evaluated with OK when the window sequence is considered: the entry coordinate y_1 of window 3 is lower than that of window 2 (y_2). If y_1 is exceeded, window 3 would therefore be checked first and evaluated with NOK; window 2 would be evaluated only at y_2 . The coordinates x_1 and x_2 do not present a problem, because x_2 in the direction of the entry condition is greater than x_1 and is therefore also only evaluated later.

If a curve has a trace as in Fig. 3 (Consider window sequence, example 3), then the coordinate x_1 is simultaneously monitored for both windows, but for the first time the curve can only pass through *one* of the windows. The other window would therefore always be classified as NOK (not OK). Here therefore *Consider window sequence* would also have to be activated.

- If *one* window should be passed through *several* times (e.g. backwards and forwards), the procedure will be identified as OK in this window as long as *one* run fulfills the conditions defined. However, if the window has been evaluated once, e.g. because the entry condition was fulfilled, the window is *no longer considered*.

- You can use *only rectangular shapes* for windows with [Real-time evaluation](#). Only windows which are configured for evaluation *after the measurement*, can have a shape other than rectangular, e.g. trapezoid or parallelogram.
- The *side edges* of a window *may not overlap*. For example, you cannot pull the bottom right-hand corner over the top right-hand corner.



Abb. 10: Monitoring x on entry



Abb. 11: Consider window sequence: Example 2

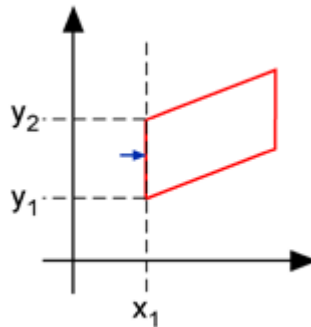

Abb. 12: Consider window sequence: Example 3

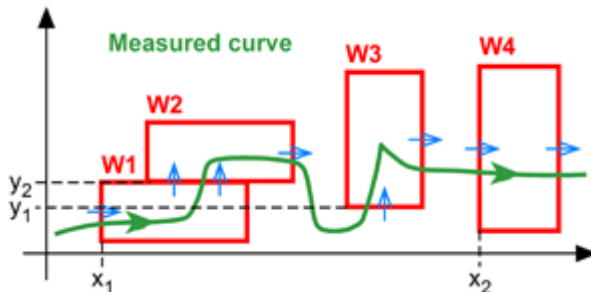

Abb. 13: Possible window shapes

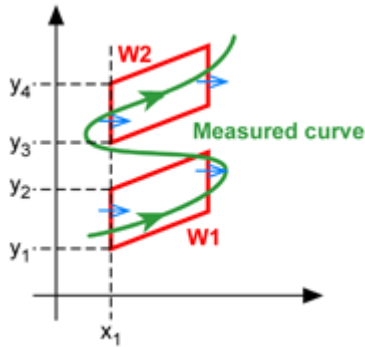

Abb. 14: Impermissible window shapes

4.8 Defining tolerance windows



Tolerance windows must lie *inside* the range window.

The measured values are evaluated with the help of this window. There are two different methods of evaluation:

1. Real-time evaluation, i.e. during the measurement



Evaluation in real-time is only possible for absolute (not for relative) windows and only rectangular windows can be used.

2. Evaluation when the measurement has finished

The basic settings for tolerance windows can be seen on the **Tolerance window** tab in the **Properties** frame. Use **Change** to call the dialog window and adjust all settings, as well as the information concerning the entry and exit evaluation and which statistical data will be collected (evaluation matrix).



Limit values are taken into account in the process evaluation in addition to the tolerance windows if **Use status in total result** is activated, see [Limit values](#).



You may also use the EASYteach module (FASTpress Suite) to create or modify tolerance windows, see [EASYteach](#).



See also [Alarm window](#), [Range window](#), [Important information about tolerance windows](#), [Test measurement \(start measurement manually\)](#), [Data reduction](#)

4.8.1 Creating and modifying tolerance windows

Creating tolerance windows

Up to nine windows can be defined, four of them may be real-time windows. The windows are created in the graph

using the mouse and context menu item **as tolerance window**.

- The individual *windows may overlap*.
- Windows which are to be evaluated in real-time *must always be rectangular*. The program will change the corner points automatically when necessary. The entry and exit sides of tolerance windows must be parallel to the coordinate system.

All windows must be assigned a name and number on creation. If you later select **Consider window sequence** for the evaluation, the number of the window determines the sequence in which it will be processed. Windows with higher numbers will be processed after those with lower numbers.

If necessary you can insert a window *in-between* two existing windows. Assign the relevant number. The window already having this number and the following ones will then be renumbered. However, the names will not be changed. Use **Rename** to change the name of a window.

Modifying tolerance windows

- To move a window, click on the window name, hold the left mouse key down and then drag.
- You can also move the corner points of the window by holding down the left-hand mouse key.
- Click on the window name in the graph to display the window settings. Click on **Change** on the **Tolerance window** tab to call the properties dialog and change settings.



See also [Important information about tolerance windows](#)

4.8.2 Window active

You can deactivate a window temporarily. All other settings remain unchanged.

4.8.3 Consider window result in total result

This option allows you to monitor a curve range with a window without the results being considered as OK or NOK in the overall result.

You can either temporarily suppress the evaluation in the overall result for a window or set up an additional window that alerts about even smaller differences than those permitted for a process which is still evaluated as OK. In example 1 manufacturing tolerances are monitored which indicate wearing of certain tool parts (Error 1 to 4).



Abb. 15: Tool wear: Example 1

4.8.4 Crossing window with min/max evaluation

This is the standard window type. Using [Evaluation of entry and exit](#) and [Statistics and class counting](#), define which data is to be checked and further processed for the window.

Example: Crossing window with entry and exit conditions (left/right) and the y min/x min statistical data thereby acquired.

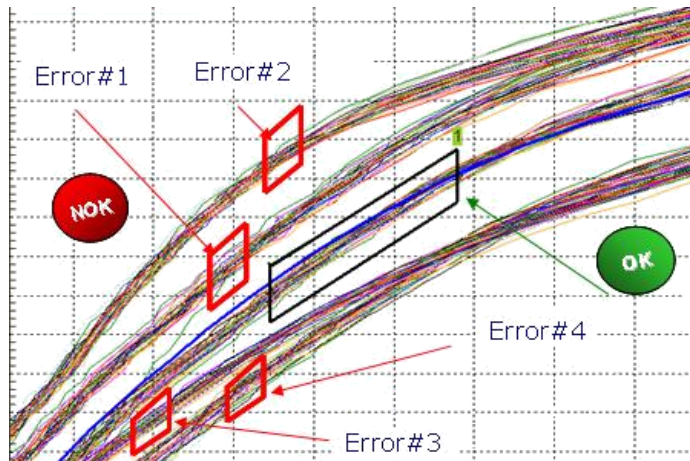
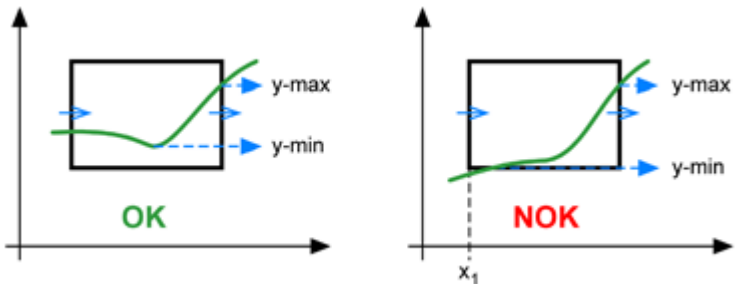

If the option **Evaluate window in real time** is active, you obtain an error message (NOK) in the example on the right when the coordinate x_1 is exceeded.

4.8.5 Crossing window with evaluation of the y mean

The window for this evaluation must be *rectangular*; the evaluation is carried out *after* the measurement. The corner points are changed automatically by the program if required. Details about entry and exit are *not* considered with this evaluation and are also not needed.

The actual readings are not evaluated, but rather the y mean, which arises for a section of the x axis of the window.

Example: The mean is obtained of all y readings between x_1 and x_2 . Then a check is made of whether this *mean* lies within the window shown in red here.

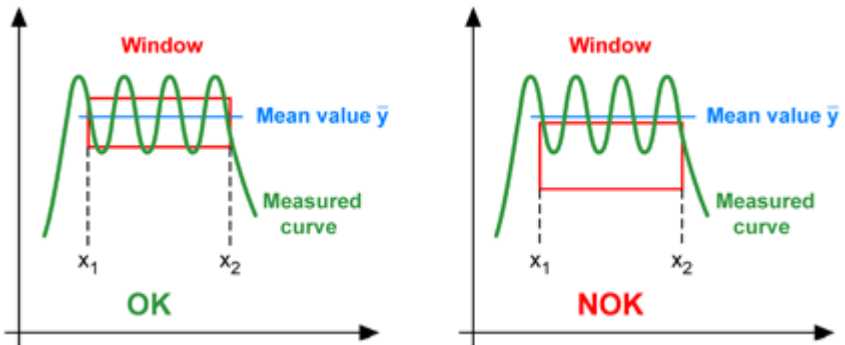

4.8.6 Crossing window with evaluation of the x mean

The window for this evaluation must be *rectangular*; the evaluation is carried out *after* the measurement. The corner points are changed automatically by the program if required. Details about entry and exit are *not* considered with this evaluation and are also not needed.

The actual readings are not evaluated, but rather the x mean, which arises for a section of the y axis of the window.

Example: The mean is obtained of all x readings between y_1 and y_2 . Then a check is made of whether this *mean* lies within the window shown in red here.

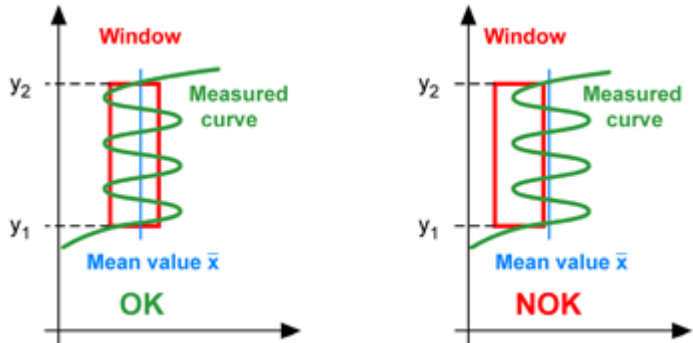

4.8.7 y limit



Use the limit [values](#) for real-time monitoring of safety-relevant values.

The window is displayed as just a single line; all y coordinates are identical and the exit is not evaluated. In the default setting the threshold must be crossed from below to above, but you can change this by changing the entry side.

This type of window is suitable for initiating trigger signals or for monitoring minimum values and is usually combined with the option **Evaluate window in real time** or **Consider window sequence**.



Use the **Consider window sequence** option and define a [digital output](#) which outputs the **tolerance window x OK** to detect when the trigger threshold is reached.

4.8.8 x limit



Use the limit [values](#) for real-time monitoring of safety-relevant values.

The window is displayed as just a single line; all x coordinates are identical and the exit is not evaluated. In the default setting the threshold must be crossed from left to right, but you can change this by changing the entry side. This type of window is suitable for initiating trigger signals or for monitoring minimum values and is usually combined with the option **Evaluate window in real time** or **Consider window sequence**.

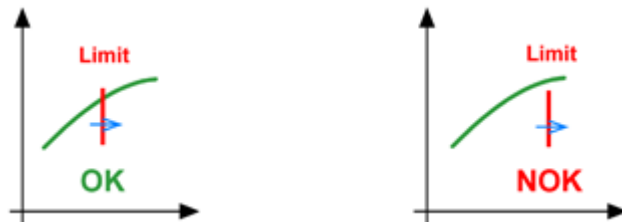

Use the **Consider window sequence** option and define a [digital output](#) which outputs the **tolerance window x OK** to detect when the trigger threshold is reached.

4.8.9 Block window (end window)

With a block or end window the plot only enters the window, but must no longer leave it. This is different to the threshold where the exit is not evaluated at all nor considered. With the block window any exit is evaluated as an error.

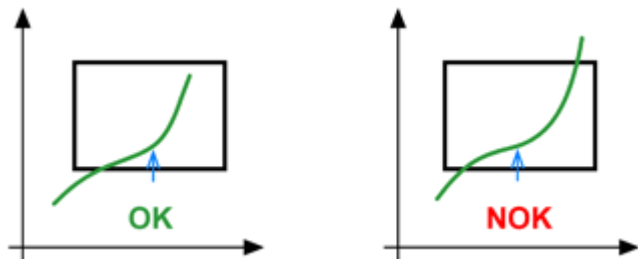

4.8.10 Switch test



The functions for the switch test are only available with an MP85A-S (version for the switch test).

The switch test checks whether the switch in this window changes its state. Specify **Close** as the **switching direction** when the switch in this window has to change its state from "Open" to "Closed", otherwise specify **Open**.

The check is made via one of the [digital inputs](#) of the MP85A-S; specify the input used under **Switch input**. If the switch bounce is to be ignored, activate the appro-

ropriate option. Otherwise the switch bouncing is evaluated as NOK.

Note

- This window type cannot be used as a relative window.
- The evaluation takes place once the measurement has stopped, i.e. the real-time evaluation cannot be selected.
- The bounce of a switching process (switching on or off) is evaluated a maximum of 16 times in each case. If further bounces occur, the measurement is interrupted and the evaluation (statistics, etc.) is started. The process is generally labeled with NOK except when all windows have been evaluated with OK, i.e. bouncing only occurs with the last window.
- If the available digital input of the MP85ADP-S is not sufficient, you can transfer up to four switching events to the MP85ADP-S for evaluation (software input) via the interface.
- In the graphs an I, the number of the digital input and 1 as well as the symbol Δ on the plot are displayed for **Close**; for **Open** Ix:0 and ∇ as symbol are displayed. If, for example, the switch on Digital Input 1 has closed, then Δ appears as a tag on the plot with I1:1 above it. In the following example switch-on occurs in the window (OK), switch-off outside (NOK); Input 3 is used as a digital input.

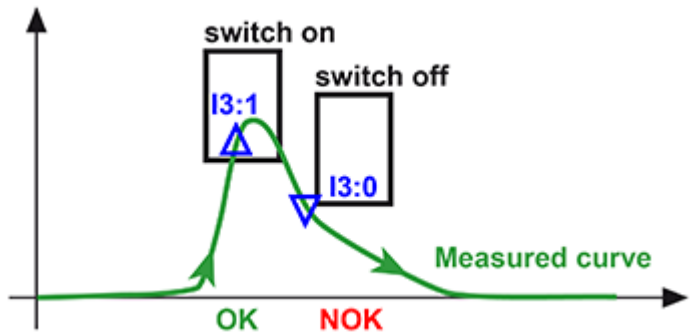

- No entry or exit sides are needed for this window type.
- In the statistics the minimum/maximum values occurring in the window are not displayed, but rather the switching coordinates, i.e. the coordinates at which the switch has changed its state. In addition to **OK** or **NOK**, **No switching process** is displayed when the switch has not changed its state or **Switch process repeated** if multiple switching has taken place.

4.8.11 Haptic test



The functions for the haptic test are only available with an MP85A-S (version for the switch test).

The haptic test checks *how* the switch in this window changes its state, i.e. the "feel" during operation. Specify the required forces and displacements for this in the haptic test dialog: **Set** button. You can check only one parameter, a combination of any parameters or all the listed parameters. The test is NOK when *one* of the activated parameters is not satisfactory. The graph below shows the single parameters.

During the haptic test the plot must enter and exit the window at the side and only rectangular windows are admissible. Entry or exit on the upper or underside of the window is not possible.

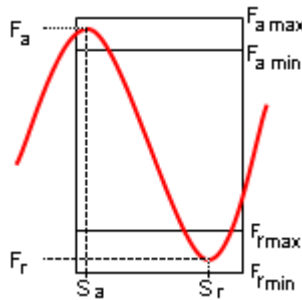

Verifiable haptic parameters

- Switch actuating force F_a :** Specify the minimum switch actuating force $F_{a\ min}$ and the maximum switch actuating force $F_{a\ max}$. The switch actuating force is the force required to move the switch from the inoperative position over the switching point. The maximum switch actuating force $F_{a\ max}$ is determined by the upper edge of the window.
 -  The entered value for $F_{a\ min}$ is indicated in the window by a violet line. You can also change the value by clicking and dragging the line.
- Restoration force F_r :** Specify the maximum restoration force $F_{r\ max}$ and the minimum restoration force $F_{r\ min}$. The restoration force is the force at which the spring mechanism switches back. The minimum restoration force $F_{r\ min}$ is determined by the lower edge of the window.

 The entered value for $F_{r\max}$ is indicated in the window by a green line. You can also change the value by clicking and dragging the line.

- **Differential force:** Define the minimum required and the maximum permissible difference from the actual switch actuating force F_a and the actual restoration force F_r .
- **Differential displacement:** Define the minimum required and the maximum permissible displacement between the actual switch actuating force F_a and the actual restoration force F_r .
- **Force/displacement ratio:** Define the minimum required and the maximum permissible ratio between the differential force and the differential displacement.
- **Click ratio:** Define the minimum required and the maximum permissible relative differential force. With this test the differential force is calculated in percent of the switch actuating force and compared with the stated values.

4.8.12 Evaluation in real time window option (online window)

You can also use this window type for machine and plant protection. In contrast to the alarm window here you can define that the measurements are specially checked in a certain section of the process. However, with this option you can *only use a rectangular* window. The option also excludes evaluation via relative coordinates (relative window), because they are only fixed after the measurement. For a crossing window with min/max evaluation in

real time you obtain an error message (NOK) in the example on the right when the coordinate x_1 is exceeded.

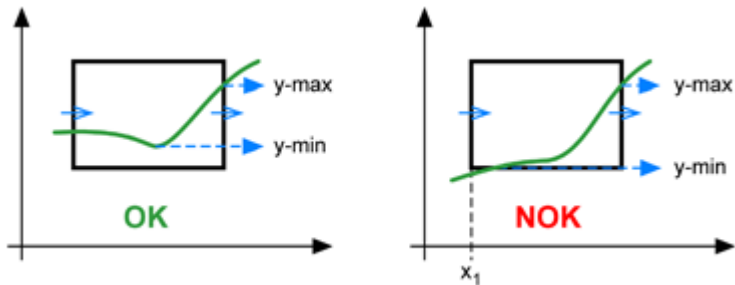

To create a *merge window*, use a crossing window with min/max evaluation which is evaluated in real time (Example). In addition, define a [digital output](#) which outputs **tolerance window x OK**. You then receive a message when Point x_1 is exceeded and the plot has not entered the window on the left side or if the window is exited above or below in the subsequent progression.

A maximum of four windows can be evaluated in real time. The window sequence can also be taken into account with evaluation in real time.



Abb. 16: Example of a merge window

4.8.13 Consider window sequence

The option is of particular interest when the measured curve passes through a range twice or when, for example, with hysteresis curves a certain sequence is to be maintained when crossing. The option can be selected separately for each window, i.e. you can define windows with and without evaluation of the sequence. However, we recommend that either the option **Consider window sequence** is activated for *all* windows or for *none*. If required, you can place a window *between* two existing ones by specifying the corresponding number (again). Windows with this number and higher numbers are then renumbered, but the names are retained.

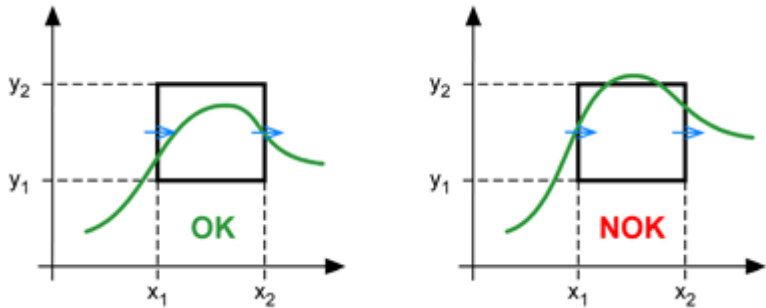

The option is indispensable when the *same* x or y range is crossed *twice in the same direction* (Example 1) or when, with two windows, the same coordinate axis is monitored for the entry condition and the coordinates for windows to be crossed consecutively in the direction of the entry condition are not positioned consecutively (Example 2): the

entry coordinate y_1 of Window 3 is lower than that of Window 2 (y_2). If y_1 were to be exceeded, window 3 would therefore be checked first and evaluated with *NOK*; window 2 would be evaluated only at y_2 .



If you are evaluating windows normally (after the measurement) as well as *in real time* (during the measurement), the window sequence is *taken into account first only for the real-time windows*, i.e. windows occurring in the sequence, which are not to be evaluated in real time, are also not taken into account. All other windows are taken into account only after the measurement.



The option of whether the next sequence window is monitored (becomes active) when the measured curve has *entered* the current sequence window or only when the current sequence window has been *exited* applies to *all windows* for which the window sequence is monitored. The evaluation of the sequence window with OK or NOK is independent of this, i.e. the exit condition is also checked in the first case. However, the entry condition for the next sequence window is in the second case only monitored once the current sequence window has been exited.

Examples

- In Example 3 the curve must first cross Window 1 and then Window 2. Since the MP85A always monitors coordinate ranges, with the simultaneous monitoring of *both* windows *without* a sequence and the entry and exit directions identified by the blue arrows Window 1 would be evaluated as “OK” (in order) and

Window 2 as “NOK” (not in order) after the first section of the curve. OK for both windows only occurs when the sequence is taken into account: Since Window 2 is only “active” when Window 1 has been crossed, the same coordinate x_1 can now be monitored twice.

 The fact that the curve in Example 3 again crosses Window 1 at the upper corner is *not evaluated*, because the window has already been crossed and is therefore no longer considered in the further monitoring. Here, it does not matter whether the window has been evaluated with IO or NIO.

- In Example 4 after passing through Window 1 the curve enters Window 2 first before passing through Window 3. With the entry and exit directions indicated by the blue arrows the process is labeled as OK, irrespective of whether the sequence is taken into account or not.
- In Example 5 the process *is only* “OK” when the *sequence is not* evaluated, because here the windows are crossed in the sequence $F1 \rightarrow F3 \rightarrow F2$.
- You can carry out a test also through a suitable selection of entry and exit conditions. In Example 6 the process is “not OK”, because Window 2 is crossed in the wrong direction. In Example 7 the process is however “OK” and namely *independently* of whether you are working *with **Consider window sequence** or not*: although Window 3 was crossed once in the wrong direction, it was also crossed once in the right direction. Even the sequence $F1 \rightarrow F2 \rightarrow F3$ was maintained here, so the process is “OK”. If however, as in Example 8 the Window F2 were larger, then the entry

condition would be infringed and the total process would be “not OK”.



Abb. 17: Consider window sequence: Example 1



Abb. 18: Consider window sequence: Example 2

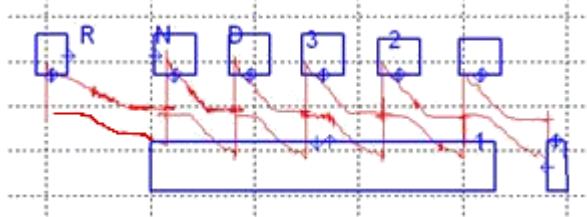

Abb. 19: Consider window sequence: Example 3

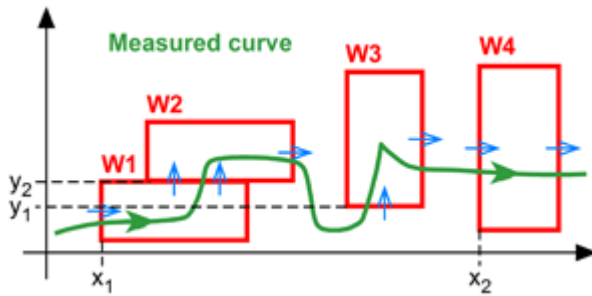

Abb. 20: Consider window sequence: Example 4

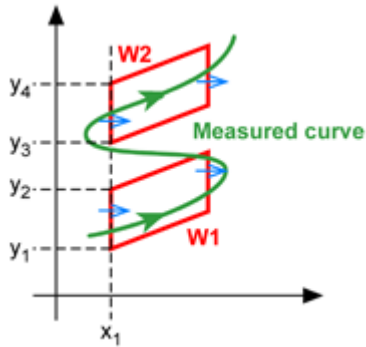

Abb. 21: Consider window sequence: Example 5

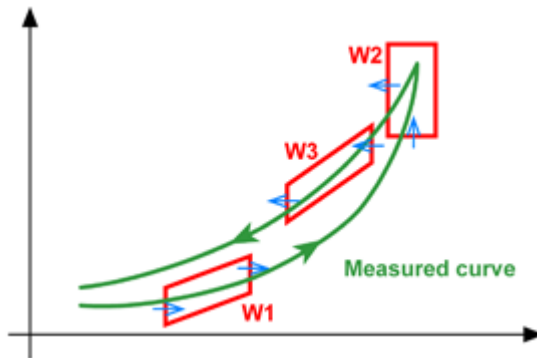

Abb. 22: Consider window sequence: Example 6

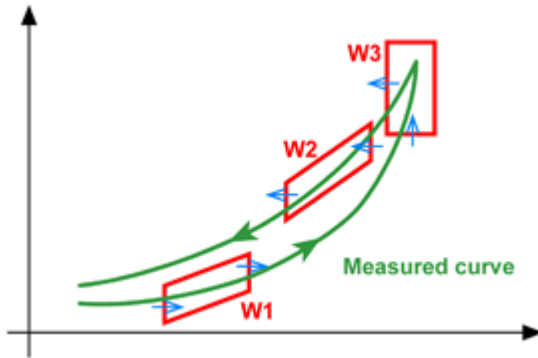

Abb. 23: Consider window sequence: Example 7

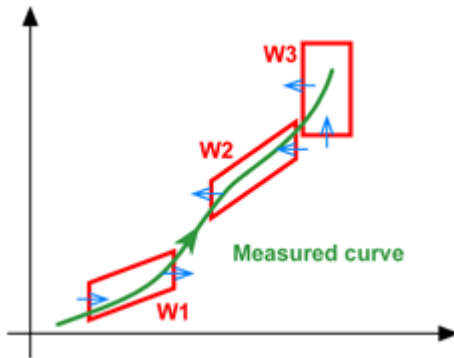

Abb. 24: Consider window sequence: Example 8

4.8.14 Window option y coordinates relative

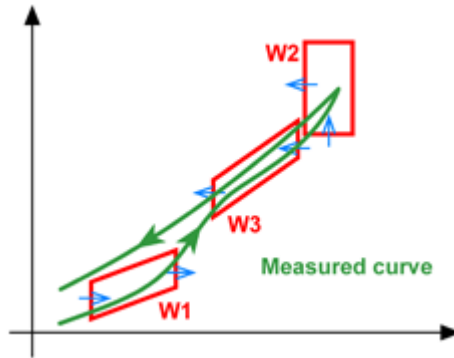
With this option you can evaluate the plot relative to the minimum, maximum or mean which has been attained within the *second* tolerance window. The windows linked in this way are moved upwards or downwards in parallel

to the y axis depending on the position of the value. The selected reference point applies to all windows with relative y coordinates.

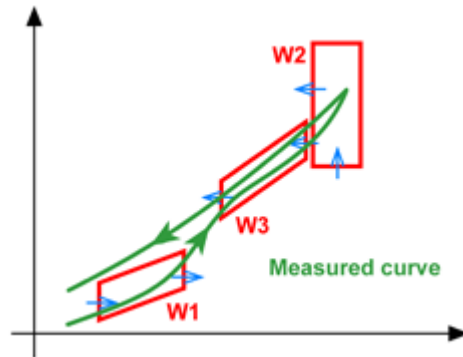
Note

- Relative coordinates can only be used for evaluation after the measurement (*no evaluation in real time*). With this option the *second* tolerance window is always used as a reference. If required you can create a new "second" window by issuing the number two (again). Windows with this number and higher numbers are then renumbered, but the names are retained.
- You must set the second window for the calculation which corresponds to the condition applied here, i.e. for the evaluation "relative to the mean" the [y mean](#) in the second window must be calculated.

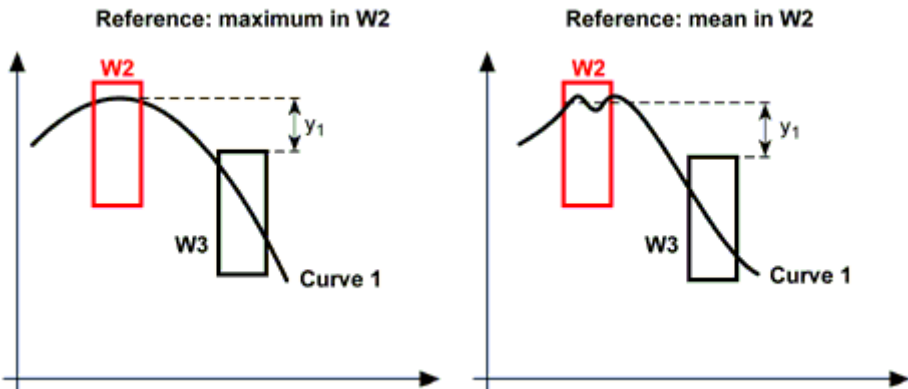

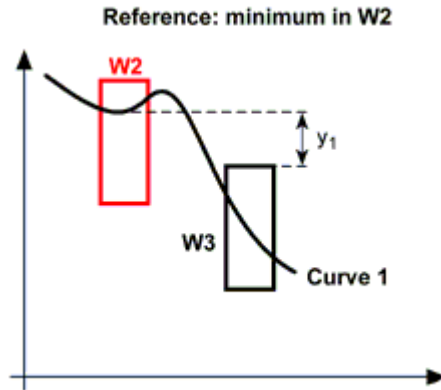

 Refer also to [Display differences with relative windows](#).

4.8.15 Window option x coordinates relative to

With this option, the coordinates are converted relative to a later position (reference point) and related, for example, to the end position or thread-in position. The selected reference point applies for all windows with relative x-coordinates.

 Relative coordinates can only be used for evaluations made *after the measurement* (no real-time evaluation).

Evaluation referenced to the end position

The end position reached is set to the specified value, all x coordinates are then recalculated before the relative windows are evaluated.

Evaluation referenced to the y channel

If the “Start conditions” for the process vary significantly, e.g. because the process started using very different measured values on the x channel (see example below), let the evaluation be carried out in relation to a reference point on the y channel and use relative windows. All measuring curves will be moved so that for the reference point they go through the same coordinates on the x axis, i.e. all x coordinates are converted accordingly before the relative windows are evaluated.



See also [Presentation differences in relative windows](#)



Abb. 25: x coordinates relative: Example 1



Abb. 26: x coordinates relative: Example 2

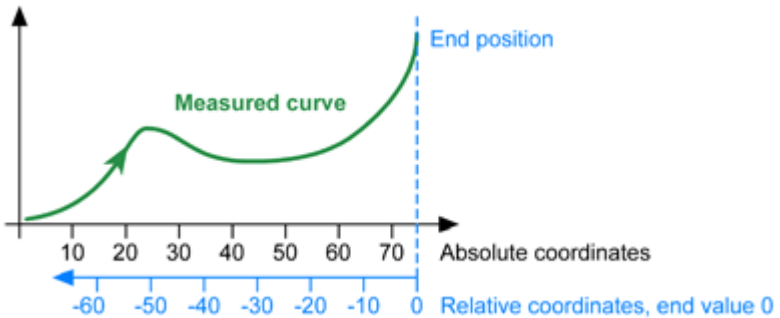

Abb. 27: x coordinates relative: Example 3

Example: Spreading measured curves

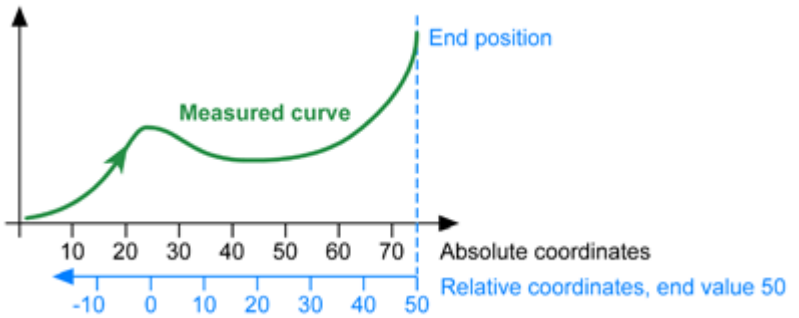

For Measured curve 1 the window $W1$ (red) is located relative to the displacement point s_1 (reference point of y channel exceeded): position $W1_1$. For Measured curve 2 the window is displaced to the position $W1_2$, because here positioning occurs relative to s_2 . Without a relative window the window $W2$ (area filled in gray) would be needed, i.e. a very large window.

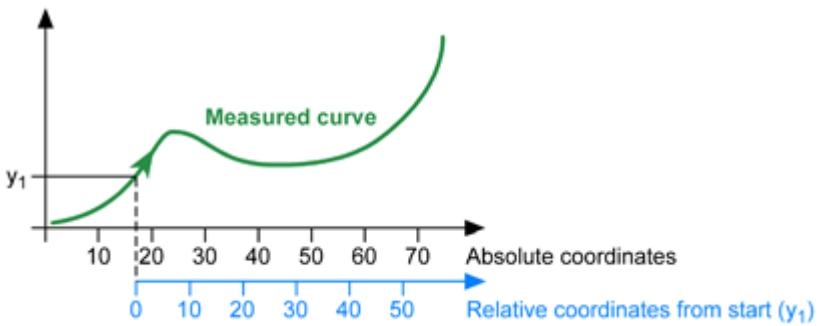
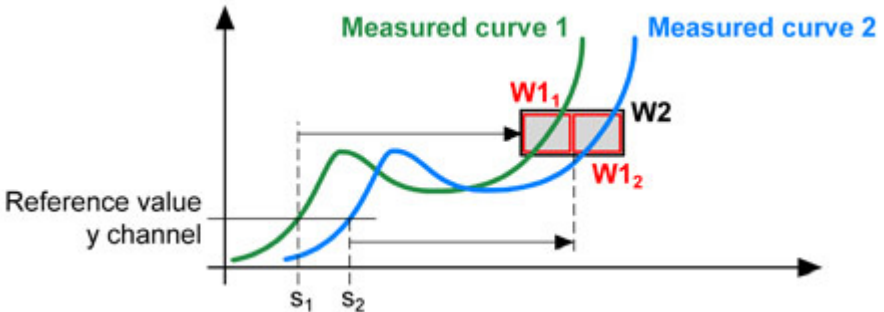
4.8.16 Evaluation for entry and exit of window

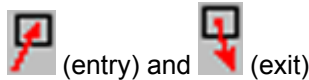

After a window type has been selected, default values will be preset. However, these values can be changed if necessary, e.g. you can set more than one side for entry and exit. If the settings lead to another window type, also on the left of the dialog the window will be marked as another type, e.g. if you have not entered a side for the exit, a *pass-through window* will become a *block window (end window)*.

If you use ***Don't evaluate exit***, *only the entry* into the window will be tested. Therefore it doesn't matter whether the curve leaves the window (in this case all fields should be marked) or whether it remains within the window (block window, no field marked), the window will be evaluated with OK as soon as the entry condition has been fulfilled.



The entry and exit sides are always evaluated parallel to the coordinate system. If necessary, the program will change the corner points automatically when closing the dialog.

Examples

In the window in example 1, the coordinate x_1 is evaluated as entry side. The corresponding y value (black arrow) is checked to see whether it lies within the window, i.e. that it is less than y_{2a} and greater than y_{1a} . On the exit side, the coordinate x_2 is checked to see whether the y value lies between y_{1b} and y_{2b} . In example 2, the exit side is at the top, therefore this side of the window must run horizontally. The y_2 position is checked to see whether the x coordinate lies in the window. This is the case with the picture on the left. The window will therefore be marked as passed through, i.e. as OK.

The exit and entry sides and window coordinates must always be seen in connection with the evaluation. The MP85A always monitors the entry side coordinates first. The exit side is unimportant at this point. As soon as the window is entered, only the exit side is then monitored. For the evaluation (OK/NOK) it is then checked, whether the curve runs correctly between the valid entry and exit points in the window.



Abb. 28: Evaluation of entry and exit: Example 1



Abb. 29: Evaluation of entry and exit: Example 2

4.8.16.1 Error messages on tolerance window violations

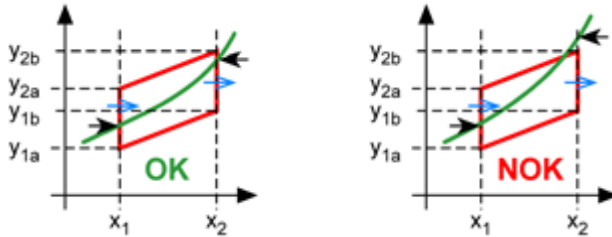
With an infringement of the specified entry and exit sides of a tolerance window there are several possible error messages. To simplify the classification of the error messages, you will find possible (incorrect) plot progressions in the following illustrations with examples.

Entry condition not fulfilled

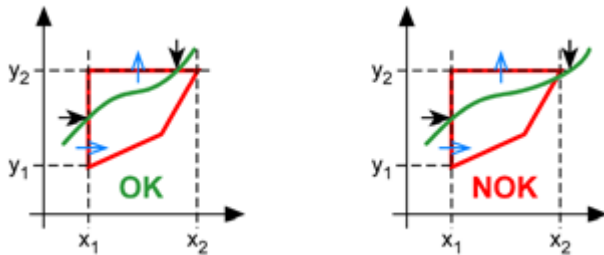
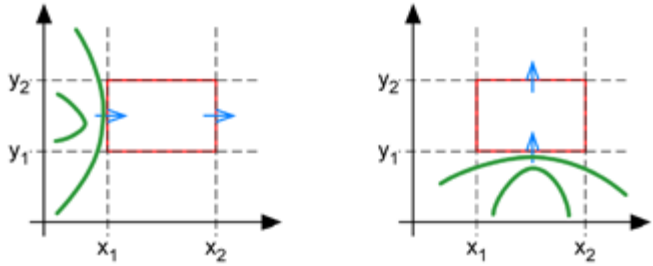
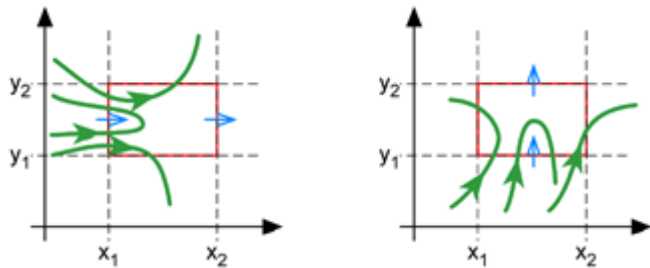
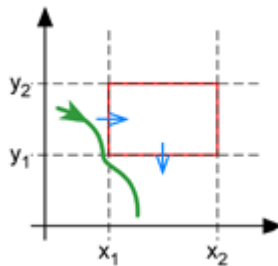
Exit condition not fulfilled

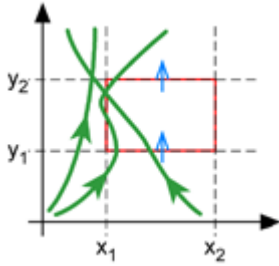
Exit condition fulfilled before entry condition

Error Min. x (x too small)

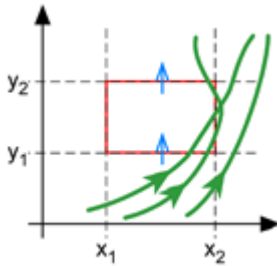

Error Max. x (x too large)



Error Min. y (y too small)

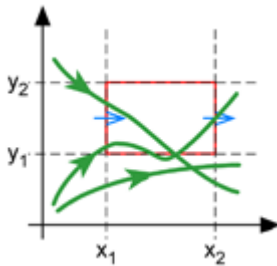

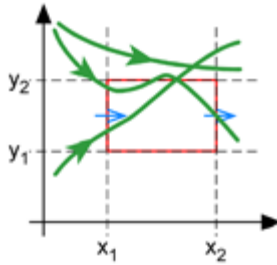
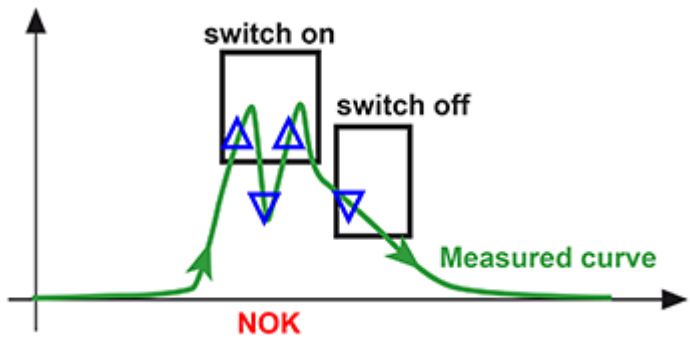
Error Max. y (y too large)**Switching process repeated (only for MP85A-S and switch testing)**

No switching process or an unexpected switching process (only for MP85A-S and switch testing)

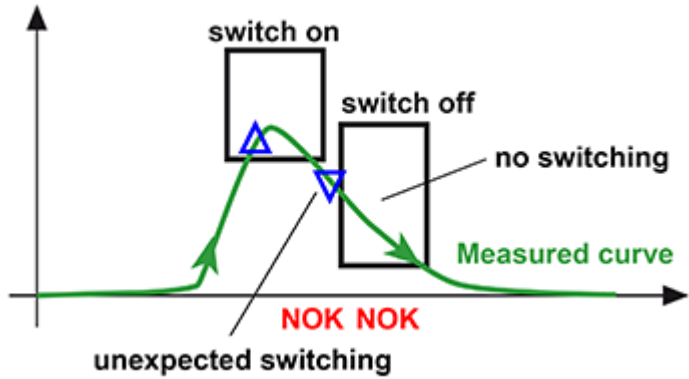

Switch actuating force too small (only for MP85A-S and haptic test)

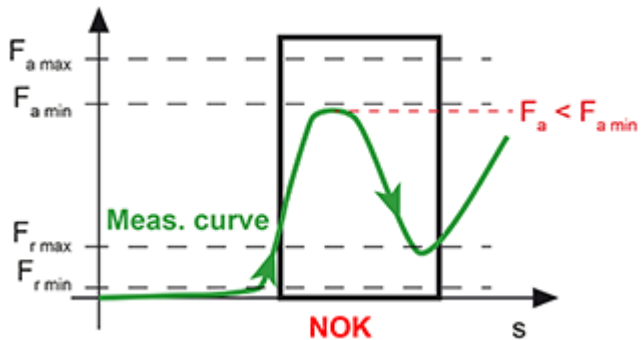

Restoration force too large (only for MP85A-S and haptic test)

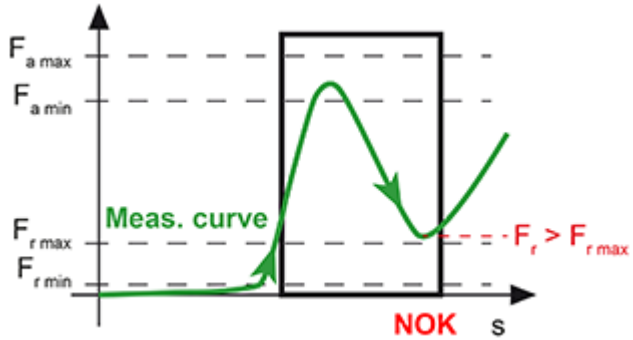

Differential force undercut (only for MP85A-S and haptic test)

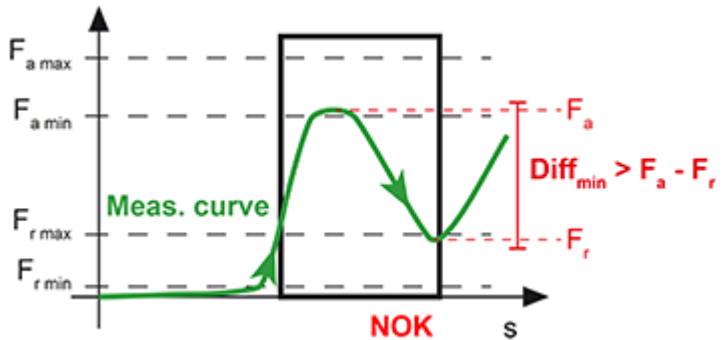

Differential displacement undercut (only for MP85A-S and haptic test)

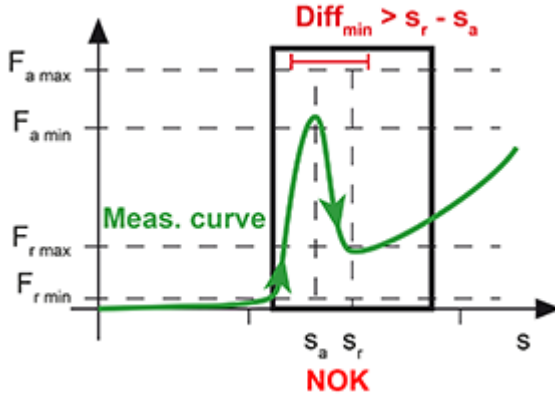

Force/displacement ratio undercut (only for MP85A-S and haptic test)

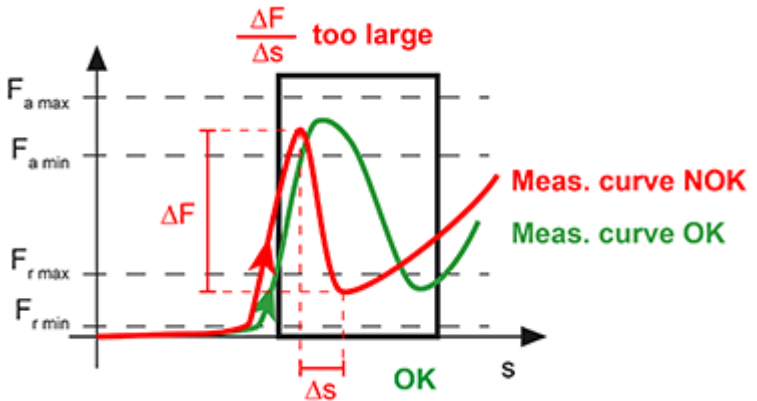

Click ratio undercut (only for MP85A-S and haptic test)

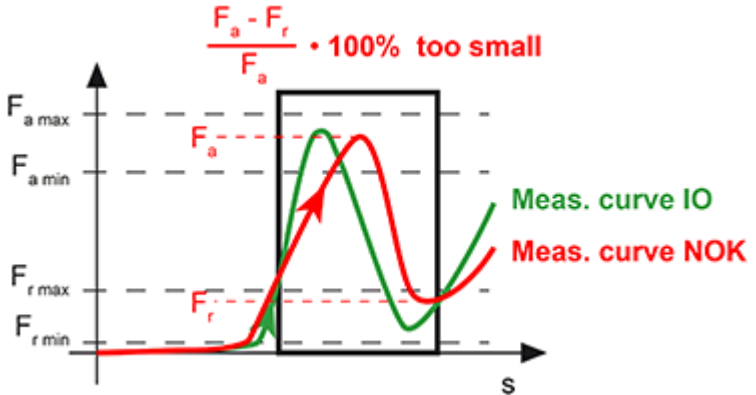

4.8.17 Statistics and distribution (bin counting)



To delete statistical data, see [3D graph](#)



Specify which values should be used for statistics in the third column of the evaluation matrix. The edges lying vertical to the entry/exit sides are normally used. The range between the minimum and maximum end point coordinates of the window are divided into five ranges (classes) of equal width. Another class of the same width is laid on each edge. This means that there are seven classes plus two classes for “outside”.

Example 1 shows the division for a tolerance window where **y-max** and/or **y-min** was marked and the entry/exit sides are **Left** and **Right**. Example 2 shows the distribution for a trapezoid tolerance window, where **y-max**

and/or **y-min** has been marked and for which the entry/exit sides are **Left** and **Right**.

If **y max** is marked, the *maximum values* occurring in the tolerance window range are counted. If **y min** is also marked, the *minimum values* are counted too. These values are displayed in the [MEASURE + VISUALIZE](#) windows. In [example 3](#) you see the effect for a tolerance window where **y-max** and **y-min** were marked and for which the entry and exit sides are **Left** and **Right**. For y-min the counter in class 1 is increased by 1 (one event), for y-max the counter in class 3 is increased by 1.

Example 4 shows the distribution for a rectangular tolerance window where **x-min** and/or **x-max** were marked and for which the entry/exit sides are **Bottom** and **Top**.

As the calculation of the distribution is always carried out with the respective smallest and largest corner point values of a window, values can also appear in one of the five classes which actually lie outside the selected window. The window in example 5 is marked as NOK (not okay). Nevertheless the minimum is counted in class 1 and the maximum in class 3.



Measuring reference curves also creates statistical values. Therefore deactivate the statistical data handling or delete the statistics after such measuring operations. See [Statistical data handling, 3D graph](#) (**MEASURE + VISUALIZE**)



Abb. 30: Class division for the statistics (y min/max)



Abb. 31: Class division for the statistics (trapezoidal window)

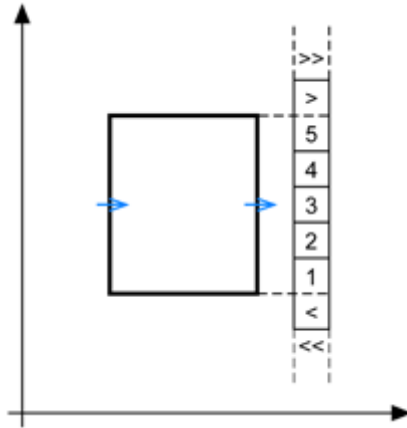

Abb. 33: Class counting in NOK windows

5 Monitoring with tolerance band: settings

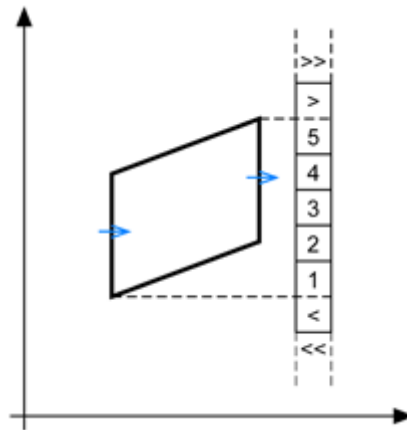
Defining the evaluation criteria for a tolerance band is a multi-stage process which also theoretically cannot normally be carried out, but is rather one for which you need many measurements. The measuring chain must therefore already be fully adjusted; refer to [Adjusting the measuring chain](#).

Enter **Tolerance band** as the evaluation mode under **Define evaluation mode**.

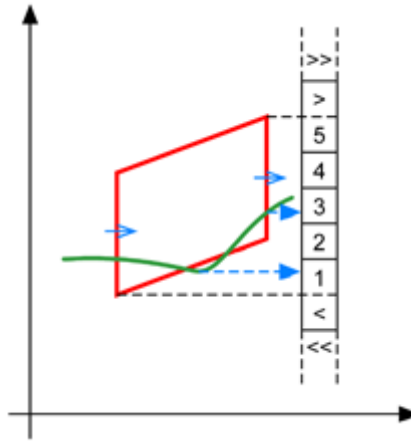

In the tolerance band mode only processes can be monitored in which the x values increase in one direction (no outward and return movement).

If you change the evaluation mode, you should clear the statistical data, because they are not relevant to the new mode and could distort a new result (refer to [3D graph](#)). You can also clear the process counter using the **Process** menu (the **Set evaluation parameters** window must be open). Resetting the process counter however also affects the [file names](#). Back up, if necessary, files already produced, because counting starts at 1 again after resetting.

We recommend that you proceed as explained in the section [Basic procedure](#), if you are making these settings for the first time.

- [Basic procedure](#)
- [General information about the Set evaluation parameters window](#)
- [Control settings](#)

- [Alarm window](#)
- [Range window](#)
- [Tolerance band](#)



[Initiate a measurement sequence manually \(trial measurement\)](#) to determine a suitable tolerance band.



With the version for switch and haptic testing, MP85A-S, it is not possible to monitor the tolerance band.



Refer also to [EASYteach](#) ().

5.1 Principle procedure



When you first use a new MP85A, the presetting (factory setting) for the tolerance band, the alarm window and the range window corner points are identical, i.e. all windows are on top of each other. The presetting for the corner points is -10/-10 and +10/+10. The alarm window must be larger than the range window and the tolerance band.

Step 1

First go to the [Alarm window](#) tab and click on **Adjust alarm and range windows autom.** The alarm window will be set to the measuring range of the transducer enlarged by 15% in all directions; the range window will be set to the measuring range enlarged by 10%. The Δx and Δy of the data reduction will also be set to practice-oriented values for these ranges.

Step 2

Check the values on the **Alarm window** tab. All measured values must lie within this window. These are, e.g. maximum traverse path or maximum force, etc. as well as the minimum values that could occur as long as the system is operated *correctly*.

Step 3

Check the [Range window](#) tab. The window covers the operating range that is relevant for the measurement, i.e. the range in which the “important” measured values lie. Thereby you can, e.g. distinguish between the starting path with a pressfit operation and the actual measurement, see figure.

Step 4

Make one or more typical [process measurements manually](#).

Step 5

Let the program create a [Tolerance band](#). If necessary, correct the points calculated and then store the settings to the device.

Step 6

Set the Start, Stop and End conditions for the process on the [Control settings](#) tab. Check and, if necessary, correct the [Data reduction](#) settings and the Alarm and Range window settings.





Abb. 34: Example of the application of a range window

5.2 The Configure evaluation parameter window

The first channel is always displayed as the x channel and the second as the y channel in the graph in the **Configure evaluation parameter** and **MEASURE + VISUALIZE** dialogs. The process number and the number of the measuring points acquired (see [Control settings](#)), can be seen on the right-hand side of the line at the top of the window (toolbar). The line immediately above the graph in the dialog window shows the device name (**General settings**), the active parameter set and the workpiece name (**Data storage**), if this was set.

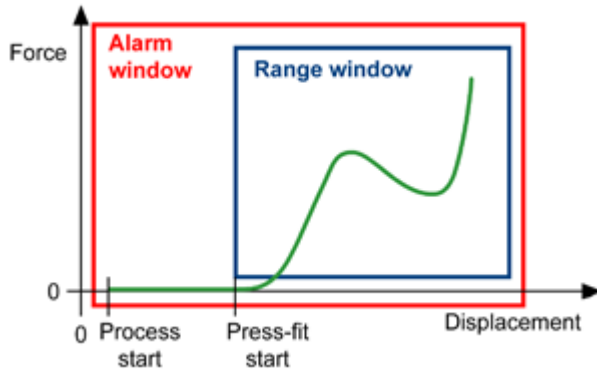
Status messages comprise icons and text and are displayed in the bottom line of the dialog window:

 indicates a fault in the MP85A

 shows that a MultiMediaCard or SD Card has been inserted

 warns that *no* MMC/SD Card is inserted (appears only if **Save to MMC/SD Card** has been activated, see [Save data and results](#))

 is displayed while data or parameters are being saved

If you place the mouse pointer over one of these icons, explanatory text is displayed as a tool tip. Note the status line text messages, also in the main program window, for more explanations.

Graph scaling, zoom



scales the graph so that the largest window or all curves will be displayed (Autoscale everything)



scales the graph to fit into the range window (a margin of 10% will be used)



opens a dialog for manual scaling in which you can also accept the scaling currently displayed

You can at any time zoom in and out within the graph: keep the left-hand mouse key pressed to mark the area you wish to zoom into and select **Zoom** from the context menu. **[Ctrl]-Z** returns to the last display; a maximum of

nine zoom steps are provided. Use  or go to **Graph → Reset zoom** to display the full area (alarm window).

Use **Graph → Graph settings** to display the **Curve with connected points** or superimpose a **Grid**.

5.3 Control settings



First go to the **Alarm window** tab and click on **Adjust alarm and range windows autom.** to get suggested values. The alarm window will be set to the measuring range of the transducer enlarged by 15% in all directions; the range window will be set to the measuring range enlarged by 10%. The Δx and Δy of the data reduction will also be set to practice-oriented values for these ranges.

So that the amount of data is not increased unnecessarily, the number of values to be checked (and saved) is limited: **Data reduction**. You must therefore specify how high the resolution should be for the respective channel. As soon as the current measurement for *either* the x or y channel is larger than the old measurement plus the difference entered, a measured value triple is saved, i.e., the value for *both* channels plus the time value. A maximum of 4000 values are recorded for processing. The measuring is then stopped and a buffer overrun message is issued. The resolution selected can be seen on each curve after a measurement: the measuring points used for the evaluation are also displayed in the graph (**Graph** → **Graph settings** → **Curve with connected points**). After the measurement, the number of actual measuring points acquired will be displayed on the right-hand side of the line at the top of the window (toolbar).



Only saved values will be checked against the tolerance band.



Make a [test measurement](#) and look at the values registered in the graph. If necessary, zoom (hold left-hand mouse key down and drag across the section) to see whether the resolution is sufficient or whether the data reduction values must be reduced.



See also [Data reduction](#), [FAQ: MP85A and PME Assistant](#), Sample rate and filter settings, [Digital inputs](#), [Timing diagrams for different Start/Stop/End conditions](#)

Use the **Control settings** tab to enter the relevant values on the **Start**, **Stop** and **End condition** tabs.

5.3.1 Maximum measuring time

With **Maximum meas. time**, an end criterion must be set. The measurement will end at the latest when this time has elapsed.



If you start a measurement manually, you must either stop it manually () , send an interface command or use the external signal to end the process before the evaluation starts.

The interface commands can be found in the MP85A Operating Manual under “Interface Description CAN/Profibus/Ethernet”.

As a rule, an **End condition** is used to end a process.

5.3.2 Start conditions

The following methods are available to you for starting a process:

1. By an **External start signal** ([start/end event](#))
2. By exceeding/undercutting certain values of a channel (internal start condition, **Start above (below) set point**).

3. Manually via .

4. By an interface command.

You will find the interface commands in the operating manual “Interface Description CAN/PRO-FIBUS/Ethernet” of the MP85A.



No process (no measurement) is started as long as a transducer error is present and the MP85A is not capable of measuring.

The process is also started when you have chosen starting via an external signal or internal condition and one of the two latter events occurs.



No start conditions are apparent with an MP85A with older firmware versions; refer to How do I carry out a firmware update and can the update be prevented?.

5.3.3 Stop conditions

You can stop a process as follows:

1. **Standstill recognition**

If the measured signal changes by less than the value entered during the time specified, the process is treated as finished and the evaluation will begin.

2. **Above/below reference value + time until stop**
(follow-up time)

One or both channels can be checked. Enter the reference value(s) which should be monitored and the time until stop, i.e. the amount of time the measurement should continue once this value has been reached.



The condition is only evaluated if—with **below reference**—the reference value plus hysteresis has been exceeded once or if—with **above reference**—the reference value minus hysteresis has been undercut once. The hysteresis (5% of the range window) is required to ensure that noises or small disturbances in the signal do not cancel the measuring at the time t_x . The percentage entry refers to the respective axis of the range window.

See Example Stop/End condition: below reference value in x channel and Example Stop/End condition: below reference value in y channel

3. **Stop at reverse motion of channel x**

The operation is stopped as soon as the measured value in the x channel is smaller than the Δx entered for the **Data reduction**.

4. External end signal (Stop condition **None**)

A digital input ([Start/End process](#)), for example from an end switch or the PLC, signals the end. This also stops the process.



Only level changes (flanks) are evaluated.

Notes about the Stop conditions

- In cases 1 to 3, the process will also stop (and finish) if you have selected **External start signal** and the level of this signal has again changed (event “End”), if



you click on  or if the corresponding interface command is issued.

You can find the interface commands in the MP85A Operating Manual “Interface Description CAN/Pro-fibus/Ethernet”.

- All Stop conditions are immediately evaluated using the (raw) data. They are not evaluated using the values shown in the graphs which have resulted from the data reduction. A graph may display values at different points in time than those actually used for evaluating a Stop condition.
- If both channels are to be checked, for example, for **Below reference value**, the condition is considered as fulfilled if the signal drops below the set point on one channel while the other lies statically below the reference value. It is not necessary to have a level *change* for the second channel. This also applies when using **Above reference value**: as soon as the condition is met for the first channel, the *level* of the second channel is evaluated. The condition is considered fulfilled if the level is already higher than the specified reference value.

For the *Below limit* condition the hysteresis lies *above* the reference value.



Abb. 35: Example of stop/end condition: Undercutting reference value on x channel

For the *Below limit* condition the hysteresis lies *above* the reference value.

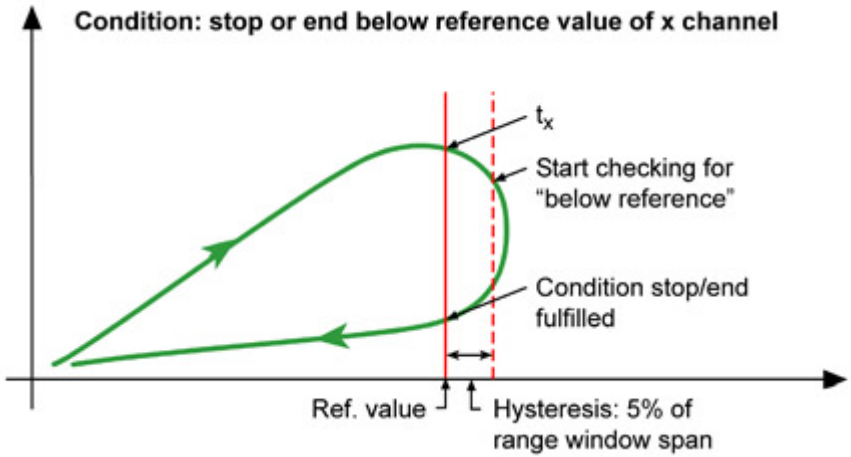

Abb. 36: Example of stop/end condition: undercutting a y channel reference value

5.3.4 End conditions

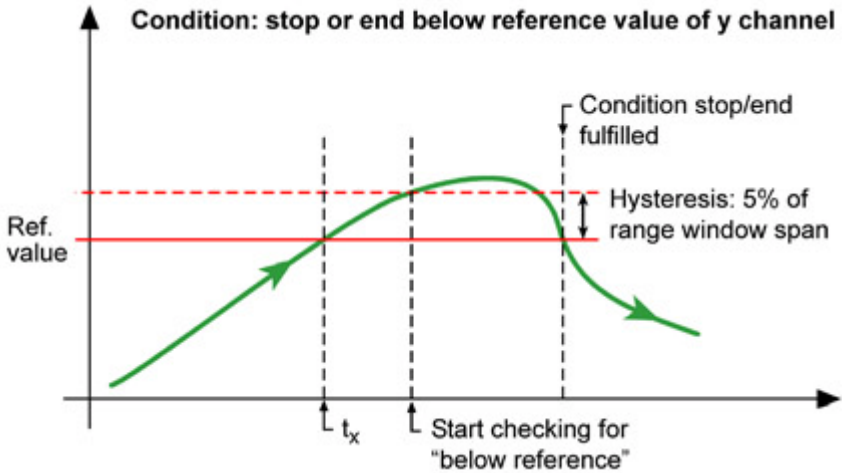

As long as the End condition is not fulfilled, the data in the RAM will not be saved and *no ready message* will be issued, i.e. the *test stand is stopped*.

You can end the measuring of a process as follows:

1. With an external signal ([Start/End process](#)) or manu-

ally via . An interface command works in the same way as the manual control.

You can find the interface commands in the MP85A Operating Manual "Interface Description CAN/Pro-fibus/Ethernet".

The stop and end time points are the same with an external signal as well as with manual control. The two operating modes can also be mixed, i.e. the process will be ended when you either click on the button or the digital “Stop” signal is issued.

2. You can end the measuring when the Start condition has been left again, i.e. you must also start with an (internal) Start condition.

Example: if “above displacement value” is used as Start condition, this means that the displacement value entered for the Start condition must be undercut again, including a hysteresis of 1% of the related axis of the range window.

See Example for leaving the Start condition “Above reference value in x channel” and Example for leaving the Start condition “Above reference value in y channel”

3. With an End condition (internally checked reference value, i.e. measured value of a channel).

 In this case the condition is only evaluated if— with **below reference**—the reference value plus hysteresis has been exceeded once or if—with **above reference**—the reference value minus hysteresis has been undercut once. The hysteresis (5% of the range window) is required so that noises or small disturbances in the signal do not cancel the measuring when the time reaches t_x . The percentage refers to the respective axis of the range window. See Example End condition: below reference value in x channel and Example End condition below reference value in y channel

Notes

- With a process-optimized measurement the ready message is only set if the End conditions are fulfilled *and* the values to be saved are in the RAM. The disadvantage of process-optimized measurement is that with fast running processes it may be that not all processes are saved. If there is no space available in the RAM, the data will be discarded. See also [Storage methods](#)
- With a measurement with no data loss *additionally* enough (older) process data must be transferred from the RAM on to MMC/SD Card or PC so that the values from the next measurement will fit into the memory (RAM). If this is not the case, the system must wait, i.e. the *test stand is stopped*.

For the *Above limit* condition the hysteresis lies *below* the reference value



Abb. 37: Example of a start condition: exceeding an x channel reference value

For the *Above limit* condition the hysteresis lies *below* the reference value.

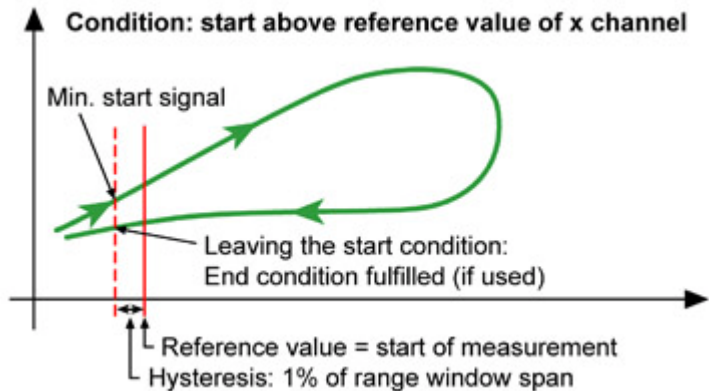

Abb. 38: Example of a start condition: exceeding a y channel reference value

For the *Below limit* condition the hysteresis lies *above* the reference value.

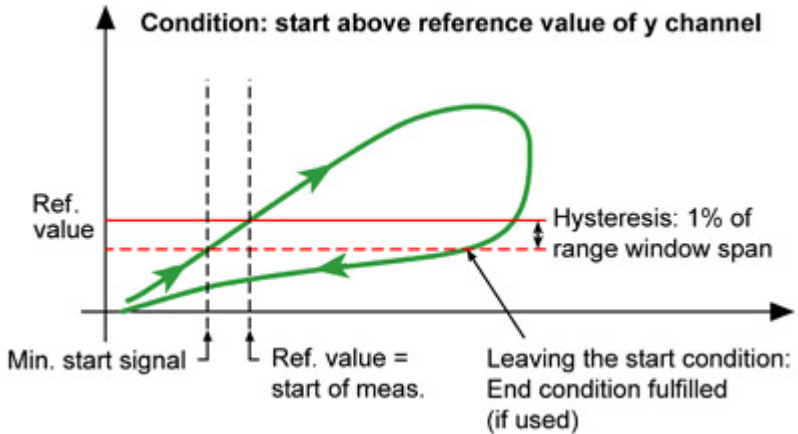

Abb. 39: Example of stop/end condition: Undercutting reference value on x channel

For the *Below limit* condition the hysteresis lies *above* the reference value.

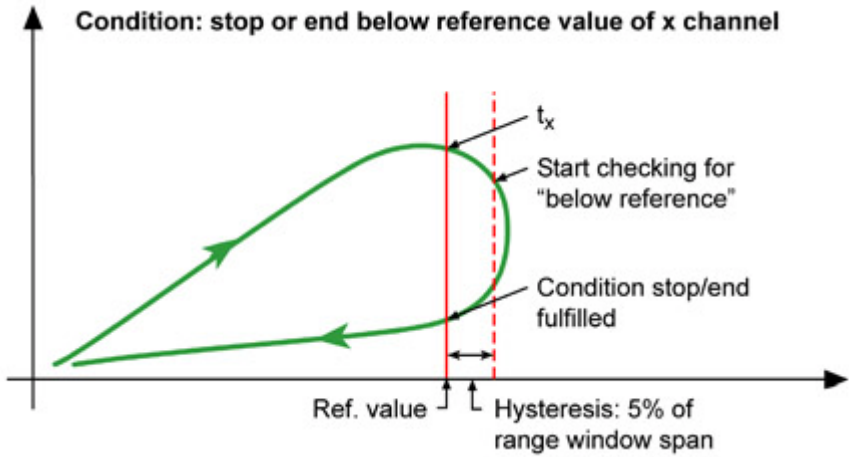

Abb. 40: Example of stop/end condition: undercutting a y channel reference value

5.4 Alarm window



When you first use a new MP85A, the presetting (factory setting) for the tolerance band, the alarm window and the range window corner points are identical, i.e. all windows are on top of each other. The presetting for the corner points is $-10/-10$ and $+10/+10$.

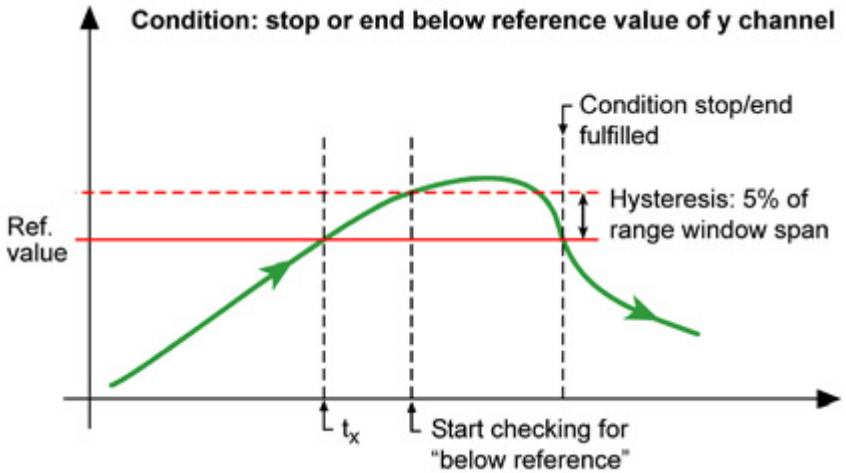

Click on ***Adjust alarm and range windows autom.*** to get suggested values. The alarm window will be set to the measuring range of the transducer enlarged by 15% in all directions; the range window will be set to the measuring range enlarged by 10%. The Δx and Δy of the data reduction will also be set to practice-oriented values for these ranges.

This window is used to monitor the general system status and to protect against overload. You should enter here the limit values (or these values slightly reduced) for the transducer. As soon as measured values lie outside this window, an alarm message is issued and the process is marked as NOK (not OK). The alarm message can be output via the digital outputs or as interface message.



Do not enter 0 as the lower limit if this value could be reached or if a value even slightly lower may occur during *normal* operation. Use instead, for example, a value of -1% of the transducer nominal load.



The alarm window must always be rectangular. Only two corner points can be entered. The alarm window must be larger than the range window and the tolerance band.



See also [Range window](#)

5.5 Range window



When you first use a new MP85A, the presetting (factory setting) for the range window and the alarm window corner points are identical, i.e. both windows are on top of each other. The presetting for the corner points is -10/-10 and +10/+10.



Click on ***Adjust alarm and range windows autom.*** to get suggested values. The alarm window will be set to the measuring range of the transducer enlarged by 15% in all directions; the range window will be set to the measuring range enlarged by 10%. The Δx and Δy of the data reduc-

tion will also be set to practice-oriented values for these ranges.

The range window defines the range which is used to record and evaluate the process.



No values will be recorded outside this window and no check is made with regard to any tolerance window.



The range window must always be rectangular. Only two corner points can be entered. The range window must be smaller than the alarm window.

The range window is of advantage if a part of the values measured during the process is not relevant for the evaluation. In figure 1, for example, the section of the curve before the press-fit process starts (marked red) is relatively large and is not necessary for the current evaluation. In practice, the section marked red is not required for the evaluation and is omitted, see figure 2.



See also [Alarm window](#)



Abb. 41: Example of a process for a range window



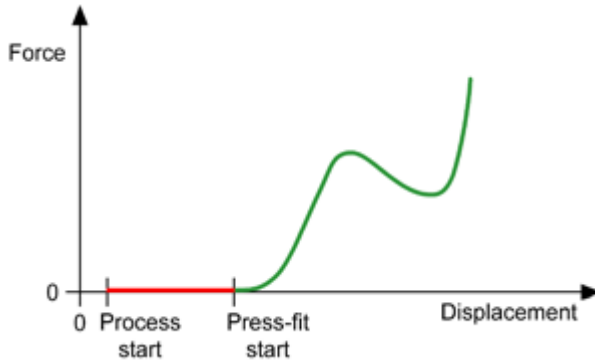

Abb. 42: Example of the application of a range window

5.6 Test measurement (start measurement manually)

There are three possibilities of doing this:

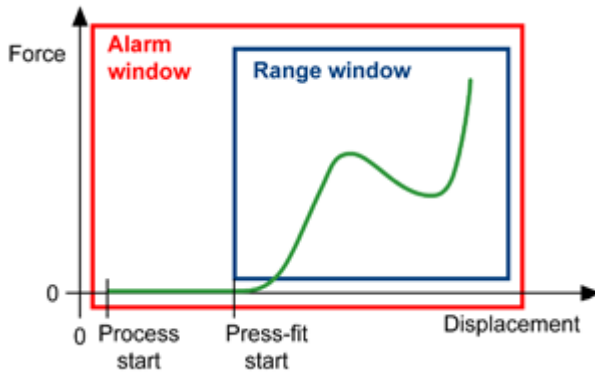
1. **Method 1:** Perform a measurement using Start/End conditions. You may use digital inputs additionally or exclusively. (The measurement starts if either the Start condition applies or the digital start/end input is set.)
2. **Method 2:** Use  (Start process) and  (Stop process) located at the window top.
3. **Method 3:** Use buttons **Start** and **Stop** on the **Tolerance band** tab.

Use the Start and End conditions **External signal** on the **Control settings** tab, without the signals being present.

You can have *only one* measurement in memory for calculating the tolerance band when using methods 1 and 2. With method 3 *several* measurements can be made and you may *select* one as reference for the calculation.



No process (no measurement) is started as long as a transducer error is present and the MP85A is not capable of measuring.

The status of the measurement (measuring or finished) is shown on the left-hand side of the status line at the bottom of the window. Please note that any tolerance band properties may be edited only if a process is ended.



Measuring reference curves also creates statistical values. Therefore deactivate the statistical data handling or delete the statistics after such measuring operations. See [Statistical data handling](#), [3D graph \(MEASURE + VISUALIZE\)](#)



See also [Control settings](#), [Data reduction](#)



5.7 Defining a tolerance band

-  When you first use a new MP85A, the presetting (factory setting) for the tolerance band corner points is $-10/-10$ and $+10/+10$.

Procedure

1. Make one or a few measurements as described in [Test measurement \(start measurement manually\)](#).
The curve measured last is always displayed in red, all others in blue.
2. Set the **Number of base point pairs** and specify the distance in x and y direction for the tolerance band calculation: **Max. offset in x** and **Max. offset in y**.

-  Depending on the method used in step 1, continue with step 3 or step 4.

3. **Methods 1 and 2** (measure with  and , with Start/Stop/End conditions or with external signal):
Click on **Create tolerance band**.

A dialog window appears and asks you whether the curve measured last shall be used as (single) reference curve.

-  With this method only this curve may be used as reference for the calculation. It is not possible to select from several measurements.

4. **Method 3** (measure with **Start** and **Stop**): Choose the curve (**Create a tolerance band around...**) to be used as reference for the calculation.

 You can measure and display up to 10 curves. However the calculation is always done with *one* curve only.

5. Now **Create a tolerance band**. (When using methods 1 or 2 you must click the button again.)

The program uses a vector based algorithm to calculate the specified number of base points. So, for example, for 16 base point pairs 15 values above and 15 values below the curve are calculated. Two additional points are used at the left and right side of the measured curve to “close” the plot. The distance of these points is half the distance of the next two points beside. The calculated curve is not closed to indicate start and end points. However the later evaluation treats the curve as closed.

6. Optimize single points by dragging them with the mouse. In any case we recommend to check the area at the start and end points of the measured curve. It might also be necessary to correct the density of the points derived from the calculation, because the calculation additionally considers the speed of change for the values measured.

 The graph may be zoomed as usual: hold left-hand mouse key down and drag.

7. If you are satisfied with the tolerance band, save the setting to the device with **Apply**.



If you want to exclude part of the measured curve via a range window, the tolerance band should extend beyond this side of the range window. Otherwise the curve will always be evaluated as NOK (not okay).

Notes

- Limit values are taken into account in the process evaluation in addition to the tolerance band if **Use status in total result** is activated, see [Limit values](#).
- Measuring reference curves also creates statistical values. Therefore deactivate the statistical data handling or delete the statistics after such measuring operations.
See [Statistical data handling](#), [3D graph \(MEASURE + VISUALIZE\)](#)



See also [Alarm window](#), [Range window](#), [Test measurement \(start measurement manually\)](#), [Data reduction](#)

6 Monitoring with envelope curve

Generating the envelope curve parameters is only possible with the EASYteach module. When loading parameters generated with this module, this type of monitoring is also set at **PREPARE MEASUREMENT → Evaluation criteria → Define evaluation mode**. The monitoring of an envelope curve only differs from [Monitoring with tolerance band](#) in that the plot with the readings must both enter and exit the envelope curve. With a tolerance band all readings must lie within the band.

You will find further information in the EASYteach Online Help.



In the tolerance band mode only processes can be monitored in which the x values increase in one direction (no outward and return movement).

When monitoring with an envelope curve, no measurement (no process) is started while a transducer error is present and the MP85A therefore cannot take measurements.

Note

- With **Consider status in evaluation** you can take the limit values into account in the process evaluation in addition to the envelope curve; refer to [Limit values](#).
- Measuring reference curves also creates statistical values. Therefore deactivate the statistical data handling or delete the statistics after such measuring operations.

Refer to [Statistical processing, 3D graph](#) (**MEASURE + VISUALIZE**).

 Refer also to [Plus Tools](#).

7 Saving results, data storage

 The settings for data storage are identical for all parameter sets.

You use the **Data storage** menu to set which data is saved and where. During the storage of data the symbol  is displayed in the status line of the dialog window with the graph. Any errors are displayed as text in the status line in the *main window* of the PME Assistant.

During storage initially only temporary files are created (with a tmp file name extension). It is only when all the data have been written to the file that the appropriate file name extension C85 or D85 is written. If you want to process the files with another program, this feature indicates whether all the data have already been written.

You can choose between two storage media: [Internal storage on a MultiMediaCard \(MMC\) or SD Card](#) or [External storage via CAN bus or Ethernet](#), e.g. on the PC.



Since storage takes a different length in time depending on the medium, the data must be temporarily stored in the RAM. The amount of free space still available here *on calling* the window is displayed under **Transfer memory still available internally**. If there is not enough time for storage between the individual measurements, this value becomes increasingly smaller (recall window or use the **Window** → **Update** menu; the display is *not refreshed dynamically*). With periodic processes in which some periods run quickly one after the other before a longer intervening time period, you can use this window to check whether the storage is taking place quickly enough. Otherwise you must reduce the number of values to be stored

or select a different target memory. *Errors* during the storage of data are saved in the `COMLOG.LOG` file. The file is also created in the selected [storage folder](#); if you have not yet selected the storage folder, it is created in the main program folder. The file is deleted at a size of 500 kbytes and created anew.

You can generate a signal via the [digital outputs](#) if

- the size of the transfer memory drops below 16 kbytes (typ. space requirement for a measurement)
- the memory available on the MMC/SD Card drops below 5 Mbytes.



Refer also to [SAVE/LOAD PARAMETERS](#), [Display stored data](#), [Files on MMC/SD Card](#).

With ***Keep device name on parameter load*** you can define that when loading a parameter set the device name is retained, i.e. it is not overwritten by the name saved in the parameter set.



On termination of the program the query appears of whether the current settings should be saved for the next start. If you answer with **Yes**, the current settings are saved to Parameter set 31 in the flash memory.

7.1 Storage medium MultiMediaCard/SD Card (target MMC/SD Card internal)

Measuring curves, measuring results and parameter sets can be saved on the optional MMC/SD Card storage card. Depending on the card you can save a different amount of

values. Approx. 15 kilobytes is required for a measuring curve with e.g. 600 value triplets (two channels plus time). That means approx. 300,000 measuring curves can be saved on a 1 GB card. The card can be removed to read out the data even during a measurement.



If the MMC/SD Card is full and data saving is activated *no ready message* will be issued, i.e. the *test stand is stopped*.

See also Status messages in window [Display current values](#)

Use only standard cards, no high speed cards or other card types like SecureMMC, MMC*plus*TM or MMC*mobile*TM. The rate at which the data is transferred is restricted internally. MMC or SD Cards must use FAT16 format in order to be recognized by the MP85A, no NTFS format. If necessary, re-format your card. To optimize the access times of the MMC/SD Card, the card should be defragmented or re-formatted at regular intervals.



If  is shown in the status line of windows **Measurement curve** or **Configure evaluation parameters**, no MMC/SD Card is available or the card has not been recognized.

The files are always written into the MP85 directory on the MMC/SD Card. The directory will be created if it does not already exist. Also further sub-directories are created if required, see [File names and directories](#).



The number of measuring points acquired is also shown in the windows with measuring curves (graphs).

Procedure for changing the MMC/SD Card

1. Press the **+** key several times until **MMCState** is displayed
2. Press the **SET** key
Remove the MMC/SD Card after the display confirms that the MMC/SD Card has been deactivated: **MMC-State stopped**. Press the MMC/SD Card lightly to release it.
3. Push a new (empty) MMC/SD Card into the slot and press until it clicks into position.

7.2 Storage medium external (storage via CAN bus or Ethernet)

This option is used for transferring the selected data via the interface. In this case the data are normally saved on a PC. Use a Fast Ethernet interface (100 Mbit) for the shortest possible transfer times. Further information can be found in the MP85A Operating Manual.



Data is only saved on the PC if a connection between PC and MP85A exists and one of the programs PME Assistant, EASYmonitor or INDUSTRYmonitor *has been started*. The respective program may however be minimized. The EASYmonitor and INDUSTRYmonitor programs are components of the FASTpress Suite. The user logged on under Windows must have write authorization for the selected directory.

The files are saved to directory DATA which is created as sub-directory to the installation directory of the program PME Assistant. Call the menu **File → Change storage**

directory to enter another directory, see [File names and directories](#).

Notes

- You need the NTFS file system if you record many processes: This could produce more than 65,000 files during one test which will be written into a single directory. This is only possible with a NTFS file system.
- When saving data in the network, we recommend that you use the INDUSTRYmonitor program. This program has been optimized specially for fast data transfer and allows short machine-cycle times.

7.3 Storage methods

You specify your priorities for saving via **Storage methods**:

1. **No data loss**

All data is saved. The RAM is always used first when saving. Then the values are transferred to the PC or MMC/SD Card. The *next* process will *not* start until there is enough free RAM capacity. The digital signal *Ready* will also not be set.



A new measurement or process may start only after all values are transferred, i.e. the test stand is stopped.

See Timing diagram for a measurement with no data loss

2. **Optimized process**

If data is not saved quickly enough on the PC or MMC/SD Card, the last data cannot be stored in the

RAM (no free space) and will be lost. This can be recognized as one or more process numbers will be missing. This always affects the entire data set—both statistical data and the entire curve data.

-  You should use **Optimized process** if you need to monitor very quick processes or the results or curves are only intended for sample checks. See Timing diagram for a process-optimized measurement

7.4 Files to save

-  If you view the measured curves and also the windows (coordinates) or envelope curve or tolerance band later, you must save the results *and* curves.

Save results

In these files the *results* are saved, i.e. the values which are displayed in the evaluation (**MEASURE + VISUALIZE**) under [Results of last measurement](#), the *window coordinates respectively envelope curve or tolerance band* used as well as other data relevant to the process, for example, also the limit results. In the default setting only *one* file is produced and new results are appended to this file. With the option **Create new result file with every process** you can also save the result of each process in a dedicated file. *R85* (R = result) is used as the file name extension.



Files with the R85 file name extension can also be imported into Excel; refer to [File formats](#).



In order that all data can be read into Excel (R85 file name extension), there is a special macro from HBM which imports all data still present after the import into column 256 of the first worksheet to the next (second) worksheet. You will find the macro “LargeDatabaseImport” in the worksheet “MP85A-Excel-Macro_R-files-import” on the system CD in the folder “UTILS\MP85A-ExcelMacro-Import_R-Files”.

Save curves

For each process (process counter) one file is created containing all measurement triples. All curves of successfully completed processes (**OK**) receive the **C85** (C = correct) file name extension; for the **NOK curves** (not in order) **D85** (D = defective) is used.

Number of saved curves

To avoid saving lots of unnecessary data, you can restrict the number of curve files saved on the MMC/SD Card to, say, 1000. In this case the oldest files are deleted. This setting is not taken into account with an **External** target memory.



Refer also to [Retrieve saved data](#), [File names and folders](#), [File formats](#), [Limit values](#).

7.5 File names and directories

The file name will be different depending on the storage target.

- MMC/SD Card: The name comprises the number of the active parameter set (2 characters) and the pro-

cess number (6 characters). The file extension depends on the type of file saved.

With a later transfer of the files to the PC the missing information can be added, so that the same file name is generated as for direct saving on the PC, refer to [Files on MMC/SD Card \(copy to/from PC\)](#).

- PC: The name comprises the workpiece description (if assigned) and two underscores (__). This is followed by the parameter set number (2 characters) and process number (6 characters), an underscore (_) and the CAN ID or the last group of the Ethernet address of the respective MP85A. The file extension depends on the type of file saved.

Example for a results file:

H3KL25__03000001_110.R85 describes the first file created on the PC containing the process results for the workpiece H3KL25 and the device with the ID 110, the settings correspond to parameter set 3.

Specialties when saving on MMC/SD Card

The files are always written into the MP85 directory on the MMC/SD Card. The directory will be created if it does not already exist. For files with extension *C85* and *D85*, a new sub-directory is created for every 500 files. The directory name is comprised of the parameter number and the process number of the first file saved in the directory, e.g. 03000500. An exception is the first directory where 000000 is used as the process number.

Specialties when saving on PC, storage directory

Use **File** → **Change storage directory** to specify the directory on the PC where the files will be saved. If you

wish you can also enter a sub-directory from **PREPARE MEASUREMENT** → **Data storage** and **Subdirectory** or use an interface command. This sub-directory will be created under the storage directory. This option is helpful if e.g. you wish to use separate directories for different workpiece batches. Typically a subdirectory that identifies the object processed is specified through an interface command from the PLC or host computer.

Notes for saving on PC

- You need the NTFS file system if you record many processes: This could produce more than 65,000 files during one test which will be written into a single directory. This is only possible with a NTFS file system.
- The user logged in under Windows must have write authorization for the selected directory.
- Note the restrictions on the use of special characters in file names under Windows. *Do not use “_” (underscore) or “.” (point) as the PME Assistant uses these symbols as identification in file names. It could lead to errors when displaying data from these files.*



See also [Retrieve saved data](#)

7.6 File formats

ASCII and QDAS are available as file formats.

Importing data to Excel

You can also import files with the file extension R85 into Excel. When importing, state that the single values are

separated *with semicolons (;)*. The first lines of the file contain further information about the recorded values: data and time, process number as well as name and units of the channels.



In order that all data can be read into Excel, there is a special macro from HBM which imports all data still present after the import into column 256 of the first worksheet to the next (second) worksheet. You will find the macro “LargeDatabasImport” in the worksheet “MP85A-Excel-Macro_R-files-import” on the system CD in the folder “UTILS\MP85A-ExcelMacro-Import_R-Files”. During the import the numbers for CAN index and sub-index are also converted so that they are easier to find in the tables of the MP85A operating manual in the section Interface description.

Procedure for running the macro

1. Open the worksheet “MP85A”-Excel-Macro_R-files-import” from the system CD.
2. If on opening you receive a security warning that the worksheet contains macros, click on **Activate macros**.

If your system is configured such that you yourself cannot enable macros, contact your administrator who can check the macro and sign it.

3. Using **Extras** → **Macro** → **Macros** call the macro “LargeDatabasImport”.
4. In the subsequent dialog specify the file which you want to import.

The file is imported (to Worksheets 1 and 2) and calculated appropriately. With the numbers for CAN index and subindex you can now interpret the values of

the individual rows in the tables of the operating manual for the interfaces. The values must be interpreted according to the specifications (Float, UINT16, INT32) which are present for the corresponding command. With binary values (bits) counting starts with Bit 0 (least significant bit).

Example

The macro indicates the numbers 2950 and 0006.

1. The first number corresponds to the object index. Therefore, find the (object) index 2950.
2. The second number corresponds to the subindex. Therefore, find the index 2950 for which the subindex is 6.

Result: Process status.

3. The value for this purpose is specified as UINT16. With this specification you can decrypt the values given in this Excel column. The numbers correspond to those in the “Data” column of the operating manual. The number 4 would, for example, correspond to **Stop by ext. hardware**.



Depending on the details in the operating manual, an additional conversion may be needed. A value of -32768 (decimal) for a UINT16 value has to be first converted to a positive value (unsigned): $-32768 + 65536 = 32768$. This produces a binary code of 1000 0000 0000 0000, i.e. only Bit 15 is set.

Manual conversion of the coded details in the R85 files

In order to translate the coded details in the R85 files yourself (without using the macro LargeDatabaseImport),

you must first convert the numbers in the column headers into hexadecimal values and then convert them into two values each of four figures. You can then assign these values to a command using the Interface description section in the MP85A operating manual. The values in the individual rows must be interpreted according to the specifications (Float, UINT16, INT32) which are listed for the corresponding command.



With binary values (bits) counting starts with Bit 0 (least significant bit).

Procedure

1. Convert the number in the column header into a hexadecimal number, for example, using the calculator integrated in Windows.

Example: *693108742* (decimal) gives *29500006* (hex).

2. Divide the number into two numbers each with four figures: *2950* and *0006*
3. The first number corresponds to the object index. In the Interface description section of the operating manual find Object index *2950: Process status*.
4. The second number corresponds to the subindex. Find *006* for the example: *Reason for ending*.
5. The value is specified as UINT16. With this specification you can decrypt the data given in this Excel column. The numbers correspond to those which are stated in the "Data" column of the operating manual, e.g. the number *4* for the example above would correspond to ***Stop by ext. hardware***.

The further procedure corresponds to that explained above.

Example

693108738 (decimal) gives 29500002. This corresponds to the command *Process status* with subindex *Status* (2950 and 2). With this command Bit 12 indicates the status OK with 1 or Bit 13 the status NOK with 1. A numerical value for a process of, for example, 21514 (decimal) gives 101 0100 0000 1010 binary. *Bit 12* is therefore 1 and *Bit 13* is 0. You can therefore either evaluate Bit 12 (1 = OK) or Bit 13 (0 = OK); the process was in order. A value of, for example, 25610 (decimal) corresponds to 110 0100 0000 1010. Here, Bit 12 is not set (0 = NOK) and Bit 13 is set (1 = NOK), i.e. the process was not in order.

7.7 Save statistical data, statistical processing

With **Save statistical data** the statistical data present in the RAM (refer also to [Statistics and classification of tolerance windows](#)) for the 31 parameter sets are saved in the flash EPROM.



For parameter sets, which have been loaded from the PC or MMC/SD Card, no statistical data is determined, i.e. the statistical processing is stopped. Therefore no statistical data can be saved. Therefore, after loading a parameter set from a PC or MMC/SD Card, you should immediately save it (safe from power failure) in the flash EPROM using **Save in flash**.

Saving the statistical data also occurs automatically on switching off the device and – if set – at regular time intervals: **Save statistical data automatically: On**.

Depending on the duration of the process, storage then occurs every ten cycles, but after ten minutes at the earliest.

Statistical processing: Off enables you to stop the OK and NKO counters as well as the statistical processing, e.g. so as not to corrupt the statistical evaluation during a modification of window or tolerance band settings. The setting is only effective with parameter sets from the flash memory; the setting is **Off** in all other cases.

Notes

- Saving the statistical data requires some time, during which any process currently running cannot be monitored. We therefore recommend that this option is only activated for slow processes. Otherwise use a [digital input](#) and the **Save statistics** function to obtain a storage time-point which is favorable for the process.
- For storage on switching off the device the buffer capacitor which provides the power supply for storage must already be charged. Since this is only ensured after about ten minutes after switching on, the data are immediately saved to the flash EPROM in this period after a change.

8 SAVE/LOAD PARAMETERS



If you load a parameter set from the PC or MMC/SD Card, it is initially only written *to the RAM* and activated. Therefore however, the parameter set is not securely saved and the statistical processing is stopped, i.e. *no further statistical evaluation is made*. Consequently, select **Save in flash** and save the settings here in one of the 31 parameter sets.

All settings (system parameters) labeled with * are not overwritten when loading parameter sets (from firmware version 2.30). The system parameter sets include the general settings, interface parameters, passcode and the settings for data storage (and statistics).

On termination of the program the query appears of whether the current settings should be saved for the next start. If you answer with **Yes**, the current settings are saved to Parameter set 31 in the flash memory.

This menu contains several submenus which are described in the following.

Save all settings secure from power supply failure in the flash EPROM of the MP85A

Here, provide a unique name for each parameter set. It is displayed during operation, e.g. in the graphs.

Reload into RAM, i.e. activate, a setting saved in flash EPROM



Here it is also possible to reset all the setting in that you load the factory setting (selection possible before Parameter set 1).

Save the active (RAM) parameter set on the PC

Saves all settings to the PC. Although the system parameters are also saved, they are not activated on loading.

Load any parameter set into the RAM from the PC

-  Follow the information on processing statistics. The windows with the measured curves display for example, [PC: bin] for a binary parameter set from the PC after the parameter set name.

Save the active (RAM) parameter set on the MMC/SD Card

-  Depending on the file format, 31 or 999 parameter sets are available; refer to the information below.

Reload one of the parameter sets from the MMC/SD Card into the RAM

-  Follow the information on processing statistics. The windows with the measured curves display for example, [MMC: bin] for a binary parameter set from the MMC after the parameter set name.

Store the settings and system parameters saved in the flash EPROM on the PC (backup)

In the dialog you can save either all 31 parameter sets in a folder or just individual parameter sets. Each parameter set contains all the settings and system parameters applicable at the time of saving. Also, those settings are saved which apply commonly to all parameter sets.

Restore settings and system parameters saved on the PC to the flash EPROM

In this case all settings *and* the system parameters are restored, i.e. also the settings applicable to all parameter sets.

Notes

- You must quit dialogs by clicking the **OK** or **Cancel** button or by closing the dialogs (corresponds to **Cancel**) to be able to open and edit other dialogs.
- After calling a dialog you can prevent execution at any time by clicking **Cancel**. Selecting a dialog or parameter set does not yet execute any action.
- With the [Signal conditioning](#) you can define whether the zero value is retained during loading or whether the zero value from the parameter set is used.
- With the [Data storage](#) you can define whether the device name is retained during loading or whether the device name from the parameter set is used.
- Some settings (labeled with *) apply to *all* parameter sets: system parameters. Therefore, the setting last saved always applies. If, for example, you initially use the language **German (General settings)** and save your settings in Parameter set 1, then choose the language **English** and—together with other settings—save them in Parameter set 2, then after recalling Parameter set 1 **English** is still set as the language. From firmware version 2.3 the same also applies when saving or loading from the PC or the MMC/SD Card: the system parameters are *not* restored. The system parameters are only also restored with a Restore (**Restore PC -> flash**).

- When loading a parameter set from the PC or MMC/SD Card no statistical data is loaded, i.e. the OK/NOK counter and the statistical processing contain invalid values. *Also no further statistical evaluation occurs*, i.e. the statistical processing is stopped. The statistical processing only re-occurs when you again save the parameter set loaded into RAM to a parameter set in the flash EPROM. Refer also to [Deleting the statistics](#).
- The numbers in the dialogs for the parameter set in the flash EPROM and on the MMC/SD Card do not signify that the parameter sets with the same number are identical or that, for example, Set 12 on the MMC/SD Card is loaded into Set 12 of the flash EPROM. When loading single parameter sets, loading *always only takes place into the RAM*. In both cases you can only save up to 31 different parameter sets in XML format. Use the parameter set names for unambiguous identification.
- Saving a parameter set to the MMC/SD Card or PC can occur in XML format or in binary format. A binary parameter set can be loaded faster later, but only in an MP85A from firmware version 2.12. On an MGCplus you can save up to 31 parameter sets in XML format and up to 999 parameter sets in binary format; on the PC there is no limit. Files in XML format can be read both by an MP85A with any firmware version and also by other programs, e.g. you can evaluate the data via XML and XSLT.
- Parameter sets in XML format can also be loaded via the keypad on the device. The binary parameter sets

can only be loaded via the PME Assistant or an interface command.

 Refer also to [Save results](#), [Data storage](#), [Retrieve saved data](#), [General settings](#) and [File names and folders](#).

9 MEASURE + VISUALIZE

 If the system is protected by a passcode, you can only access the windows under this menu. All other menus except the passcode entry are blocked.

You may activate the **Display current values** window at any time, even while data is being entered. The other windows show only data when at least one measurement has been performed.

 Statistical data can be deleted via the PME Assistant main window menu after the [3D graph](#) has been called.



You can also double click in the Windows Explorer on all result or curve files. This opens the **Retrieve saved data** window and loads and displays the data.



See also [FAQ: MP85A and PME Assistant](#)

9.1 Display current values (measurement display)

This window displays the currently measured values and information about the status of the limit switches (if defined). More icons are shown for transducers with TEDS module, to display the status for the TEDS data and identification. In the lower section you can see the

status of the digital inputs and outputs. Click on  (Status) to display the process and the measuring value status of both channels.

-  The window may remain open during a process run (measurement).

Symbols for the TEDS status

 indicates that a TEDS module has been recognized in the channel.

 indicates that all TEDS settings that could be carried out by the MP85A have been activated. (For example, the “Calibration table” template is not supported as the MP85A can only carry out linear scaling.)

 indicates that not all settings could be activated, see [Using TEDS](#).

 indicates that no TEDS module has been found.

Status information

Status	Meaning
Measuring status	Shows whether an error occurred at the transducer or for amplifier channels x and y. See also Possible error messages and instructions for correction
Transducer test	Shows whether a transducer test has been <i>successfully</i> carried out. See also Transducer test
Limit value 1 ... 4	One of the limit values 1 to 4 is active
Process status, Process status 2	Displays the process run and the result. See also timing diagrams for process-optimized measurement and measurement with no data loss, timing diagrams for different Start/Stop/End conditions

Status	Meaning
MMC/SD Card nearly full	Indicates that the MMC/SD Card should be changed, see Changing the MMC/SD Card . If the MMC/SD Card is full, <i>no ready message</i> is output, i.e. the <i>test stand is stopped</i> .
Int. memory nearly full	Indicates a problem when saving the data. Normally the data is output from the internal memory (RAM) either to the MMC/SD Card or via the interface. If this cannot be carried out or cannot be done fast enough, more and more space is required in the RAM. See also timing diagrams for process-optimized measurement and measurement with no data loss If the memory is full, <i>no ready message</i> is issued, i.e. the <i>test stand is stopped</i> , until there is again enough space available.

9.1.1 Possible error messages and instructions for correction

 The messages in square brackets are shown in the MP85A display.

Message	Reason	What to do
Transducer error [TrnsdErr]	The measuring amplifier in the MP85A is overloaded	Check the transducers connected and the type of connection (sense lines connected?). It is also possible that a displacement transducer is not positioned correctly (core is outside measuring range) or a transducer or cable is faulty.
ADC overflow [ADC Ovf]	The AD converter is overloaded	The problem is similar to that encountered with transducer error. It is also possible that the signal is too high (check the measuring range). See also the individual transducers in section Specify transducer
Gross overflow [Grs Ovf]	The gross value lies outside the measuring range	This can happen, for example, if there are high tare loads. The net value plus the tare load gives the gross value. See Signal conditioning (zero balance, low-pass filter)
Scaling error [Scal.Err]	The scaling is incorrect	Please check the values entered, see Enter transducer characteristic and What limitations apply for (transducer) scaling?

Message	Reason	What to do
EEPROM error	An error has occurred when reading from the EEPROM in the MP85A	This may be a one-time read error. Please repeat the operation. If the fault occurs again, contact the HBM technical support (see PME Assistant Online Help).
Flash Error	An error has occurred when reading from the flash EPROM	This may be a one-time read error. Please repeat the operation. If the fault still exists, please contact the HBM technical support (see PME Assistant Online Help).
CAN bus error	An error has occurred on the CAN bus	Check whether the terminating resistances are available or whether there is a faulty cable. Then switch on the device again. If this does not help, try to isolate the defective device by connecting only one device at a time on the CAN bus.
Internal calibration error [InCalErr]	The factory calibration of the MP85A is faulty	This may be a one-time error. Please re-start the MP85A (switch off and switch on after 30 seconds). If this does not help, contact the HBM technical support (see PME Assistant Online Help).

Message	Reason	What to do
Storage allocation error	The internal RAM has no longer storage space available for the process data	<p>This error occurs if data is either not transferred or not transferred fast enough from the RAM to the storage target.</p> <p>See timing diagrams process-optimized measurement and measurement with no data loss</p> <p>Check whether the status message “MMC/SD Card almost full” is active. In this case, change the MMC/SD Card.</p> <p>See Changing the MMC/SD Card</p> <p>Check whether the status message “Internal memory almost full” is active. In this case the data transfer is not fast enough. Either reduce the amount of data to be transferred or change the storage target.</p>
MMC/SD Card defective [!]	The MMC/SD Card could not be recognized	<p>Check whether the card is of the proper type (standard MMC) and formatted with FAT16, if you have inserted a new card.</p> <p>See Storage medium MultiMediaCard/SD Card</p>



See also [Status information](#), [Display current values \(measurement and status display\)](#), [What do the LEDs on the MP85A mean?](#), [Timing diagrams for different Start/Stop/End conditions](#)

9.1.2 What limitations apply for (transducer) scaling?

The scaling can go from 1/30 of the measuring range for 1,000,000 digits resolution up to 10 digits resolution for the entire measuring range.

Let's assume, 2 mV/V is set as measuring range. Then 0.066 mV/V can be set as minimum scaling on 1,000,000 steps, i.e. 30,000,000 for the full measuring range. The decimal positions are included in this number. If 50,000 is entered for 50 kN nominal load, this will therefore create a resolution of 50,000 steps.

When using as counter or with SSI transducers, the scaling can amount to between 20 digits for an impulse (1:20) and 10.000 impulses per displayed digit (10,000:1).

9.2 Measurement curve

The last process (measurement) is displayed in a graph together with the tolerance windows. The display corresponds to the top section of the [Configure evaluation criteria](#) window.

The graph displays always the first channel as the x channel and the second as the y channel. The top x axis displays relative coordinates (see [x channel relative to](#)), if a reference point has been entered for one of the tolerance windows. Relative coordinates can *only* be used for windows which are to be evaluated *after* the measurement has ended.

You will see the process number and the number of measuring points acquired (see [Control settings](#)) on the right-hand side of the top line in the window (toolbar). The line

immediately above the graph in the dialog window shows the device name (**General settings**) and the active parameter set (number, name and origin, if the parameter set was loaded from PC or MMC/SD Card and has not been saved to the flash EPROM). If set, you will find the workpiece description (**Data storage**) on the right-hand side in the same line.

Status messages comprise icons and text and are displayed in the bottom line of the dialog window:



indicates a fault in the MP85A



shows that a MultiMediaCard or PC Card (MMC/SD Card) has been inserted



warns that *no* MMC/SD Card is inserted (appears only if **Save to MMC/SD Card** has been activated, see [Save data and results](#))



is displayed while data or parameters are being saved

If you place the mouse pointer over one of these icons, explanatory text is displayed as a tool tip. Note the status line text messages, also in the main program window, for more explanations.

See also [Status information](#)

Graph scaling, zoom



scales the graph so that the largest window or all curves will be displayed (Autoscale everything)



scales the graph to fit into the range window (a margin of 10% will be used)



opens a dialog for manual scaling in which you can also accept the scaling currently displayed

You can at any time zoom in and out within the graph: keep the left-hand mouse key pressed to mark the area you wish to zoom into and select **Zoom** from the context menu. **[Ctrl]-Z** returns to the last display; a maximum of nine zoom steps are provided. Use  or go to **Graph → Reset zoom** to display the full area (alarm window).

Use **Graph → Graph settings** to display the **Curve with connected points** or superimpose a **Grid**.



Use **Graph → Curve history mode** to display up to five successive measured curves simultaneously. These may be used for comparison purposes, see [Curve history mode](#).

If you want to display data or results *stored in a file*, use [Retrieve saved data](#).

Curve history mode



Use **Graph → Curve history mode** to display up to five successive measured curves simultaneously. These may be used for comparison purposes. The current curve is displayed in red, all others in gray.

After the menu point has been activated, use  to delete all displayed curves.

Presentation differences in relative windows

When using relative windows, only two modes can be used for display:

1. Only in absolute co-ordinates, i.e. without relative win-

dows (  ). This display is active when **Curve history mode** is activated for the first time.

2. Only with relative windows, i.e. without absolute co-

ordinates (  ).

Absolute display

All relative windows are hidden, the absolute axis is displayed in the graph. The curves are in fact evaluated with the defined relative window, but the graph display is absolute. The curves usually shift towards each other, thus making it difficult to assess the development of the curve (example 1: Windows 1 and 2 are relative and therefore hidden, Window 3 is absolute and contains the reference points, here the **End positions**). However, you can read the absolute measured values of the individual curves e.g. on the x-axis.

Relative display

All absolute windows are hidden, only the relative axis is shown in the graph. The curve is evaluated and displayed after the measurement. You may display several successive measured curves.



After the second measurement the absolute display is *no longer significant*: curves already measured are moved, so that the respective reference points of the curves fall on the reference point of the current curve (example 2). Therefore the history curves are hidden in the absolute

display. However, the history curves are not deleted and you may toggle at any time between absolute display (current curve) and relative display (with history).



Abb. 43: Differences with relative windows: Example 1



Abb. 44: Differences with relative windows: Example 2

9.3 Results of the last measurement

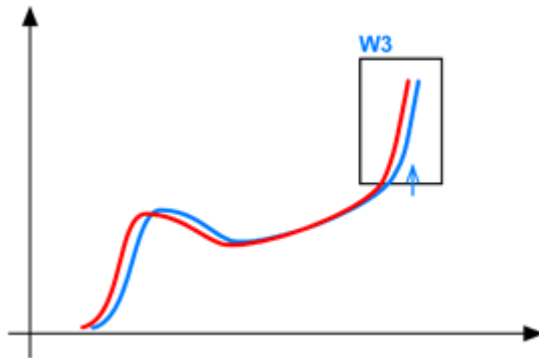
In evaluation mode **Tolerance window** results and status of the last measurement as well as all values from the *evaluation* are displayed, e.g. the values for x and y when the curve enters the respective tolerance window. These values will be processed in the [Statistics](#) evaluation. Additional values are displayed with the switch and haptic test (MP85A-S only).

In evaluation mode **Tolerance band** or **Envelope curve** the **Overall result OK** or **NOK** (not okay) is displayed besides general information like process and parameter set number and minimum/maximum values for both channels.

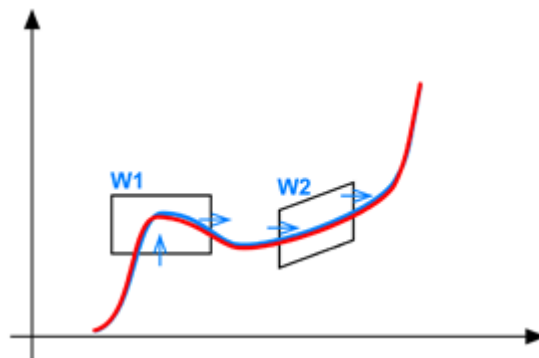
- Process number: internal counter (process counter) which counts up to 999,999 and then begins again at 1. The number is also included in the file name, see [File names and directories](#).
- Parameter set number: specifies which MP85A [Parameter set](#) was used when the measurement was carried out.
- If you have activated **Use status in total result** for the [Limit values](#) the limit results (red/green LEDs) are also displayed.
- Only MP85A-S with [switch testing](#): the symbols ∇ and Δ show the switching time points. In addition, the digital input used and the switch status are displayed, e.g. I1:1 for switch closed on digital input 1.
- Only MP85A-S with [haptic test](#): the haptic characteristic data to be tested are displayed under the values for the other windows in the table. If there is an error, the related characteristic will be shown, e.g. “actuation

force error". If a digital input was assigned, the switching time points are also displayed.

Notes

- Use **auto refresh** to refresh the display automatically if a new measurement has been made. Use  to refresh manually.
- Example for the values in the columns displayed: **Min(Channel y)** shows which minimum value (**y**) has occurred in the y-channel (the name assigned under [Specify transducer](#) is shown here) and the corresponding value in the x channel (**x**).



See also [Evaluation of tolerance windows](#), [Statistics and distribution \(tolerance windows\)](#), [Statistics](#)

9.4 Statistics



For parameter sets, which have been loaded from the PC or MMC/SD Card, no statistical data is determined, i.e. the statistical processing is stopped. Therefore no statistical data can be saved. Therefore, after loading a parameter set from a PC or MMC/SD Card, you should immediately save it (safe from power failure) in the flash EPROM using **Save in flash**.

The two windows available under Statistics are used for the display of the statistical data obtained during the measurements, i.e. the process results (refer also to [Statistics and classification of tolerance windows](#)). The statistical

data are written to the flash EPROM when the power supply is switched off.



Using  you can refresh the display if a new measurement has occurred in the meantime.



When using **tolerance band** or **envelope curve** as the evaluation mode, no classification is available. With tolerance windows which form the mean no statistical data is calculated. With a switch test (only MP85A-S), in addition **No switching process** is displayed when the switch has not changed its state or **Switch process repeated** if multiple switching has taken place.



Refer also to [Statistics and classification of tolerance windows](#), [Retrieve saved data](#), [Save statistical data](#), [Switch test](#).

9.4.1 3D graph

The 3D graph shows for all parameter sets and tolerance windows, a tolerance band or an envelope curve the number of processes which

- were evaluated as OK
- were evaluated as NOK (not okay)
- were measured

This allows you to see at a glance which tolerance windows and parameter sets were used successfully and which processes were evaluated as not correct.

If a particularly large number of processes were NOK for a parameter set and a particular tolerance window, perhaps the window was not defined correctly. In the [Distribution \(bin counting\)](#) window, you can display the minimum and maximum values measured for each process with this parameter set and this window. You can then check whether the process was in general widely spread or whether the values lie on the top or bottom edge of the tolerance window.

Options menu, clear statistics

Use the **Options** menu, available after calling up the graph window, to

- delete the statistics for *all* parameter sets and additionally the OK/NOK counters
- delete the statistics for the *current* parameter set and additionally the OK/NOK counters
- reset the process counter (process number). In this case the OK/NOK counters are *not* reset.



Resetting the process counter also influences the [file name](#). Backup old files if necessary as the counting restarts with 1 after a reset.

Use **Statistical data handling: Disabled** to stop the OK/NOK counters and the statistical evaluation, see [Save statistical data, statistical data handling](#).

9.4.2 Distribution (bin counting)

This window is used for “detailed evaluation”. You can display statistical data for a certain parameter set and toler-

ance window: The data determined for the tolerance window, e.g. ***y-max*** and ***y-min*** for each process, is divided into classes, the frequency of the classes is counted (totaled) and displayed as histogram.

The data which should be displayed must be defined for the respective tolerance windows in the evaluation matrix, see [example](#) and [Statistics and distribution](#).

As the mean value and standard deviation of all classes are also calculated in this window, you can estimate how much the individual processes differ or how uniform they are.



If most values lie on the top or bottom (or left and right) limits of the window, check whether the process runs as required. If not, change the tolerance window slightly and save the settings as a new parameter set. Then perform several measurements and check the modifications via the statistics window.



In evaluation mode ***Tolerance band*** or ***Envelope curve*** no distribution (bin counting) is calculated. No statistical data is calculated when a tolerance window is used to check for mean values.



See also [3D graph](#) (Clear statistics)

9.5 Retrieve saved data

In the window **Retrieve saved data** you can reload and display files which have been produced using **Data storage** and *saved on the PC*. As required, copy the [files from the MMC/SD Card to the PC](#). Use this window too for

printing process logs; the printout is optimized for printer pages and displayed in the print preview.



You can integrate your company logo in the display and the printout. To do this, place the file with your logo into the installation folder of the PME Assistant under the name LOGO.BMP or LOGO.GIF (bitmap or GIF format). The logo is then shown under the overall result.



Procedure

1. Using the menu **Graph** → **Curve history**, define how many curves you would like to see in the graph (maximum 100). The process data (windows and results) are only displayed for the current curve (marked in red in the graph), i.e. for the last selected process.
2. In the **Select file** window, which is simultaneously open, specify which files are to be displayed. The window (use  if the window has been closed) enables you to specify search criteria such as file type, time period or device address. If you do not require the workpiece designation, leave the field clear. The search for a workpiece designation also finds all terms *beginning* with the entered text, e.g. the search for “NT” also finds “nt125”, “NTa83”, etc.
3. Click on **Find** so that the files found are shown in the list.
4. Depending on which data you have saved, you can load from the displayed files by simply clicking:
 - Process data, i.e. window coordinates or envelope curve or tolerance band and statistical data, if you have selected **Save results** (*.R85) in **Data storage**.

- The measured traces (curves), i.e. only the curve without window coordinates, if you have selected **Save curves** (*.C85 or *.D85) in **Data storage**.

If both file types are present in the same folder, the curves are displayed automatically when you select a file with process data (*.R85). If you activate **Automatically find and display the corresponding windows+results on selecting a curve**, this also occurs on selecting a file with curves, i.e. the measured traces.

5. You display further curves (if present) of a process

using the buttons  and . The setting in **Curve history** determines how many curves can be seen simultaneously in the graph.

In the table the relevant coordinates are given which have been reached in the window at the minimum and maximum of the y channel. Under **Min(y)** there are the x and y coordinates at which the y minimum was reached and under **Max(y)** there are the x and y coordinates at which the y maximum was reached. If you have activated **Consider status in evaluation** for the [limit values](#), the limit results are also displayed (red/green LEDs).

MP85A-S

- During a switch test **No switching process** or **Switching process repeated** are also displayed. During a haptic test the results of the haptic parameters to be tested are also displayed.
- In the table the window type (haptic or switch, i.e. switch test) is displayed after the window name. During a switch test the switching coordinates are dis-

played instead of min/max, i.e. the coordinates at which the switch has changed its state. During a haptic test the data of the haptic parameters to be tested are also displayed in the table below the values for the other windows.

Notes

- You can also load and display all results and curve files present on the PC with a double click.
- In order that all data can be read into Excel (R85 file name extension), there is a special macro from HBM which imports all data still present after the import into column 256 of the first worksheet to the next (second) worksheet. You will find the macro “LargeDatabaseImport” in the worksheet “MP85A-Excel-Macro_R-files-import” on the system CD in the folder “UTILS\MP85A-ExcelMacro-Import_R-Files”.
- When using **tolerance band** or **envelope curve** as the evaluation mode, no classification is available.







Refer also to [Save results, Data storage](#) and [Files to be saved](#).

9.6 Files on MMC/SD Card (copy to/from PC)



MMC/SD Card must be selected as **Target memory** under **PREPARE MEASUREMENT** → **Data storage**, otherwise the data on the MMC/SD Card will not be displayed.

From this dialog window, you can copy files from the PC to the MMC/SD Card, e.g. parameter sets, or files from the MMC/SD Card to the PC without having to remove the

MMC/SD Card. Press  and  to select several files just as you would in Windows. Then click on  or  to transfer the files you have selected. Double click on a directory to open it. To leave a sub-directory, click on the two points (first entry).

When copying the data, the date and time will be read from the file and used as creation date and time for the file on the PC, i.e. in the Windows Explorer the original time when the file was created on the MMC/SD Card will be shown in the **Created** column.

Add device address and workpiece description to PC file name: The CAN ID or the last group of the Ethernet address of the respective MP85A and the workpiece description (if assigned) is added to the file name. This leads to the same file names as if saving directly on the PC, see also [File names and directories](#).

The dialog provides also a button to delete (marked) files on the MMC/SD Card.

How are files saved on the MMC/SD Card?

When files are saved on the MMC/SD Card, they are written into the MP85 sub-directory on the MMC/SD Card. If the directory does not exist, it will be created. When copying files with the extensions *C85* and *D85*, every 500 files a new sub-directory under the MP85 directory will be created. The directory name comprises the parameter set and the process number of the first file, e.g. 03000500. An exception is the first directory where 000000 is used as the process number. Also copy the files from these directories into the same directory as the R85 files (if available), so that [Retrieve saved data](#) can display all existing data.

10 Plus tools

The Plus tools of the FASTpress Suite provide you with the modules EASYsetup and EASYteach which can be called 25 times for testing purposes.

EASYsetup



The **Plus tools** → **EASYsetup** dialog window is password-protected. You can specify your password when you first start this program module.



You also need a password to run the test version, which you can start 24 times. If you then wish to continue using the program module, you will need a license number. After the profile has been set up, the test version will display a note concerning the missing license when the PME Assistant is started. Enter your license number via **Help** → **Program info**.

In this dialog window, specify which menus and dialogs the end user can access, i.e. which branch of the tree will be displayed in the left-hand area of the window of the PME Assistant. This setting is in addition to the [Passcode](#). Only the defined menu entries will be displayed here as long as the current passcode status allows this.



You can define a new password at any time (**Modify**). However, do not forget to save this password, as you will have to send the device to HBM to be reset if you forget it. Use **Save to file** or **Load from file** if you wish to use different profiles (activation settings). Click on **Activate profile** if you wish to use a different profile.

EASYteach

The EASYteach module helps you to evaluate measuring processes, prepare or optimize tolerance window settings or create an envelope curve. You can load as many measured curves as you wish; the mean value of all curves will be calculated automatically.

Depending on the operating mode you can then

- Display statistics windows (Min/Max or standard deviation)
- Generate tolerance windows
- Optimize existing tolerance windows with the help of the loaded curves
- Create an envelope curve (this function is *only* available from the EASYteach module, the PME Assistant itself can only create a tolerance band)
- Check the created or existing tolerance windows against other measured curves



You can work with EASYteach and the PME Assistant at the same time, even if you call EASYteach from the Assistant. In this way you can collect other curves with the PME assistant and load them immediately into EASYteach. However the **Configure evaluation parameter** window may *not be active* when calling, otherwise the PME Assistant will be blocked as long as EASYteach is still running.

Further information can be found in the EASYteach Online Help.

11 Options

11.1 Change log

This option helps you to follow configuration changes that are carried out via this PC and by the (Windows) user currently logged on. Other connections are not monitored. After being activated, all modifications are entered in coded form (internal parameter IDs) in file ChangeLog.LOG. The file is saved in the [Storage directory](#).

To deactivate the log you must enter the password assigned when the log was activated.

11.2 Display connection loss detection

This option ensures that you are informed of any interface problems: **System events** message window. By default all events are written and saved in the file COMLOG.LOG in the [Storage directory](#). With this option you also see a window in which the corresponding message is displayed.



If a connection to the device is interrupted, the PME Assistant tries approx. every five seconds to reconnect the device.

12 FAQ: Questions and answers about MP85A and PME Assistant

- ☞ The times in the flow diagrams of this section are displayed distorted for a better overview, i.e. they are not in the original scale; the levels apply to positive switching logic.

12.1 How do I adjust the interface on the MP85A?

Ethernet interface

Parameterization can only be carried out *manually*; in the PME Assistant the parameters for the interface are only displayed. The PME Assistant software must not be connected to the MP85A over this interface during configuration.

On the MP85A enter the Ethernet address (IP address) and the subnet mask. Operation with dynamic addresses (DHCP) is not possible. You should clarify with your network administrator which IP address (Ethernet address) and subnet mask you have to set. If you only want to establish a direct link between a PC and the MP85A, you can use any address, e.g. 192.168.169.xxx. The last group of three figures (xxx) must be a number between 1 and 254 and different for the PC and the MP85A. Make sure in this case that your PC can switch over the Ethernet connection to a direct link or use a "crossover cable" (not a normal Ethernet cable).

Setting the address and subnet mask on the MP85A:

1. Press the **SET** key for *at least two seconds*.
The display **CAN BUS** appears.
2. Press the **+** key until **ETHERNET** appears in the display.
3. Press the **SET** key.
The MAC address is displayed.
4. Press the **+** key so that the first group of the IP address appears.
5. Press **SET** to be able to change the value with **+** or **-**.
Otherwise press **+** to proceed to the next group.
6. If you have changed a number, press the **SET** key.
7. After the display of the IP address you come to the display of the subnet mask. Change this according to your requirements.
8. To save the changes press the **SET** key for at least two seconds.
The flashing display **Save?** appears.
9. Confirm it by pressing **SET**.
In the second line a flashing double arrow and the text **Yes** appear.
10. Confirm this query also by pressing **SET**.

CAN bus interface

You can only change most parameters *manually*; the PME Assistant software must not be connected to the MP85A over this interface during configuration. Terminate the program if necessary.

-  You do not need to terminate or close the online help when you terminate the PME Assistant software.

Setting the baud rate on the MP85A

1. Press the **SET** key for *at least two seconds*.
The display **CAN BUS** appears.
2. Press the **SET** key again.
The **baud rate** display appears together with the currently set value.
3. Press the **SET** key once again.
A flashing double arrow appears on the left in front of the display of the current baud rate.
4. Press the **+** or **-** keys to change the value.
5. When the desired figure appears in the display, press the **SET** key.
6. Now press the **SET** key for at least two seconds.
The flashing **Save?** display appears.
7. Confirm it by pressing **SET**.
In the second line a flashing double arrow and the text **Yes** appear.
8. Confirm this query also by pressing **SET**.

PROFIBUS interface (only with MP85ADP)

In the PME Assistant only the PROFIBUS address can be set. All other PROFIBUS system parameterization is carried out via appropriate software from other manufacturers, e.g. PROFIBUS software from Siemens.

12.2 How do I set the IP address on my PC?

Procedure with Windows 10

1. Open, for example using the  symbol in the notification area of the taskbar, the **Network and Sharing Center**.
2. In the area **View active networks** click on the intended link (usually **LAN Connection**).
3. Click on **Properties** and specify an administrator account or confirm the confirmation query.
4. Mark **Internet Protocol Version 4 (TCP/IPv4)** and click on **Properties**.
5. Activate **Use the following IP address** and enter an address with which the first three groups of numbers match the groups of numbers of the HBM device and only the last group of numbers contains a different number between 1 and 254. The last group of numbers must not match the one on the HBM device.
6. At the subnet mask enter the same groups of numbers as they are present on the HBM device.
7. Then close all open dialogs by clicking on **OK** or **Close**.

Example:

The IP address of the HBM device is 192.168.169.80 and that of the subnet mask is 255.255.255.0.

Enter **192.168.169.123** as the IP address and **255.255.255.0** as the subnet mask on the PC.

Procedure with Windows 8/8.1

1. Using the **Charms** menu in the Windows desktop (not in the tiles view) call **Settings** → **Control Panel** →

Network and Sharing Center (Display: *Small icons*) or Display network status and tasks (Display: *Categories*).

2. In the area **View active networks** click on the intended link (usually **LAN Connection**).
3. Click on **Properties** and specify an administrator account or confirm the confirmation query.
4. Mark **Internet Protocol Version 4 (TCP/IPv4)** and click on **Properties**.
5. Activate **Use the following IP address** and enter an address with which the first three groups of numbers match the groups of numbers of the HBM device and only the last group of numbers contains a different number between 1 and 254. The last group of numbers must not match the one on the HBM device.
6. At the subnet mask enter the same groups of numbers as they are present on the HBM device.
7. Then close all open dialogs by clicking on **OK** or **Close**.

Example:

The IP address of the HBM device is 192.168.169.80 and that of the subnet mask is 255.255.255.0.

Enter **192.168.169.123** as the IP address and **255.255.255.0** as the subnet mask on the PC.

Procedure for Windows Vista and Windows 7.

1. Using the Windows Start Menu call **Control Panel** → **Network and Sharing Center**. Then **View status** for the intended link (Windows Vista). In Windows 7 click on your **LAN link** to view the status.

2. Click on **Properties** and specify an administrator account or confirm the confirmation query.
3. Mark **Internet Protocol Version 4 (TCP/IPv4)** and click on **Properties**.
4. Activate **Use the following IP address** and enter an address with which the first three groups of numbers match the groups of numbers of the HBM device and only the last group of numbers contains a different number between 1 and 254. The last group of numbers must not match the one on the HBM device.
5. At the **subnet mask** enter the same groups of numbers as they are present on the HBM device.
6. Then close all open dialogs by clicking on **OK** or **Close**.

Example:

The IP address of the HBM device is 192.168.169.80 and that of the subnet mask is 255.255.255.0.

Enter **192.168.169.123** as the IP address and **255.255.255.0** as the subnet mask on the PC.

Procedure with Windows XP

1. Using the Windows Start Menu call **Settings** → **Network Connections**. Via the context menu (right click) call the **Properties** of the intended LAN link.
2. Mark the **Internet protocol (TCP/IP)** and click on **Properties**.
3. Activate **Use the following IP address** and enter an address with which the first three groups of numbers match the groups of numbers of the HBM device and only the last group of numbers contains a different

number between 1 and 254. The last group of numbers must not match the one on the HBM device.

4. At the **subnet mask** enter the same groups of numbers as they are present on the HBM device.
5. Then close all open dialogs by clicking on **OK**. You may have to restart the PC to activate the setting.

Example:

The IP address of the HBM device is 192.168.169.80 and that of the subnet mask is 255.255.255.0.

Enter **192.168.169.123** as the IP address and **255.255.255.0** as the subnet mask on the PC.

12.3 How do I connect the PME Assistant to the MP85A?



The interface must be installed and configured.

Procedure

1. Switch on the power to the PME module(s).
2. Connect the PC-interface with the PME module(s).
3. Start the PME Assistant.
4. Enter the interface used.

CAN bus: If necessary, select the CAN network to be used (**Change**).

Ethernet (MP85A only): If you do not wish to search through all segment addresses (all addresses that have a field with a yellow background) with **Scan**, you can enter the individual IP addresses and insert these in the list of available devices. Each time you click on **Insert IP to device list** the address will be checked to

see whether a PME module can be found. If not, no entry will be made in the device list.

5. Start the **Scan** by clicking on the button to start the interface query which determines the addresses occupied.
6. Call the configuration program from **Start**.

All devices of the PME family found at the interface (**Devices** frame) are displayed in the tree on the left-hand side of the program window. Click on an address to select this device for setup.

Notes

- If you receive the message “This software version is not fully compatible to the device firmware”, you should update the PME Assistant from the Internet.
- MP85A only: If you wish to connect a device via the Ethernet interface and there is already another connection with the MP85A via this interface, you may disconnect this only if you confirm the new connection by entering the number shown in the dialog. This ensures that the first MP85A connection cannot be disconnected unintentionally: After your PC has been connected *no further data* will be sent to the *first* connection, i.e. the PLC or other PC originally connected.

12.4 How do I recognize the file system on my PC and which should I use?

Call the **Properties** context menu in the main folder of the hard disk (e.g. c:\). The third entry in the following dialog (**General** tab) shows the file system used.

You need the NTFS file system if you record many processes. In this case, during a check more than 65,000 files may exist on the PC which requires NTFS.

See also [File names and directories](#)



If your PC does not use a NTFS file system yet, we recommend that you change this. The PC supplier normally provides a conversion program, which will allow you to convert your file system to NTFS without having to re-format your hard disk. Otherwise try to start CONVERT.EXE (located in the Windows subdirectory SYSTEM32) with parameters `c: /fs:ntfs`, if you wish to convert drive c: (`CONVERT.EXE c: /fs:ntfs`). The conversion will take place without loss of data. However, you should make a backup copy of your hard disk for security reasons.

12.5 How do the options in the start window of the PME Assistant work?

Refresh the tree of the settings window (see [Start window of PME Assistant](#)) is deactivated as default in order to display the window more quickly. The program assumes that no settings have been changed in the device. If you have changed a setting manually in the device or if you have worked in **Offline** mode, all settings must be reread, i.e. you must **activate Refresh the tree of the settings window**.



If you activate **Automatically open settings window**, the settings window will open up automatically 5 seconds after the program starts.

Automatically load all dialogs last time used: All windows and dialogs will have the same size and be in the same position as they were when the program was last closed.

To start the program automatically with Windows, create a link to the program (PMEAssist.exe) in the Autostart folder of Windows. Deactivate ***Refresh the tree of the settings window*** and activate ***Automatically open settings window*** and ***Automatically load all dialogs last time used***. The program will then start the next time Windows starts and all program windows that were open at the last time will also be re-opened.

You may also specify a window collection file (**File → Save window collection**) as start parameter: create a link to the PME Assistant and specify the file name including the full path as parameter behind PMEAS-SIST.EXE. All windows will then be re-opened on starting the program.

The PME Assistant start window.

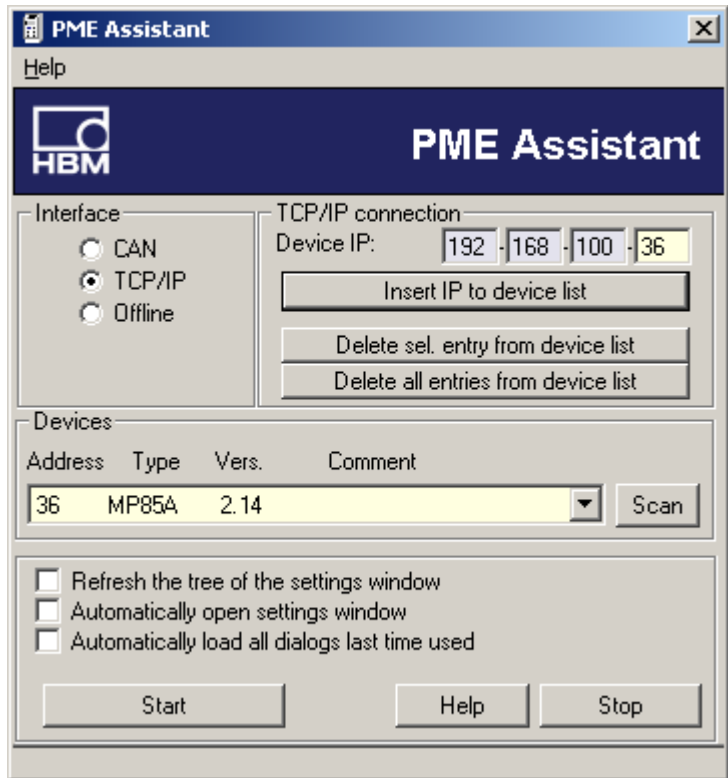

12.6 What happens when connecting additionally to an existing Ethernet connection?

If you wish to connect via the Ethernet interface and there is already another connection active via this interface with the MP85A, you must first disconnect this connection and allow the new connection by entering and confirming the

number shown in the dialog. This ensures that the device cannot be unintentionally disconnected.



By connecting with your PC the *other connection is disconnected*, i.e. the other connection (PLC, other PC) will *not receive any further data*.

12.7 Requirements for MMC/SD Cards

The following applies to the MMC/SD Card for plugging into the MP85A:

- Only standard MMC/SD Cards are admissible; no SecureMMC, MMC*plus*[™], MMC*mobile*[™], SDHC (SD High Capacity) or SDXC Cards (SD eXtended Capacity).
- The maximum admissible size of a memory card is 2 GByte.
- The card must be formatted with the FAT16 file system. FAT32, NTFS or other formats are not admissible.

If necessary, reformat your card: under Windows select **Format** in the context menu for the data medium and as **File system** use the setting **FAT (Standard)**.



To optimize the MMC/SD Card access times, you should defragment or reformat the card at regular intervals.

12.8 How are the sample rate and filter settings connected?

Depending on the filter used, a certain (internal) sample rate is used initially, see table.

Low-pass filter	Internal sample rate (in samples per second)
0.05 Hz	1.15
0.1 Hz	2.3
0.2 Hz	4.6
0.5 Hz	17
1 Hz	37.5
2 Hz	75
5 Hz	150
10 Hz	300
20 Hz	600
50 Hz	1200
≥ 100 Hz	2400



SSI transducers are always recorded at a rate of 1200 values per second

12.9 What does the data reduction do and how do I set it up?

In order not to unnecessarily increase the amount of data generated, the number of values to be checked (and possibly saved) is limited: **Data reduction**. Here, you define

how high the resolution of the relevant channel is to be. When the current measurement *either* for the x channel or for the y channel is greater than the old measurement plus the specified difference, a measurement triple is stored, that is the values for *both* channels and the time value. Consequently, the *resolution* of your measurements in the x and y directions is always at least as good as stated here.



You should acquire at least 200 to 500 measured points to facilitate correct evaluation.

Only these values are checked also with regard to the *range window*, *tolerance band* respectively the *envelope curve*, or the *tolerance windows*. The *alarm windows*, *start*, *stop* and *end conditions* as well as the *external inputs* are *immediately* checked and evaluated on the pitch defined by the *sample rate*. With transducers with the SSI interface however the measurement is always read out 1200 times per second by the MP85A in response to an acceptance signal sent to the transducers. One advantage is that measurements can be taken with a high internal sample rate and an excellent time-axis resolution, because only the *relevant* values need to be processed further (thereby consuming time). In total the MP85A can record up to 4000 values for further processing. If the measurement is then still not finished, it is stopped and the buffer overflow error message is output.

As a test, carry out a sample measurement "manually" to see the current resolution: the measured points used for the evaluation are also displayed in the graph (**Graph** → **Graph settings** → **Plot with connected points**). The number of measured points actually used is displayed

after the measurement in the row right at the top in the window (toolbar) on the right-hand side. Therefore, you can assess whether the number of the recorded measured points is high enough, i.e. whether the resolution is fine enough for the evaluation. Refer also to the examples below.



As an alternative you can click on ***Automatically adjust alarm and range window*** on the **Alarm window** tab. The Δx and Δy of the data reduction will also be set to practice-oriented values for these ranges. Furthermore, the alarm window is set to the measuring range of the transducer enlarged by 15% in all directions and the range window to a range enlarged by 10%.

The number of measurements in the x direction displayed in the following picture is not sufficient to obtain the *exact* trace of the plot if this is required. Here you must reduce the values entered on the register card **Control settings** for the differences in the x or y direction.

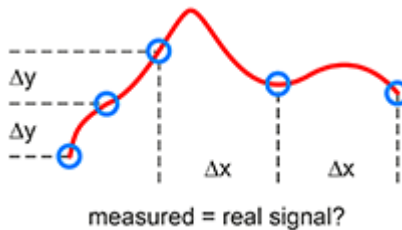

If you acquire too few measured points, the specified windows or the envelope curve may not be evaluated as expected.

Examples of too few measured points (Δx or Δy too large)

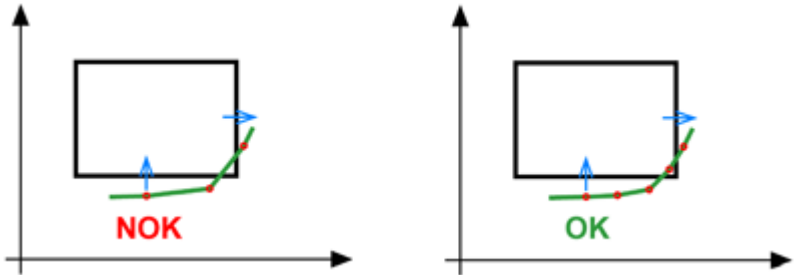

The graph on the left leads you to think the result is OK. However the process is assessed as NOK: Since no measured point lies within the window, there is neither an entry nor an exit and the result is NOK. Increase the number of measurements by reducing the Δx and/or Δy . If then – for the same plot – at least one measurement lies within the window, the result is assessed as OK (picture on the right).

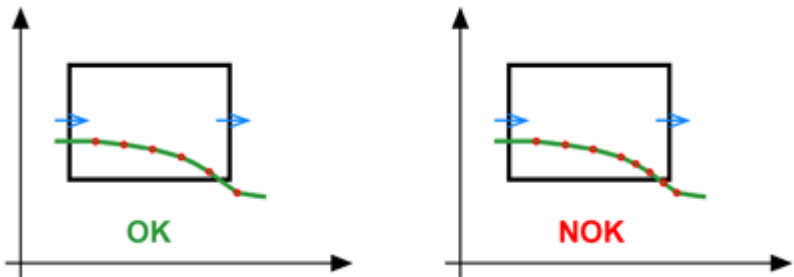

The graph on the left leads you to think the result is NOK. However, the process is evaluated as OK. The penultimate drawn measured point lies within the window (OK). The last drawn measured point already lies to the right

outside of the window, so that the y coordinate is no longer relevant. Increase the number of measurements by, for example, by reducing Δy (picture on the right). Then the exit at the lower edge is detected (the y value is already too low before the right edge of the window).



The graphs do not necessarily display the actual measurements evaluated for the *start or stop condition*. The values plotted in the graphs are the measurement triples arising due to the data reduction, but the start and stop conditions are immediately evaluated with the acquired (raw) data.

12.10 What possibilities are there to start, stop and end the measurement?





As long as the End condition is not fulfilled, the data in the RAM will not be saved and *no ready message* is output, i.e. the *test stand is stopped*.

Different sequences and output signals occur in the MP85A, from “Process started” to “Process ready” to “Result valid” depending on which Start, Stop or End conditions you use. You can see the possibilities and the resulting signals in the following. The time the ready message is issued which is the possible start of the next process is labeled in the timing diagrams as “Ready signal may be issued”: The time then remaining depends on the method that you select for the saving the data: process-optimized (diagram) or with no data loss (diagram).

Start/end with external signal, manually or with interface commands

You use an external signal ([digital inputs](#)) to start and stop

the process or you do this manually with  and . Interface commands have the same function and work like manual controls.

See timing diagram a

Notes

- Stop and end time points are identical with both an external signal and with manual control. Both operating types can be mixed, i.e. the process is started when you click on the button or when the digital “Start” signal is received. The same also applies for the end of a process.
 - ☞ Only level changes (flanks) of the external signal are evaluated.
- If you use a manual start, you cannot end the process with a condition. You must stop it manually, use an external signal or an interface command.

Start with external signal, stop with condition, end with external signal

You use an external signal ([digital inputs](#)) to start and end the process. The measuring shall stop when a certain condition is fulfilled, e.g. when a value is undercut.

See timing diagram b

Notes

- The process will be ended immediately without waiting for your Stop condition if the external signal

goes to “End”, you click on  or the corresponding interface command is issued.

- Only level changes (flanks) of the external signal are evaluated.

Start with external signal, stop and end with conditions

You use an external signal ([digital inputs](#)) to start the process. The measuring shall stop and end when certain conditions are fulfilled, e.g. when a value is undercut. See timing diagram c

Notes

- The process will be ended immediately without waiting for your Stop or End conditions if the external signal goes to “End”, you click on  or the corresponding interface command is issued.
- The Stop and End conditions are only evaluated if— with **below reference**—the reference value plus hysteresis has been exceeded once or if—with **above reference**—the reference value minus hysteresis has been undercut once. The hysteresis (5% of the range window) is required so that noises or small disturbances in the signal do not cancel the measuring when the time reaches t_x . The percentage refers to the respective axis of the range window. See Example: Stop/End condition for undercutting reference value x channel and Example: Stop/End condition for undercutting reference value y channel

Start/stop/end with conditions

Different conditions may be used to start, stop and end the process, e.g. start when a value is exceeded, stop and end when a value is undercut.

See timing diagram d

Notes

- The process will be ended immediately without waiting for your Stop or End conditions if you click on  or the corresponding interface command is issued.
- The conditions are only evaluated if—with **below reference**—the reference value plus hysteresis has been exceeded once or if—with **above reference**—the reference value minus hysteresis has been undercut once. The hysteresis for the Start condition is 1%, for the Stop condition 5% of the range window. The percentage refers to the respective axis of the range window. The hysteresis for the Stop condition is necessary so that noises or small disturbances in the signal cannot cancel the measuring at the time t_x . See Example: Start condition for exceeding reference value x channel, Example: Start condition for exceeding reference value y channel, Example: Stop/End condition for undercutting reference value x channel and Example: Stop/End condition for undercutting reference value y channel

Start/stop with conditions, end with external signal

Different conditions may be used to start and stop the process, e.g. start when a value is exceeded, stop when a

value is undercut. The end is determined by an external signal ([digital inputs](#)).
See timing diagram e

Notes

- The process will be ended immediately without waiting for your Stop condition if the external signal goes to “End”, you click on  or the corresponding interface command is issued.
 - ☞ Only level changes (flanks) of the external signal are evaluated.
- The conditions are only evaluated if—with **below reference**—the reference value plus hysteresis has been exceeded once or if—with **above reference**—the reference value minus hysteresis has been undercut once. The hysteresis for the Start condition is 1%, for the Stop condition 5% of the range window. The percentage refers to the respective axis of the range window. Therefore, make sure that you enter a reference value for the Start condition that is well above or below the Start condition (idle state) of your signal (minimum start signal) to make sure that the process is not started if small disturbances occur in the signal. The point when the Start condition is left shown in the examples is not relevant here. The hysteresis for the Stop condition is necessary so that noises or small disturbances in the signal cannot cancel the measuring at the time t_x .
See Example: Start condition for exceeding reference value x channel, Example: Start condition for exceeding reference value y channel, Example: Stop/End condition for undercutting reference value x

channel and Example: Stop/End condition for undercutting reference value y channel

Start/stop with conditions, end when leaving the Start condition

Different conditions may be used to start and stop the process, e.g. start when a value is exceeded, stop when a value is undercut. The *end* of the measuring is reached when this Start condition is no longer valid, i.e. when “Start when value is exceeded” is used, this value including the hysteresis of 1% for the Start condition is undercut again.

See timing diagram f and for the start and end of the measuring with “Leave Start condition” see Example: Start condition for exceeding reference value x channel and Example: Start condition for exceeding reference value y channel

Notes

- The process will be ended immediately without waiting for your Stop condition if you click on  or the corresponding interface command is issued.
- The conditions are only evaluated if—with **below reference**—the reference value plus hysteresis has been exceeded once or if—with **above reference**—the reference value minus hysteresis has been undercut once. The hysteresis for the Start condition is 1%, for the Stop condition 5% of the range window. The percentage refers to the respective axis of the range window. Therefore, make sure that you enter a reference value for the Start condition that is well above or below the Start condition (idle state) of your

signal (minimum start signal) to make sure that the process is not started if small disturbances occur in the signal. The hysteresis for the Stop condition is necessary so that noises or small disturbances cannot cancel the measuring at the time t_x .

See Example: Stop/End condition for undercutting reference value x channel and Example: Stop/End condition for undercutting reference value y channel as well as the links above for the Start condition.

a) Start/end with external signal or manually



Abb. 45: Flow diagram a) for start/end conditions

b) Start with external signal, stop with (internal) condition, end with external signal

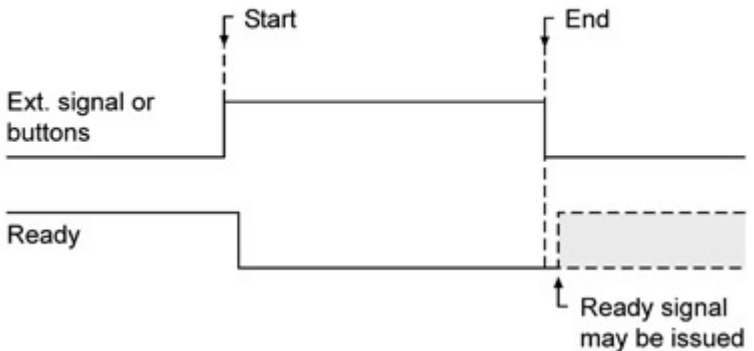

Abb. 46: Flow diagram b) for start/stop/end conditions

c) Start with external signal, stop with (internal) condition, end with (internal) condition

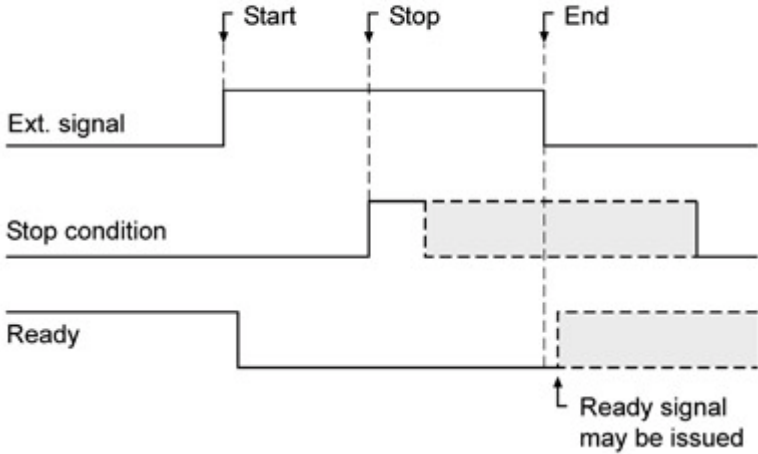

Abb. 47: Flow diagram c) for start/stop/end conditions

d) Start with (internal) condition, stop with (internal) condition, end with (internal) condition

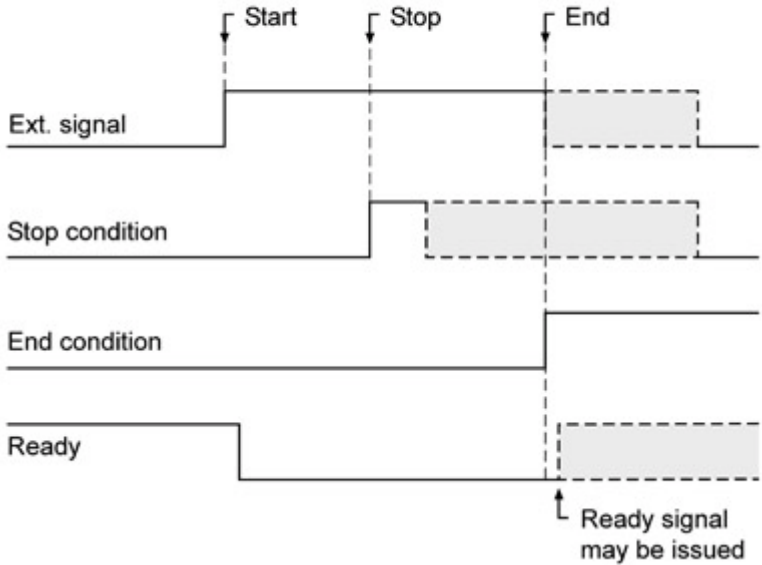

Abb. 48: Flow diagram d) for start/stop/end conditions

e) Start with (internal) condition, stop with (internal) condition, end with external signal

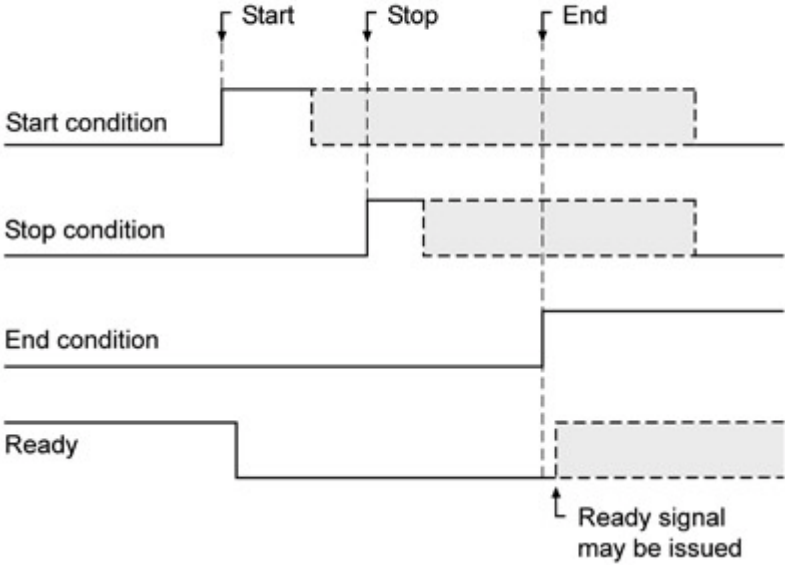

Abb. 49: Flow diagram e) for start/stop/end conditions

f) Start with (internal) condition, stop with (internal) condition, end when "leaving start condition"

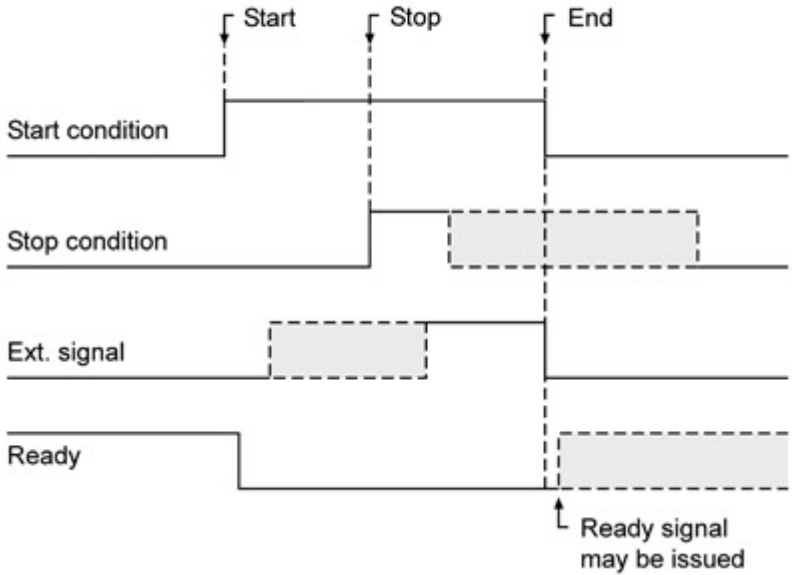

Abb. 50: Flow diagram f) for start/stop/end conditions

For the *Above limit* condition the hysteresis lies *below* the reference value

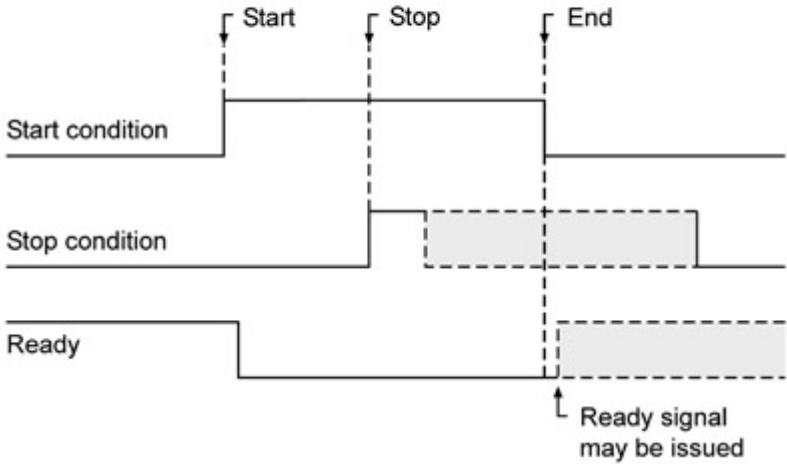

Abb. 51: Example of a start condition: exceeding an x channel reference value

For the *Above limit* condition the hysteresis lies *below* the reference value.

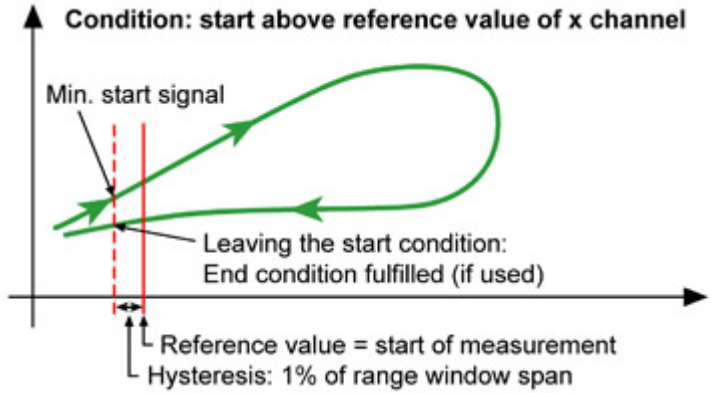

Abb. 52: Example of a start condition: exceeding a y channel reference value

For the *Below limit* condition the hysteresis lies *above* the reference value.

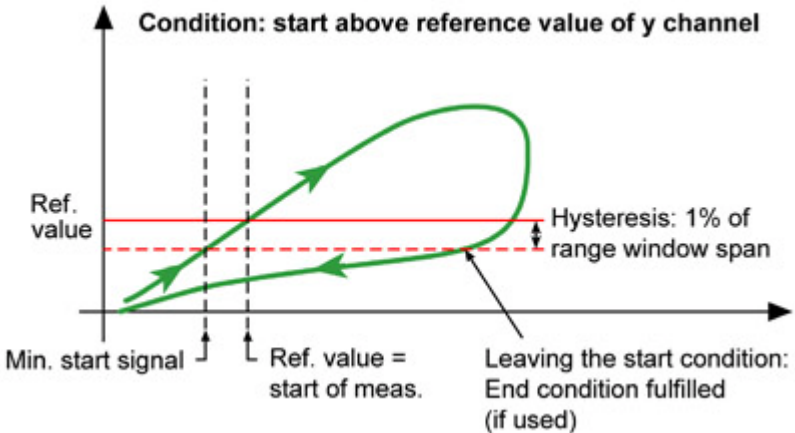

Abb. 53: Example of stop/end condition: Undercutting reference value on x channel

For the *Below limit* condition the hysteresis lies *above* the reference value.

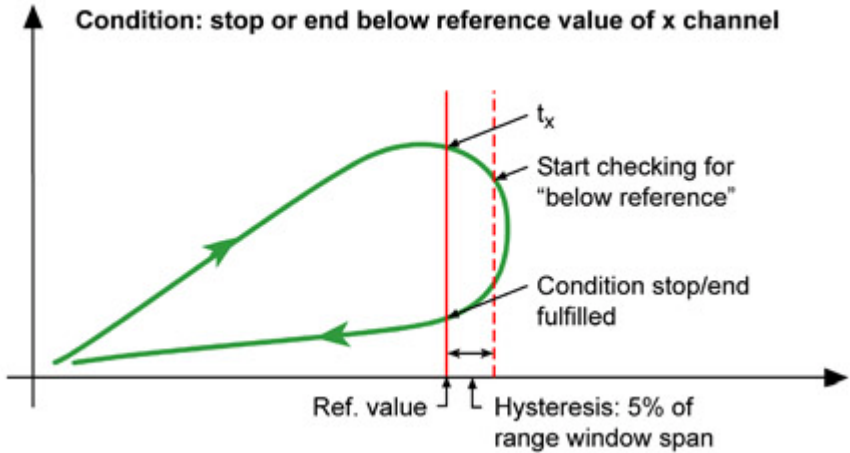

Abb. 54: Example of stop/end condition: undercutting a y channel reference value

12.11 How do I work when setting up the evaluation criteria?

In the test or set up phase of a system where often only a few sample pieces are available, it is particularly helpful if the initial information about the actual process characteristics can be acquired beforehand. Proceed as follows:

1. Deactivate the statistical data handling and thus the OK/NOK counters so that the statistical evaluation is not falsified
See [Statistical data handling](#)
2. Start and stop the process monitoring manually
See [Test measurement \(tolerance window\)](#) and [Test measurement \(tolerance band\)](#)

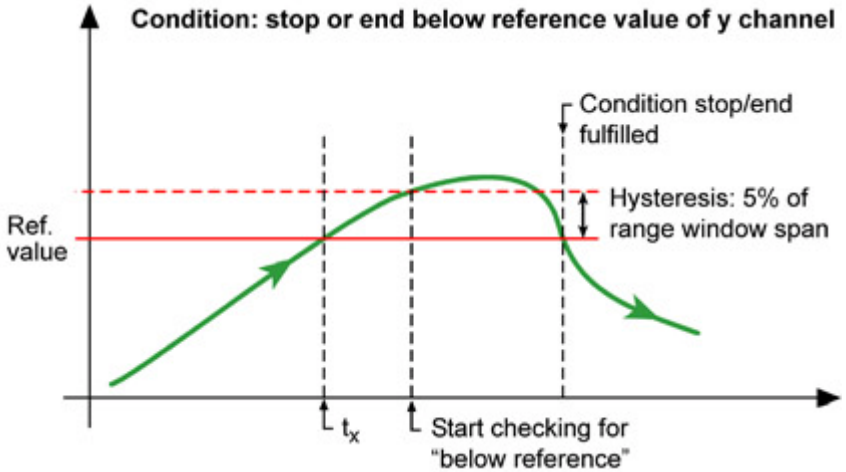
3. Measure several curves
Tolerance window: Display several process curves (**Graph** → **Curve history**) to determine the tolerance windows
Tolerance band: Generate the tolerance band automatically from one of the measured curves
See [Tolerance band](#)
4. Print a protocol of the process curves and evaluation parameters for the documentation.
See [How do I print out a protocol of the process?](#)
 - ☞ EASYteach from the FASTpress Suite provides a range of special methods for process evaluations and documentation.
See [EASYteach](#)
5. Save all process and evaluation parameters permanently in a parameter set in the flash EPROM of the MP85A (data will not be lost if there is a power failure), on the (optional) MMC/SD Card or on your PC.
See [SAVE/LOAD PARAMETERS](#)
6. Create several “Samples” (initial batch) and check the selected parameters.

12.12 What needs to be considered when zero balancing and how long does it take?

With low filter cut-off frequencies the filter settling time must be allowed to pass *before* the zero balance. A pulse of at least 5 ms duration is required on the digital input for

the zero balance. The zero balance terminates a further 5 ms later.

Refer also to [Signal conditioning \(zero balance\)](#).

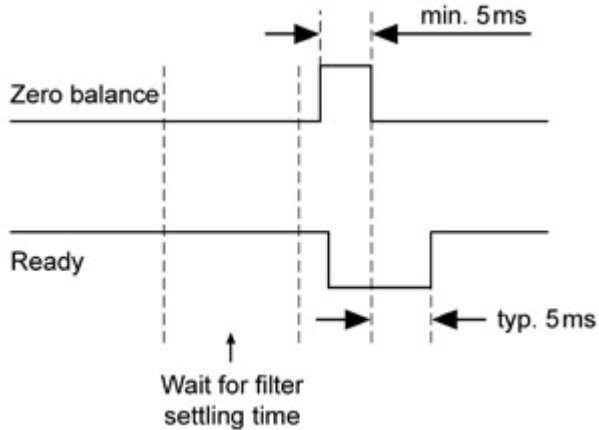

- ☞ Only level *changes*, i.e. *edges*, are evaluated on the digital inputs.

12.13 What is the procedure for a transducer test and what needs to be considered?

With low filter cut-off frequencies the filter settling time must be allowed to pass *before* the test. A pulse of at least 5 ms duration is required on the digital input for the transducer test. The result is obtained typically a further 10 ms later.

Refer also to [Transducer test](#) for the functioning principle.

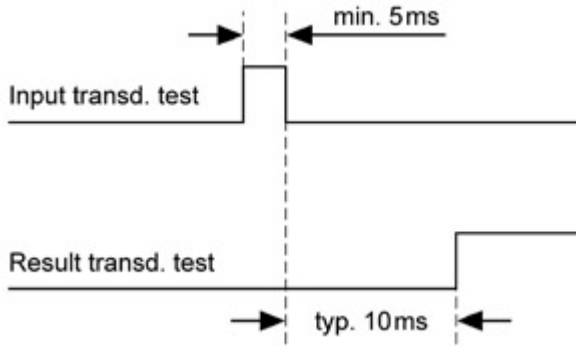

- ☞ Only level *changes*, i.e. *edges*, are evaluated on the digital inputs.

12.14 What limitations apply for (transducer) scaling?

The scaling can go from 1/30 of the measuring range for 1,000,000 digits resolution up to 10 digits resolution for the entire measuring range.

Let's assume, 2 mV/V is set as measuring range. Then 0.066 mV/V can be set as minimum scaling on 1,000,000 steps, i.e. 30,000,000 for the full measuring range. The decimal positions are included in this number. If 50,000 is entered for 50 kN nominal load, this will therefore create a resolution of 50,000 steps.

When using as counter or with SSI transducers, the scaling can amount to between 20 digits for an impulse (1:20) and 10.000 impulses per displayed digit (10,000:1).

12.15 What has to be considered with parameter set switching?

Typically less than 200 ms are needed to activate a new parameter set. With very low filter cut-off frequencies the filter settling time must be *added*. If you are using digital inputs for switching, the switching occurs with a *change* of level on the input (edge).

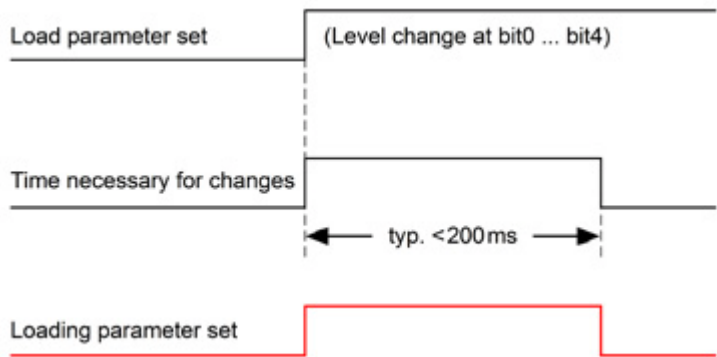

Note

- Only level *changes*, i.e. *edges*, are evaluated on the digital inputs.
- The switching must be terminated before you can start a new process. As a check, use the signal "Loading parameter set". Refer also to [Digital outputs](#).

12.16 How to determine changes to the device settings?

Using the menu **Options** → **Modification log**, you can track the configuration changes which take place via this PC and the currently logged-in (Windows) user. Once activated, all changes are logged in coded form (internal parameter IDs) in the file ChangeLog.LOG. The file is created in the [storage directory](#).

To deactivate logging you have to enter the password assigned during activation.

12.17 Which error messages exist for the measuring/the process status and how can I correct errors?

 The messages in square brackets are shown in the MP85A display.

Message	Reason	What to do
Transducer error [TrnsdErr]	The measuring amplifier in the MP85A is overloaded	Check the transducers connected and the type of connection (sense lines connected?). It is also possible that a displacement transducer is not positioned correctly (core is outside measuring range) or a transducer or cable is faulty.
ADC overflow [ADC Ovfl]	The AD converter is overloaded	The problem is similar to that encountered with transducer error. It is also possible that the signal is too high (check the measuring range). See also the individual transducers in section Specify transducer

Message	Reason	What to do
Gross overflow [Grs Ovfl]	The gross value lies outside the measuring range	This can happen, for example, if there are high tare loads. The net value plus the tare load gives the gross value. See Signal conditioning (zero balance, low-pass filter)
Scaling error [Scal.Err]	The scaling is incorrect	Please check the values entered, see Enter transducer characteristic and What limitations apply for (transducer) scaling?
EEPROM error	An error has occurred when reading from the EEPROM in the MP85A	This may be a one-time read error. Please repeat the operation. If the fault occurs again, contact the HBM technical support (see PME Assistant Online Help).
Flash Error	An error has occurred when reading from the flash EPROM	This may be a one-time read error. Please repeat the operation. If the fault still exists, please contact the HBM technical support (see PME Assistant Online Help).
CAN bus error	An error has occurred on the CAN bus	Check whether the terminating resistances are available or whether there is a faulty cable. Then switch on the device again. If this does not help, try to isolate the defective device by connecting only one device at a time on the CAN bus.
Internal calibration error [InCalErr]	The factory calibration of the MP85A is faulty	This may be a one-time error. Please restart the MP85A (switch off and switch on after 30 seconds). If this does not help, contact the HBM technical support (see PME Assistant Online Help).

Message	Reason	What to do
Storage allocation error	The internal RAM has no longer storage space available for the process data	This error occurs if data is either not transferred or not transferred fast enough from the RAM to the storage target. See timing diagrams process-optimized measurement and measurement with no data loss Check whether the status message “MMC/SD Card almost full” is active. In this case, change the MMC/SD Card. See Changing the MMC/SD Card Check whether the status message “Internal memory almost full” is active. In this case the data transfer is not fast enough. Either reduce the amount of data to be transferred or change the storage target.
MMC/SD Card defective [!]	The MMC/SD Card could not be recognized	Check whether the card is of the proper type (standard MMC) and formatted with FAT16, if you have inserted a new card. See Storage medium MultiMediaCard/SD Card



See also [Status information](#), [Display current values \(measurement and status display\)](#), [What do the LEDs on the MP85A mean?](#), [Timing diagrams for different Start/Stop/End conditions](#)

12.18 What do the error messages with tolerance window violation mean?

With an infringement of the specified entry and exit sides of a tolerance window there are several possible error messages. To simplify the classification of the error mes-

sages, you will find possible (incorrect) plot progressions in the following illustrations with examples.

Entry condition not fulfilled

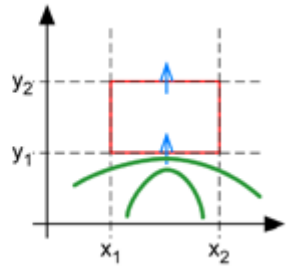
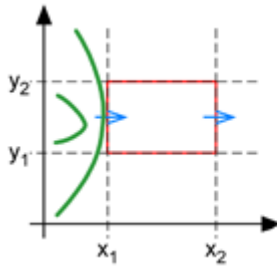

Exit condition not fulfilled

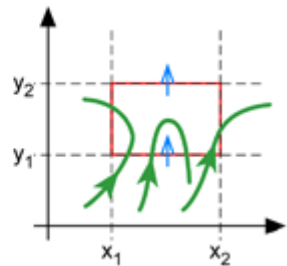
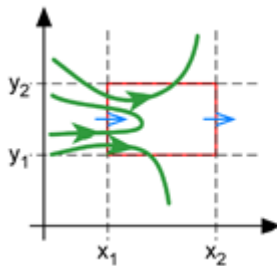

Exit condition fulfilled before entry condition

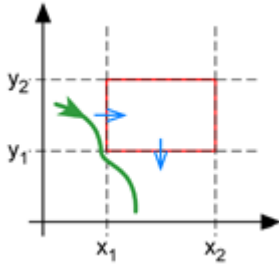

Error Min. x (x too small)

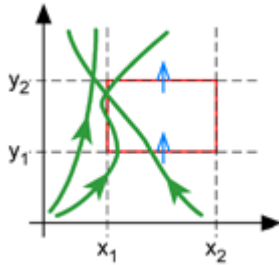

Error Max. x (x too large)

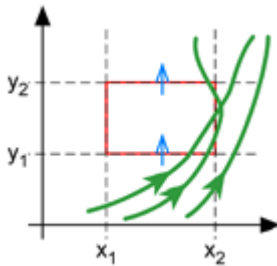

Error Min. y (y too small)

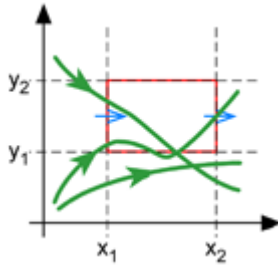

Error Max. y (y too large)

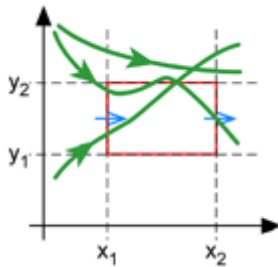

Switching process repeated (only for MP85A-S and switch testing)

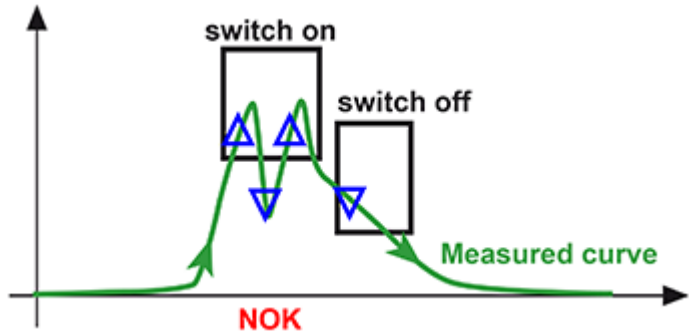

No switching process or an unexpected switching process (only for MP85A-S and switch testing)

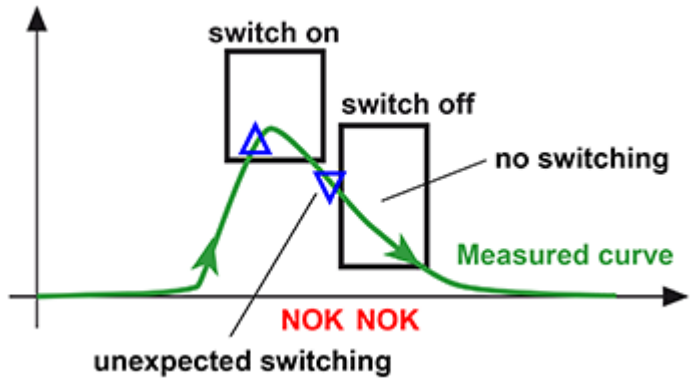

Switch actuating force too small (only for MP85A-S and haptic test)

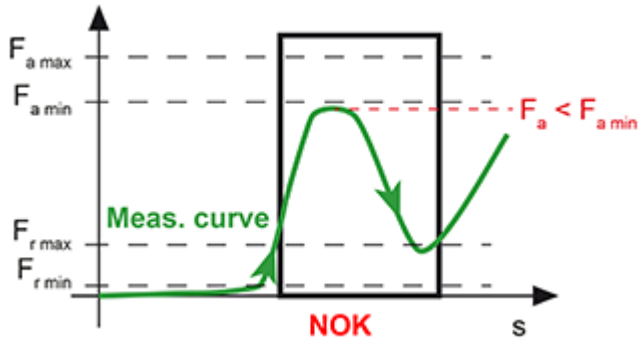

Restoration force too large (only for MP85A-S and haptic test)

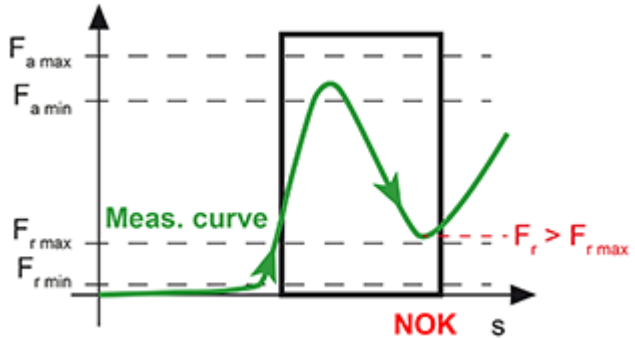

Differential force undercut (only for MP85A-S and haptic test)

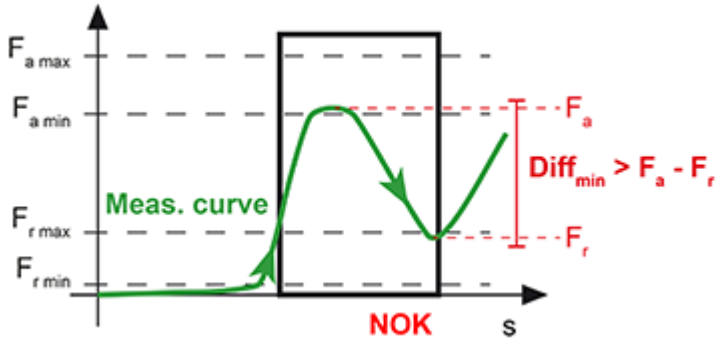

Differential displacement undercut (only for MP85A-S and haptic test)

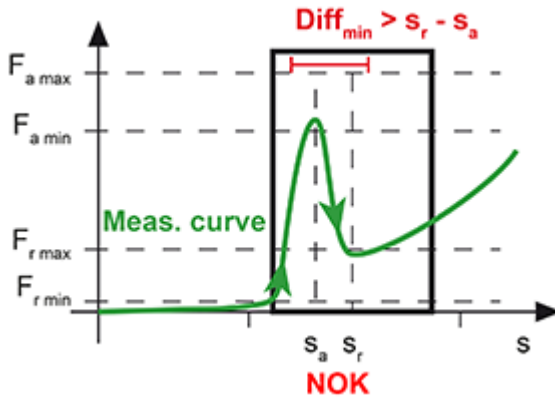

Force/displacement ratio undercut (only for MP85A-S and haptic test)

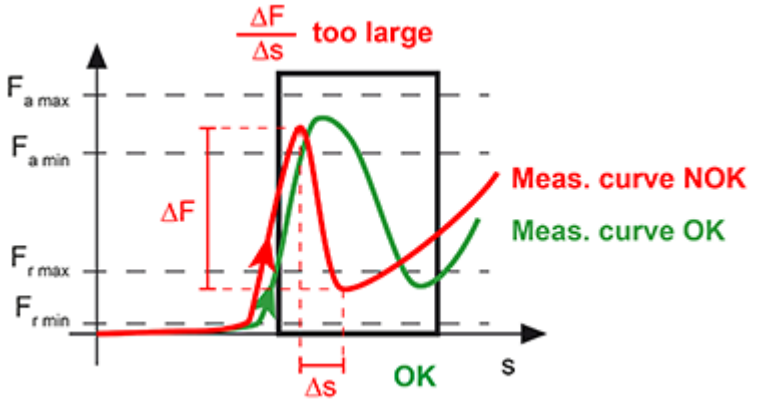

Click ratio undercut (only for MP85A-S and haptic test)

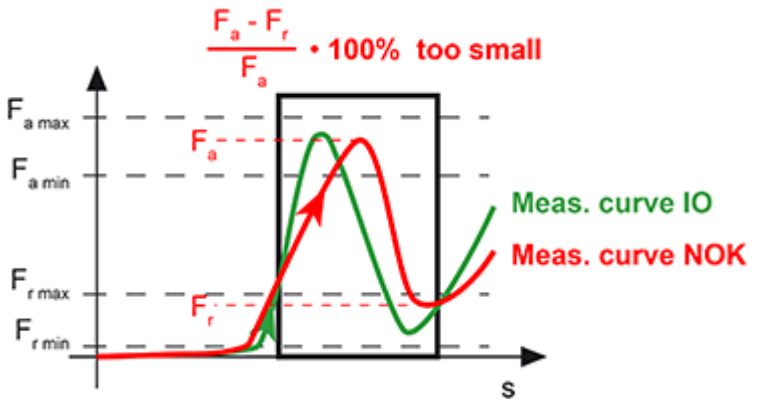

12.19 What do the LEDs on the MP85A mean?

LED 1 (OK/NOK)

LED 1 (OK/NOK) / Process status	LED red	LED yellow	LED green	LED blinking
Initializing after device power-on	X			
Alarm	X			X
Process started		X		X
Overall result OK			X	
Overall result NOK	X			

LED 2 (status)

LED 2 (status) / MP85A device status	LED red	LED yellow	LED green	LED blinking
Initializing after device power-on	X			
One of the following errors exists: EEPROM error, internal calibration error, scaling error, MMC/SD Card error or CAN bus error	X			

LED 2 (status) / MP85A device status	LED red	LED yellow	LED green	LED blinking
Transducer error, ADC overflow or gross overflow (one or both channels)	X			X
LCD error	X			X
CAN bus: sending/receiving data			X	X
“Pre-operational” state		X		
“Operational” state			X	



See also [Possible error messages and instructions for correction](#)

MP85ADP only: PROFIBUS status

MP85ADP Profibus status	LED red	LED yellow	LED green	LED blinking
Error state	X			
BD_SEAR, WT_PARM and WT_CONF states		X		
DATA_EX state			X	

Ethernet connector

LED status Ethernet connector	LED green	LED yellow
Physical connection established		on
Sending / receiving data		blinking
Transfer rate 100 MBit/s	on	
Transfer rate 10 MBit/s		on or blinking

12.20 What should be observed when saving process data, curves or process results?

If you save data using the ***with no data loss*** method, all process data is transferred onto the selected target system (PC or internal MMC/SD Card). However if it is not possible to save the data there, because for example the memory is full, the “Process ready” signal *is not issued* and the next process *cannot be started*, i.e. **the test stand is stopped**.

External storage medium

With this option, the selected data are transferred via the interface. In this case, the data are usually stored on the PC. Use the fast Ethernet interface (100 Mbit) for the shortest possible transfer times.

Data *is only saved on the PC* if a connection between PC and MP85A exists and one of the programs PME Assistant, EASYmonitor or INDUSTRYmonitor *has been started*. The respective program may however be mini-

mized. The EASYmonitor and INDUSTRYmonitor programs are components of the FASTpress Suite.

In the presetting, the files are saved to directory DATA which is created as sub-directory to the installation directory of the PME Assistant. Call the menu **File** → **Change storage directory** to enter another directory. The user logged on under Windows must have write authorization for the selected directory.

You need the NTFS file system if you record many processes: This could produce more than 65,000 files during one test which will be written into a single directory. This is only possible with a NTFS file system.

When saving data in the network, we recommend that you use the INDUSTRYmonitor program. This program has been optimized specially for fast data transfer and allows short machine-cycle times.

Storage medium MultiMediaCard/SD Card

Measuring curves, measuring results and parameter sets can be saved on the optional MMC/SD Card storage card. Depending on the card you can save a different amount of values. Approx. 15 kilobytes is required for a measuring curve with e.g. 600 value triplets (two channels plus time). That means approx. 300,000 measuring curves can be saved on a 1 GByte card. The card can be removed to read out the data even during a measurement.

Do not use High Speed cards. The rate at which the data is transferred is restricted internally. To optimize the access times of the MMC/SD Card, the card should be defragmented or re-formatted at regular intervals.

The files are always written into the MP85 directory on the MMC/SD Card. The directory will be created if it does not already exist. Further sub-directories will be created under this directory if necessary.

12.21 How does the timing diagram for a process-optimized measurement look like?

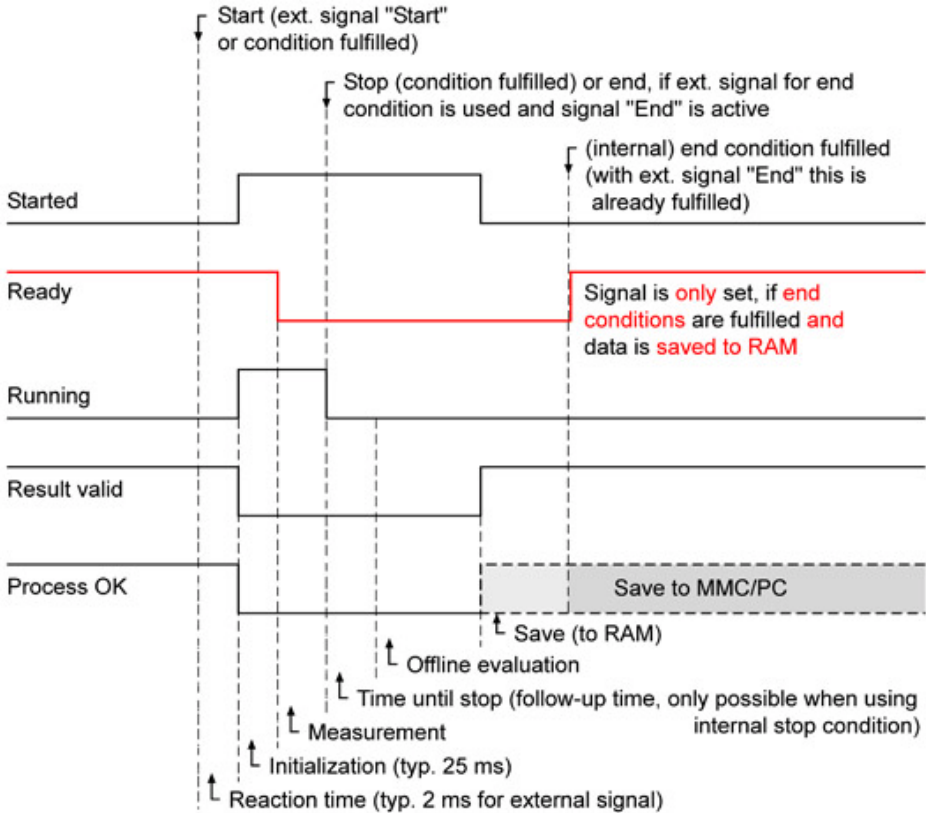

12.22 How does the timing diagram for a measurement with no data loss look like?

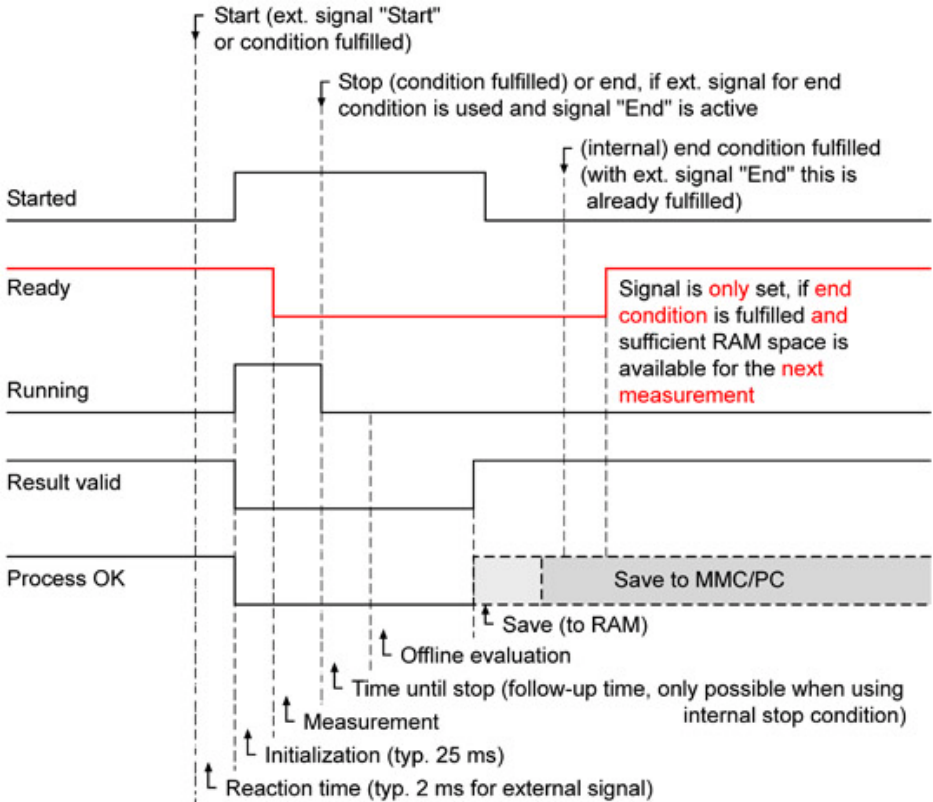

12.23 How can a digital output be set?

A digital output can be set through the following events:



- The limit value is reached in a channel.

- There is a measuring error in a channel.
- A transducer test was carried out.
- A specified process condition was reached.
- A certain tolerance window is OK.
- The transfer or MMC/SD Card memory is almost full.
- The output was set via the interface.



See also [Digital outputs](#)

12.24 How do I create a protocol printout of a process?

1. Load the processes in question via **MEASURE + VISUALIZE** → **Retrieve saved data**. The file selection dialog allows you to enter different search criteria and to search through several subdirectories.
2. Press  to call the print preview.
3. Click on  in the dialog to print the required pages and the required number of copies.



Prior to printing you may select portrait or landscape page format. However, you can also pre-select this under your Windows operating system.

You can include your company logo in the display and on the printout. Save the file containing your logo under the name LOGO.BMP or LOGO.GIF (bitmap or GIF format) in the installation directory of the PME Assistant. The logo is displayed under the overall results.



See also [Retrieve saved data](#)

12.25 How to transfer all MP85A settings to another device (cloning)?

All the settings of an MP85A can be saved to the MMC/SD Card via the MP85A keypad and then transferred to another MP85A.

Procedure for saving the settings

1. Press the **SET** key for *at least two seconds*.
CAN-BUS is displayed.
2. Press the **+** key until **System-State** is displayed.
3. Press the **SET** key.
Backup Save is displayed.
4. Confirm by pressing **SET**.

The data are now saved on the MMC/SD Card. Wait until the process has finished and the measured value is displayed again.

Procedure for loading the settings

1. Press the **SET** key for *at least two seconds*.
CAN-BUS is displayed.
2. Press the **+** key until **System-State** is displayed.
3. Press the **SET** key.
Backup Save is displayed.
4. Press the **+** key.
Backup Restore is displayed.
5. If you do not want to modify the settings for the interfaces, press the **+** key again so that **Backup Load-Com** appears (load settings without changing the communication settings).
6. Confirm by pressing **SET**.

The data are now loaded from the MMC/SD Card. Wait until the process has finished. The progress is shown in the display.



Ejecting the MMC/SD Card is described in [Procedure for changing the MMC/SD Card.](#)

12.26 How do I carry out a firmware update and can the update be prevented?

You update the firmware using the program PME-Update. With the program a new firmware version can also be transferred to several devices simultaneously. In order to avoid interfering with the running of a process when doing this (no measurement or evaluation is carried out during an update), you can specify from firmware version 2.22 that the Firmware is updated only when enabled on the device (***F-update: allowed!***), refer to [General settings \(basic settings\)](#).

12.26.1 Download firmware update

You may download the newest version of the PME Assistant software from the HBM website:



- <http://www.hbm.com/download>

You can recognize the firmware version used by your device after the start of the PME Assistant and a scan of the devices connected in the **Vers.** column (**Devices** frame). If necessary select your device (ID) from the drop down list.

12.26.2 How to update the firmware

- ☞ All device settings are preserved when updating the firmware. Nevertheless we recommend you store all settings on your PC prior to an update.

Unzip the file containing the firmware into the DOWNLOAD subfolder of the PME Assistant. Then start the PMEupdate program. The program has been installed together with the PME Assistant in the same directory. It can be accessed from the Windows **Programs** menu.

Press  to enter the network used and then  to perform a device scan. Then select the PME(s) that you

wish to update and click on  to transfer the new firmware.

- ☞ A separate Help is available in the PMEupdate program.

12.27 What does a tolerance band look like?

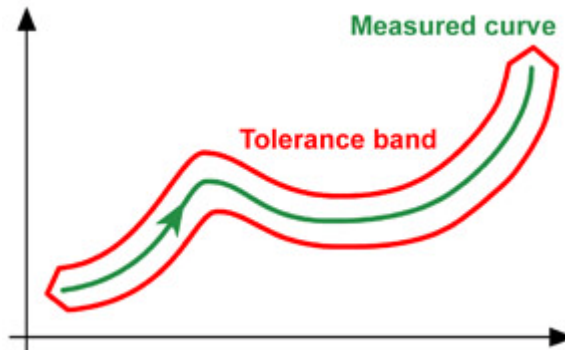

With the tolerance band, the measured curve must remain within the region of the defined tolerance band, i.e. it must not enter nor exit it.

12.28 What does an envelope curve look like?

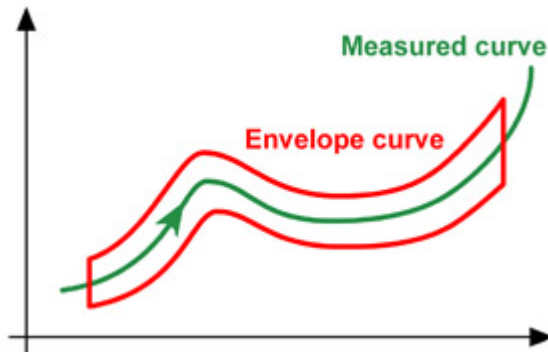

With the envelope curve the measured plot must enter and exit at the sides.

12.29 What is TEDS?

Transducer Electronic Data Sheet. The TEDS module is normally installed in the transducer and comprises a chip that contains a number that is unique worldwide (Sensor ID) together with all the data of the transducer in accordance with engineering standard IEEE P1451.4.

According to the IEEE 1451.4 standard various methods are possible for reading out the data from the TEDS module. With the PME the sense lines are used for

reading out. This method is supported, for example, by the TEDS modules available from HBM.

-  You will find further information in the publications about the standard, see Institute of Electrical & Electronics Engineers (IEEE) at <http://www.ieee.org>, National Institute of Standards and Technology (NIST) at <http://www.nist.gov> and <http://iee1451.nist.gov>.



13 Index

Symbols

* 159

Numerics

10 V 27

3D graph 178

A

Above reference value 64, 128

Access blocked to menu/window 165

Activation settings 185

Additional functions 45

Adjusting the measuring chain 29

Alarm window 71, 135

Amplifier 23

Assistant configuration 17

Asterisk label 159

Auto scaling 58, 122, 171

Automatically load all dialogs last time used 198

Automatically open settings window 197

Autoscaling 59, 123, 172

B

Background information on MP85A operation 189

Basic settings 15

Below reference value 63, 127

Bin counting 113

Block window (end window) 87

C

CAN bus 148

data storage 148

CAN bus interface 20, 190

CAN bus interface parameters 19

Carry out firmware update 189

Change log 187

Change MMC/SD Card 146

Change of parameter set 159

ChangeLog.LOG 187

Clear

process counter 55, 119, 178

statistics 55, 119, 178

Clear statistics 119

Clear statistics (dig. input) 51

Clear total statistics (dig. input) 51

Click ratio 91

- COMLOG.LOG *145, 187*
 - Compatible
 - software version is not fully compatible *196*
 - Configuration password *185*
 - Configure
 - Ethernet interface *19*
 - Configure evaluation criteria *55*
 - Configuring the MP85A interface(s) *19*
 - Confirm connection (Ethernet) *189*
 - Confirm connection established *189*
 - Connect to PME *195*
 - Connecting the PME Assistant with PME device(s) *195*
 - Consider status in evaluation *47*
 - Consider window result in total result *82*
 - Consider window sequence *93*
 - Control settings *60, 124*
 - Control signal *39*
 - Conversion of coded details in the R85 files *155*
 - Convert coded R85 data *155*
 - Convert data in R85 files *155*
 - Convert details in R85 files *155*
 - Convert numbers in R85 files *155*
 - Copy *183*
 - files from MMC/SD Card to PC *183*
 - Copy MP85A settings *189*
 - Creating and modifying tolerance windows *80*
 - Crossing window with evaluation of the x mean *84*
 - Crossing window with evaluation of the y mean *83*
 - Crossing window with min/max evaluation *83*
 - Curve history mode *173*
 - Curve with connected points *60, 123, 173*
 - Curves *150, 180*
 - display stored data *180*
 - save *150*
- D**
- Data reduction *60, 124, 189*
 - Data storage *145*
 - Data word bit (dig. output) *47*
 - Date/time *16*
 - Define evaluation mode *119*
 - Define passcode *17*
 - Defining a tolerance band *140*
 - Defining tolerance windows *79*

- Delete 184
 - files on MMC/SD Card 183
- Device name 15
- Dialog
 - locked 165
 - not available 17
- Differential displacement 91
- Differential force 91
- Digital I/O
 - status display 165
- Digital inputs 51
- Digital outputs 47
- Directories used on the MMC/SD Card 151
- Display company logo 180
- Display connection loss detection 187
- Display current values (measurement display) 165
- Display results/curves 171
- Display stored data 180
- Display/print logo 180
- Distribution (bin counting) 113, 179
- Download firmware update 242
- E**
- EASYsetup 185
- EASYsetup password 185
- EASYteach 186
- End condition 189
- End conditions 66, 130
- End of the measurement 189
- End window 87
- Enter license key 185
- Entering the Transducer Characteristic 33
- Entry (evaluation) 104
- Envelope curve 143, 185
- Error
 - entry condition not fulfilled 106, 226
 - exit condition fulfilled before entry condition 106, 226
 - exit condition not fulfilled 106, 226
 - Max. x (x too large) 106, 226
 - Max. y (y too large) 106, 226
 - Min. x (x too small) 106, 226
 - Min. y (y too small) 106, 226
- Error messages 168
- Error messages during tolerance window violations 106, 226
- Error status 168
- Ethernet 148
 - data storage 148
- Ethernet connector 236
- Ethernet interface 19

- Ethernet interface parameters 19
- Evaluate $y(t)$ plots 25
 - time as measurement channel 25
- Evaluation criteria, specify 55
- Evaluation for entry and exit of window 104
- Evaluation mode 55
- Exceeding set-point value 62, 126
- Excel
 - Importing data 153
- Exchange MMC/SD Card 146
- Exit (evaluation) 104
- External end signal 66, 130
- External start signal 62, 126
- F**
- FAQ
 - Data reduction 201
 - How can a digital output be set? 239
 - questions and answers about MP85A and PME Assistant 189
- FAQ: How do I create a protocol print-out of a process? 240
- FAQ: Possible error messages and instructions for correction 168
- FAQ: Save process data (curves/results) 236
- FAQ: Timing diagrams for different Start/Stop/End conditions 205
- File 150, 151
 - directories used 151
 - names and directories 151
 - save 150
- File formats 153
- Files 183
 - copy from MMC/SD Card to PC 183
 - delete on MMC/SD Card 183
- Files on MMC/SD Card (copy to/from PC) 183
- Files to save 150
- Filter 40, 41
- Filter settings (table, refer to Sample rates) 189
- Firmware update only possible after release on the device 16
- Fixed scaling 58, 122, 171
- Flow diagram
 - of a measurement 189
 - of zero balancing 189
 - parameter set switching 189
- Follow-up time 63, 127
- Force/displacement ratio 91
- Forgotten passcode 17
- Formats of files 153
- Full bridge 26

G

General settings (basic settings) 15

Generate log printout 189

Graph (3D) 178

Graph settings 60, 123, 173

Graph zoom 171

 see Graph scaling 171

H

Half bridge 26

Haptic parameters 89, 182

Haptic test 10, 89

Hardware synchronization 16

Hardware version of the MP85A 15

How do I work when setting up the
evaluation criteria? 219

I

Identify connected PMEs 195

Important 9

Important information about tolerance
windows 76

Importing data to Excel 153

Interface commands 19

Interface parameters 18

Internal memory (almost) full (dig. out-
put) 47

Introduction and comparison of the
procedures 30

L

Label * 159

Label with asterisk 159

Language 15

Leaving the Start condition 66, 130

LED 1 (OK/NOK) 234

LED 2 (status) 234

License key

 entering 185

Limit value in channel (dig. output) 47

Limit values 45

 as auxiliary lines in the graph 45

 setting 45

 status 165

Load

 from flash 159

 from MMC/SD Card 159

 from PC 159

Load factory setting 159

Load parameter set (dig. input) 51

Locked menus/windows 165

Log process 189

Low-pass filter 40

LVDT 26, 27

- M**
- MAC address 18
- Manual scaling 59, 123, 173
 - see Graph scaling 171
- Master passcode 17
- Maximum measuring time 61, 125
- Meaning of the error messages during tolerance window violations 106, 226
- MEASURE + VISUALIZE 165
- Measure transducer characteristic 38
- Measurement 180
 - display stored data 180
 - results of the last ~ 176
- Measurement curve 171
- Measurement preparation 23
- Measurement range, refer to Half bridge 25
- Menu
 - locked 165
 - not available 17
- Menu blocked 17
- Menu locked/not accessible 165
- Merge window 92
- Missing menu/dialog 17
- MMC prerequisites 189
 - MMC/SD Card 146, 151, 183
 - delete files 183
 - directories used 151
 - FAT16 as format required 146
 - storage medium 146
 - MMC/SD Card exchange 146
 - MMC/SD Card memory (almost) full (dig. output) 47
 - Monitoring with envelope curve 143
 - Monitoring with tolerance band settings 119
 - Mounting mode 189
 - MP01 9
 - MP30 9
 - MP55 9
 - MP60 9
 - MP70 9
 - MP85 9
 - MP85A 9
 - MP85ADP only: PROFIBUS status 235
 - MP85A-S 87, 89, 176, 178, 182
 - MultiMediaCard 146
- N**
- Name of parameter set 159
- Necessary settings 10

- No access to menu/window *165*
- No data loss (save) *149*
- No switching process *178*
- Not compatible *195*
 - software version is not fully compatible *196*
- NTFS *189*
- Number of files *150*
- Number of saved curves *151*
- O**
- Online window *91*
- Optimized process (save) *149*
- Options *187*
- Options when starting *197*
- P**
- Parameter set name *160*
- Parameter set switching *189*
- Parameter set, loading (dig. input) *51*
- Parameterization
 - CAN bus interface *20, 190*
 - PROFIBUS interface *21, 191*
- Passcode
 - define *17*
 - reactivate *17*
- Password
 - EASYsetup *185*
- Password see passcode *17*
- Plus tools *185*
- PME family *9*
- Potentiometer *26*
- PREPARE MEASUREMENT *23*
- Prepare MP85A for your application *23*
- Prerequisites for MMC/SDcard *189*
- Presentation differences in relative windows *174*
- Prevent firmware update *189*
- Principle procedure *56, 120*
- Print company logo in the log *180*
- Print log *180*
- Print logo *180*
- Print process data *180*
- Print process data with company logo *180*
- Printout of process data *180*
- Process *47*
 - Alarm (dig. output) *47*
 - Not OK (dig. output) *47*
 - OK (dig. output) *47*
 - Ready (dig. output) *47*
 - Result processed (dig. output) *47*
 - Running (dig. output) *47*
 - Started (dig. output) *47*

- Process counter *151, 176*
 - reset *178*
- Process counter, clear *55*
- Process number *151, 176*
- PROFIBUS interface (only with MP85ADP) *21, 191*
- PROFIBUS interface parameters *19*
- Profile *185*
- Program version of the MP85A *15*
- Pulse generator *27*
- Q**
- Quick start *9*
- R**
- Range window *72, 136*
- Reactivate passcode *17*
- Real time *91*
 - evaluation with window *91*
- Recognize connected PME's *195*
- refer to number of stored curves *150*
- Refresh the tree of the settings window *197*
- Relative (y coordinates) *99*
- Relative differential force *91*
- Relative window *99, 101*
- Reset
 - process counter *55, 119, 178*
 - statistics *55, 178*
 - Zoom, see Graph scaling *171*
- Reset all the setting *159*
- Reset process counter *119*
- Restoration force *90*
- Results *145, 150, 180*
 - 3D graph *178*
 - display stored data *180*
 - of last measurement *176*
 - save *150*
 - saving, data storage *145*
- Ring buffer *150*
 - refer to number of stored curves *150*
- S**
- Sample rates (table) *189*
- Save
 - in flash *159*
 - in MMC/SD Card *159*
 - in PC *159*
 - no data loss *149*
 - optimized process *149*
- Save statistical data, statistical processing *157*
- Save statistics (dig. input) *51*
- SAVE/LOAD PARAMETERS *159*
- Saving method *149*
- Scale graph *58, 122, 171*

- Scaling
 - automatically 59, 123, 172
 - manually 59, 123, 173
- Scan connected PMEs 195
- SD Card 146
- SDcard prerequisites 189
- Sensor error 38
- Serial number of the MP85A 15
- Set digital output 189
- Set evaluation mode 119
- Set tolerance band 119
- Setting the IP address of the PC 192
- Setting up the hardware 11
- Settings
 - for CAN bus interface 19
 - for Ethernet interface 19
 - for PROFIBUS interface 19
- Settings for monitoring using tolerance windows 55
- Settings, necessary 10
- Setup 10, 11
- Setup of the measuring chain (MP85A and transducer) 23
- Show currently measured values 165
- Shunt 39
- Shunt calibration (dig. input) 51
- Signal conditioning (zero balance, low-pass filter) 40
- Specify evaluation criteria 55
- Specify transducer 25
- SSI generator 28
- SSI interface 28
- Standstill recognition 63, 126
- Start conditions 62, 126
- Start options 189, 197
- Start transducer test (dig. input) 51
- Start with external signal, stop and end with conditions 207
- Start with external signal, stop with condition, end with external signal 206
- Start/end with external signal, manually or with interface commands 206
- Start/Stop process (dig. input) 51
- Start/stop with conditions, end when leaving the Start condition 210
- Start/stop with conditions, end with external signal 208
- Start/stop/end of the measurement 189
- Start/stop/end with conditions 208
- Statistical processing 157
- Statistics 113, 177
 - reset 178

- Statistics and distribution (bin counting) 113
 - Statistics, clear 55
 - Statistics, clear (dig. input) 51
 - Statistics, save (dig. input) 51
 - Status information 165
 - Status line 172
 - symbols used 171
 - Status messages 172
 - Status of digital I/O 165
 - Status of error display 168
 - Status of limit values 165
 - Status of measurement display 168
 - Stop conditions 62, 126
 - Storage directory 152
 - Storage medium external (storage via CAN bus or Ethernet) 148
 - Storage medium MultiMediaCard/SD Card (target MMC/SD Card internal) 146
 - Storage methods 149
 - Strain-gauge transducer, refer to Full bridge 25
 - Supply voltage, refer to Transducer types 25
 - Switch actuating force 90
 - Switch input 87
 - Switch test 9, 54, 87
 - Switching coordinates 182
 - Switching direction 87
 - Switching process repeated 178
 - Symbols for switch test 87, 176
 - Symbols in status line 58, 122, 171
 - Synchronization 16
 - SYSTEM settings 15
- T**
- Take sequence (window) into account 93
 - Target memory external via CAN/Ethernet 148
 - Target memory MMC/SD Card (internal) 146
 - Test measurement (start measurement manually) 74, 138
 - Test phase 219
 - The Configure evaluation parameter window 58, 122
 - The MP85A measuring system 9
 - This software version is not fully compatible 196
 - Time 28
 - Time as a measurement channel 25
 - Tolerance band 140

- Tolerance window
 - create 80
 - modify 80
 - relative 101
 - statistics 113
- Tolerance window OK (dig. output) 47
- Tolerance window setup 55
- Tolerance windows 79
- Transducer 25
- Transducer error 38
- Transducer test 43, 189
- Transducer test (dig. input) 51
- Transducer test result channel (dig. output) 47
- Transfer MP85A settings 189
- Transferring MP85A settings to another device (cloning) 241
- U**
- Undercutting set-point value 62, 126
- Update of firmware 243
- Using TEDS 32
- V**
- View results/curves 171
- W**
- What needs to be done? 10
- Window 82, 99
 - active 82
 - evaluation in real time 91
 - locked 165
 - relative (x coordinates) 101
- Window option Consider window sequence 93
- Window option of evaluation in real time (online window) 91
- Window option x coordinates relative to 101
- Window option y coordinates relative 99
- Windows 10
 - change IP address of PC 192
- Windows 8
 - change IP address of PC 192
- X**
- x limit 86
- x too large 106, 226
- x too small 106, 226
- Y**
- y limit 85
- y too large 106, 226
- y too small 106, 226

Z

Zero balancing *40, 189*

Zero balancing (dig. input) *51*

Zero reference *41*

Zoom

in graph *171*

Reset, see Graph scaling *171*

see Graph scaling *171*

HBM Test and Measurement

Tel. +49 6151 803-0

Fax +49 6151 803-9100

info@hbm.com

measure and predict with confidence



www.hbm.com