

DATA SHEET

# QUANTUM<sup>X</sup> MX1601B Universal amplifier

SPECIAL FEATURES

- 16 individually configurable inputs (electrically isolated)
- Connection of standard signals (60 V, 10 V, 100 mV, 20 mA, IEPE)
- Sampling rate: up to 20000 Hz per channel, active low-pass filter
- TEDS support
- Configurable power supply to active transducers (DC)



BLOCK DIAGRAM

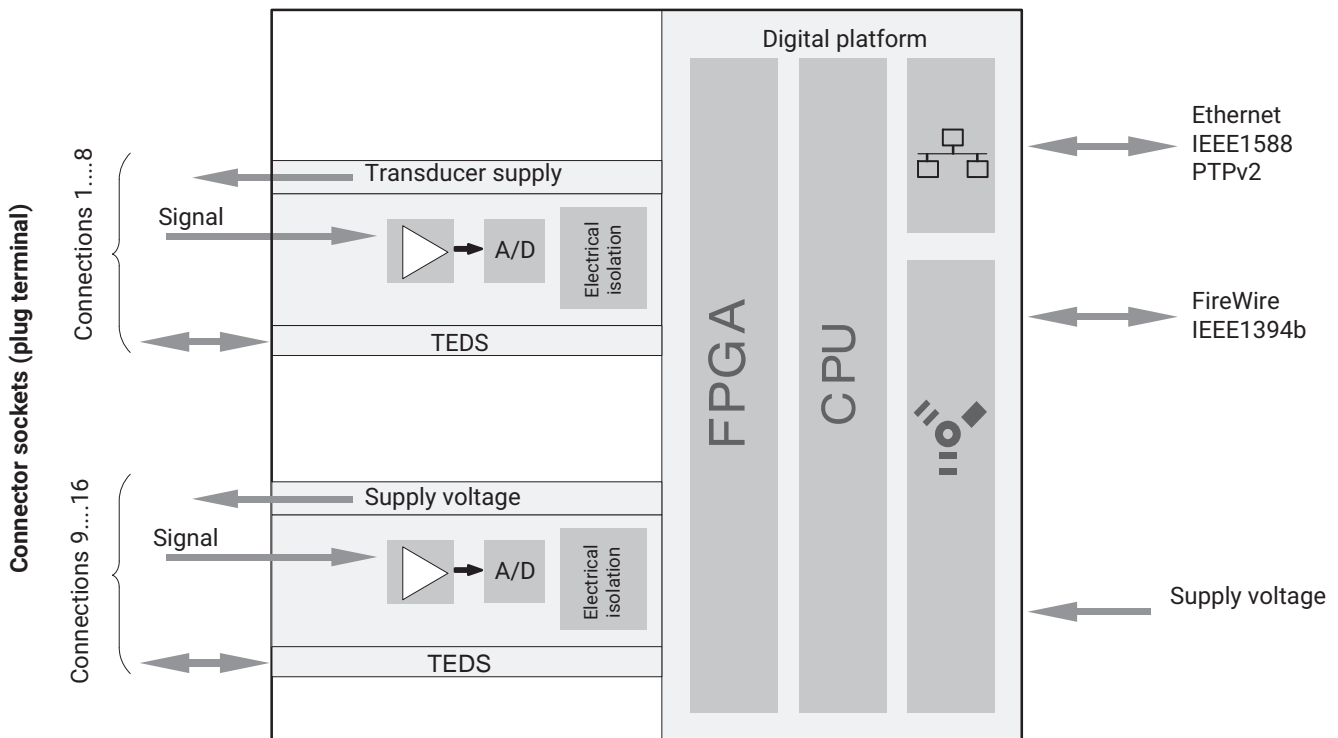

## SPECIFICATIONS FOR MX1601B

General specifications		
<b>Inputs</b>	Number	16, electrically isolated from each other and to supply <sup>1)</sup>
<b>Transducer technologies per connector</b>		Voltage, current, current-fed piezoelectric sensors (IEPE)
<b>A/D conversion per channel</b>		24-bit delta-sigma converter
<b>Sampling rates (domain can be set via the software, factory setting is "HBM Classic")</b>	S/s	Decimal: 0.1 ... 20,000 HBM Classic: 0.1 ... 19,200
<b>Signal bandwidth</b>	Hz	3800 (-3dB) with linear phase filter
<b>Active low-pass filter</b>	Hz	Bessel, Butterworth, linear phase 0.01 ... 3000 (-3 dB), filter OFF
<b>Transducer identification (TEDS chip, IEEE 1451.4)</b> Max. TEDS module distance	m	100
<b>Transducer connection</b>		Plug terminal Phoenix Contact FMC-1,5/8-ST-3,5-RF
<b>Supply voltage range (DC)</b>	V	10 ... 30 (nominal (rated) voltage 24 V)
<b>Supply voltage interruption</b>		max. for 5 ms at 24 V
<b>Power consumption</b> without adjustable transducer excitation voltage with adjustable transducer excitation voltage	W W	< 10 < 13
<b>Transducer excitation voltage (active transducers)</b> Channels 1 ... 8 only: Adjustable supply voltage (DC) Maximum output power Channels 9 ... 16 only: Supply voltage (DC) Maximum output current	V W V mA	5 ... 24; adjustable channel by channel 0.7 per channel / 2 in total  9 ... 29, voltage supply to module -1 V 30 per channel / 75 in total
<b>Ethernet (data link)</b> Protocol/addressing Plug connection Max. cable length to module	- - m	10Base-T/100Base-TX TCP/IP (static IP/DHCP, IPv4/IPv6) 8P8C plug (RJ-45) with twisted-pair cable (CAT-5) 100
<b>Synchronization options</b> EtherCAT <sup>®2)</sup> IRIG-B (B000 to B007; B120 to B127) IEEE1588 (PTPv2), NTP PROFINET		IEEE1394b FireWire (QuantumX only, automatic, recomm.) via CX27B via MX440B or MX840B input channel Ethernet-based Network Time Protocol
<b>IEEE1394b FireWire (module synchronization, data link, optional power supply)</b> Baud rate Max. current from module to module Max. cable length between nodes Max. number of modules connected in series (daisy chain) Max. number of modules in one FireWire system (including hubs <sup>3)</sup> , backplane) Max. number of hops <sup>4)</sup>	MBaud A m - - -	IEEE 1394b (HBM modules only)  400 (approx. 50 MBytes/s) 1.5 5 12 (= 11 hops) 24 14
<b>Nominal (rated) temperature range</b>	°C	-20 ... +65
<b>Storage temperature range</b>	°C	-40 ... +75
<b>Relative humidity</b>	%	5 ... 95 (non-condensing)
<b>Protection class</b>		III
<b>Equipment protection level</b>		IP20 per EN60529
<b>Mechanical tests<sup>5)</sup></b> Vibration (30 min) Shock (6 ms)	m/s <sup>2</sup> m/s <sup>2</sup>	50 350
<b>EMC requirements</b>		per EN 61326-1

<b>Max. input voltage at transducer socket to ground (pin 2)</b>		without transients
Pin 4 (TEDS)	V	+5
Pin 1 (voltage)	V	±60
Pin 3 (current)	V	±1,5
Pin 5 (control circuit)	V	±3.3
<b>Dimensions, horizontal (H x W x D)</b>	mm	52.5 x 200 x 122 (with case protection) 44 x 174 x 119 (without case protection)
<b>Weight, approx.</b>	g	980
<b>Voltage ±10 V</b>		
<b>Accuracy class</b>		0.03
<b>Transducers that can be connected</b>		Voltage sources up to ±10 V
<b>Permissible cable length between MX1601B and transducer</b>	m	100
<b>Measurement range</b>	V	±10
<b>Internal resistance of connected voltage source</b>	kΩ	< 5
<b>Input impedance</b>	MΩ	> 10
<b>Noise at 25 °C (peak-to-peak)</b>		
with 1 Hz Bessel filter	μV	100
with 10 Hz Bessel filter	μV	100
with 100 Hz Bessel filter	μV	200
with 1000 Hz Bessel filter	μV	400
with filter OFF / 19200 values/s	μV	700
<b>Non-linearity</b>	%	< 0.02 of full scale value
<b>Common-mode rejection</b>		
with DC common mode	dB	> 100
with 50 Hz common mode, typically	dB	95
<b>Max. common-mode voltage (to housing and supply ground)</b>	V	±60
<b>Zero drift</b>	%/10 K	< 0.03 of full scale value
<b>Full-scale drift</b>	%/10 K	< 0.03 of measured value
<b>Voltage ±60 V</b>		
<b>Accuracy class</b>		0.05
<b>Transducers that can be connected</b>		Voltage sources up to ±60 V
<b>Permissible cable length between MX1601B and transducer</b>	m	100
<b>Measurement range</b>	V	±60
<b>Internal resistance of connected voltage source</b>	Ω	< 500
<b>Typical input impedance</b>	MΩ	1
<b>Noise at 25 °C (peak-to-peak)</b>		
with 1 Hz Bessel filter	μV	< 500
with 10 Hz Bessel filter	μV	< 600
with 100 Hz Bessel filter	μV	< 800
with 1000 Hz Bessel filter	μV	< 2000
<b>Non-linearity</b>	%	< 0.02 of full scale value
<b>Common-mode rejection</b>		
with DC common mode	dB	> 100
with 50 Hz common mode, typically	dB	75
<b>Max. common-mode voltage (to housing and supply ground)</b>	V	±60
<b>Zero drift</b>	%/10 K	< 0.03 of full scale value
<b>Full-scale drift</b>	%/10 K	< 0.05 of measured value

<b>Voltage ±100 mV</b>		
<b>Accuracy class</b>		0.1
<b>Transducers that can be connected</b>		Voltage sources up to ±100 mV
<b>Permissible cable length between MX1601B and transducer</b>	m	100
<b>Measurement range</b>	mV	±100
<b>Internal resistance of connected voltage source</b>	Ω	< 200
<b>Input impedance</b>	MΩ	> 10
<b>Noise at 25 °C (peak-to-peak)</b>		
with 1 Hz Bessel filter	μV	3
with 10 Hz Bessel filter	μV	5
with 100 Hz Bessel filter	μV	12
with 1000 Hz Bessel filter	μV	25
with filter OFF / 19200 values/s	μV	40
<b>Non-linearity</b>	%	< 0.02 of full scale value
<b>Common-mode rejection</b>		
with DC common mode	dB	> 100
with 50 Hz common mode, typically	dB	95
<b>Max. common-mode voltage (to housing and supply ground)</b>	V	±60
<b>Zero drift</b>	%/10 K	< 0.03 of full scale value
<b>Full-scale drift</b>	%/10 K	< 0.03 of measured value
<b>Current 20 mA</b>		
<b>Accuracy class</b>		0.05
<b>Transducers that can be connected</b>		Transducers with 0 ... 20 mA or 4 ... 20 mA current output
<b>Permissible cable length between MX1601B and transducer</b>	m	100
<b>Measurement range</b>	mA	±20
<b>Measuring resistance value</b>	Ω	5
<b>Noise at 25 °C (peak-to-peak)</b>		
with 1 Hz Bessel filter	μA	0.5
with 10 Hz Bessel filter	μA	1
with 100 Hz Bessel filter	μA	3
with 1000 Hz Bessel filter	μA	6
with filter OFF / 19200 values/s	μA	10
<b>Non-linearity</b>	%	< 0.02 of full scale value
<b>Common-mode rejection</b>		
with DC common mode	dB	> 100
with 50 Hz common mode, typically	dB	95
<b>Max. common-mode voltage (to housing and supply ground)</b>	V	±60
<b>Zero drift</b>	%/10 K	< 0.05 of full scale value
<b>Full-scale drift</b>	%/10 K	< 0.05 of measured value
<b>Current-fed piezoelectric transducers (IEPE, Integrated Electronics Piezo Electric)</b>		
<b>Accuracy class</b>		0.1
<b>Transducer technology</b>		Current-fed piezoelectric transducer
<b>Permissible cable length between MX1601B and transducer</b>		
Lay only inside closed buildings	m	< 30
<b>Transducer excitation</b>	mA	4,0 mA ±15%
<b>Measuring range (AC)</b>	V	±10
<b>IEPE compliance voltage, typically</b>	V	20
<b>Measurement frequency range (-3 dB)</b>	Hz	0.34 ... 3000

<b>Input impedance</b>	MΩ	> 1
<b>Noise at 25 °C</b>		
with 1 Hz Bessel filter	μV	100
with 10 Hz Bessel filter	μV	150
with 100 Hz Bessel filter	μV	400
with 1000 Hz Bessel filter	μV	800
with filter OFF / 19200 values/s	μV	1000
<b>Non-linearity</b>	%	< 0.1 of full scale value
<b>Common-mode rejection</b>		
with DC common mode	dB	> 100
with 50 Hz common mode, typically	dB	95
<b>Max. common-mode voltage (to housing and supply ground)</b>	V	±60
<b>Zero drift</b>	%/10 K	< 0.1 of full scale value
<b>Full-scale drift</b>	%/10 K	< 0.1 of measured value

- 1) When using variable transducer excitation voltage, clear the electrical isolation from the supply.
- 2) EtherCAT) is a registered brand and patented technology, licensed by Beckhoff Automation GmbH, Germany
- 3) Hub: IEEE1394b FireWire node or distributor
- 4) Hop: transition from module to module or signal conditioning/distribution via IEEE1394b FireWire (hub, backplane)
- 5) Mechanical stress is tested in accordance with European standards EN60068-2-6 for vibration and EN60068-2-27 for shock. The devices are exposed to an acceleration of 50 m/s<sup>2</sup> within the frequency range 5...65 Hz in all 3 axes. Duration of this vibration test: 30 minutes per axis. The shock test is implemented at a nominal (rated) acceleration of 350 m/s<sup>2</sup> for a duration of 6 ms, half sine and with shocks in each of the six possible directions.

## DECIMAL SAMPLING RATES AND DIGITAL LOW-PASS FILTERS, 4TH ORDER BESSEL

Type	-1 dB (Hz)	-3 dB (Hz)	-20 dB (Hz)	Runtime <sup>1)</sup> (ms)	Rise time (ms)	Overshoot (%)	Sampling rate (Hz)
Bessel	1,203	2,000	3,830	0.088	0.199	4.8	20,000
	596	1,000	2,494	0.232	0.353	1.1	20,000
	298	502	1,278	0.552	0.700	0.9	20,000
	119	200	509	1.56	1.76	0.9	20,000
	59	100	254	3.21	3.51	0.9	20,000
	29.6	50	127.1	6.50	7.01	0.9	20,000
	11.8	20	50.8	16.4	17.6	0.9	20,000
	5.9	10	25.4	32.9	35.1	0.9	20,000
	2.96	5	12.70	69.0	70.1	0.9	10,000
	1.18	2	5.08	168	176	0.9	10,000
	0.59	1	2.54	333	351	0.9	5,000
	0.295	0.5	1.271	663	701	0.9	1,000
	0.118	0.2	0.508	1,660	1,760	0.9	1,000
	0.059	0.1	0.254	3,300	3,510	0.9	500
	0.0295	0.05	0.1271	6,620	7,010	0.9	100
	0.0118	0.02	0.0508	16,500	17,600	0.9	100
0.0059	0.01	0.0254	33,000	35,100	0.9	50	

<sup>1)</sup> The A/D converter delay time for all sampling rates is 128 ms and this is not taken into account in the "runtime" column! Also not included is the runtime of the analog anti-aliasing filter (160 µs). This means that 288 µs have to be added to the "runtime".

## DECIMAL SAMPLING RATES: BESSEL FILTER AMPLITUDE RESPONSE

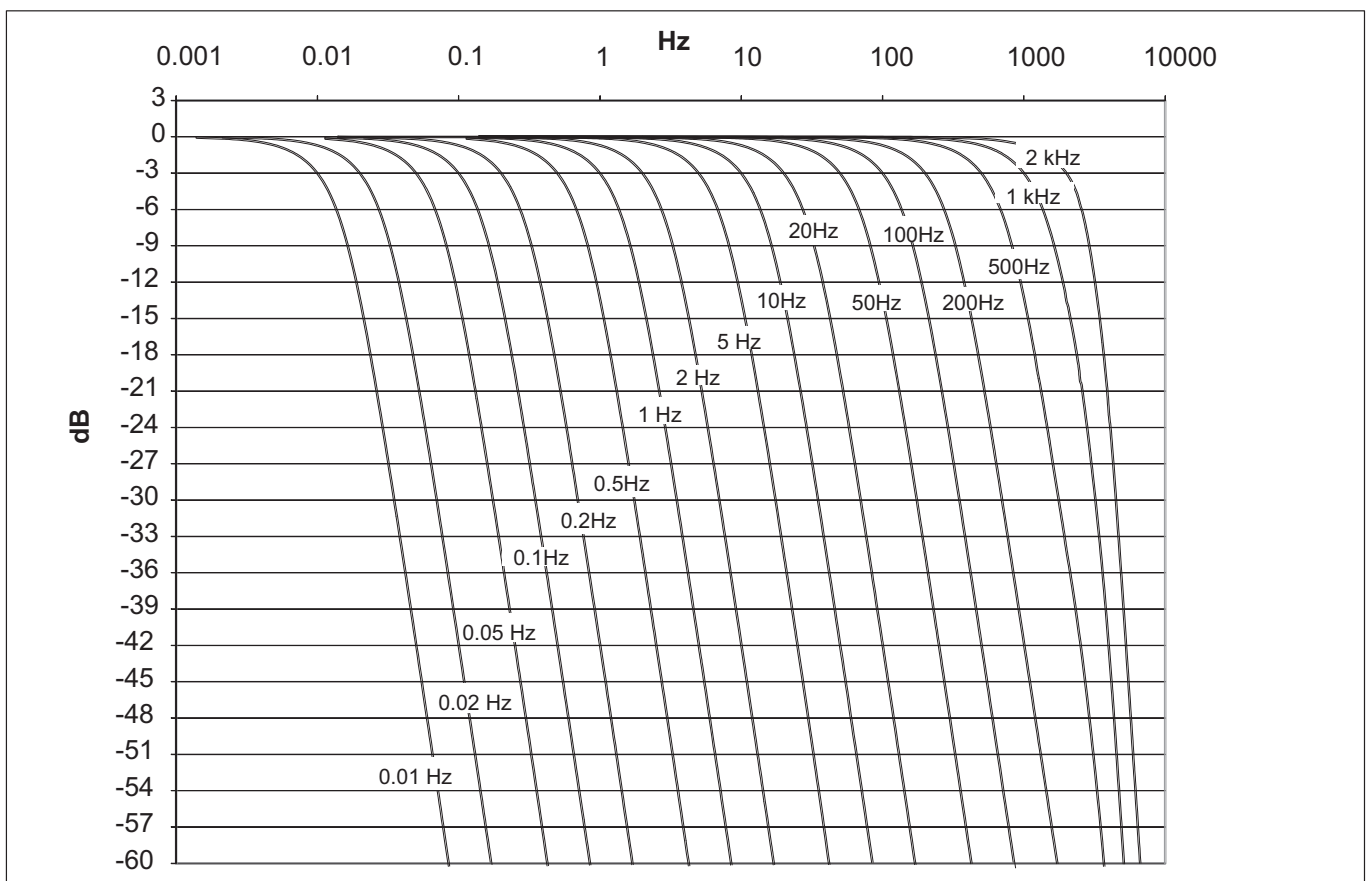

## DECIMAL SAMPLING RATES AND DIGITAL LOW-PASS FILTERS, 4TH ORDER BUTTERWORTH

Type	-1 dB (Hz)	-3 dB (Hz)	-20 dB (Hz)	Runtime <sup>1)</sup> (ms)	Rise time (ms)	Overshoot (%)	Sampling rate (Hz)
Butterworth	2,612	3,000	4,316	0.105	0.161	17.0	20,000
	1,703	2,000	3,600	0.213	0.217	14.2	20,000
	838	1,000	1,746	0.436	0.394	11.3	20,000
	430	500	890	0.884	0.777	11.0	20,000
	169	200	355	2.27	1.94	11.0	20,000
	84	100	178	4.51	3.88	11.0	20,000
	42.2	50	88.8	9.00	7.75	11.0	20,000
	16.9	20	35.5	22.5	19.4	11.0	20,000
	8.4	10	17.8	45.0	38.8	11.0	20,000
	4.22	5	8.88	89.9	77.5	11.0	20,000
	1.68	2	3.55	225	194	11.0	20,000
	0.84	1	1.78	449	387	11.0	20,000
	0.423	0.5	0.888	898	774	11.0	10,000
	0.169	0.2	0.356	2,250	1,940	11.0	10,000
	0.084	0.1	0.178	4,490	3,870	11.0	5,000
	0.0422	0.05	0.0888	8,980	7,740	11.0	1,000
	0.0168	0.02	0.0356	22,500	19,400	11.0	1,000
	0.0085	0.01	0.0178	44,900	38,700	11.0	500

<sup>1)</sup> The A/D converter delay time for all sampling rates is 128 ms and this is not taken into account in the "runtime" column! Also not included is the runtime of the analog anti-aliasing filter (160 μs). This means that 288 μs have to be added to the "runtime".

## DECIMAL HBM SAMPLING RATES: BUTTERWORTH FILTER AMPLITUDE RESPONSE

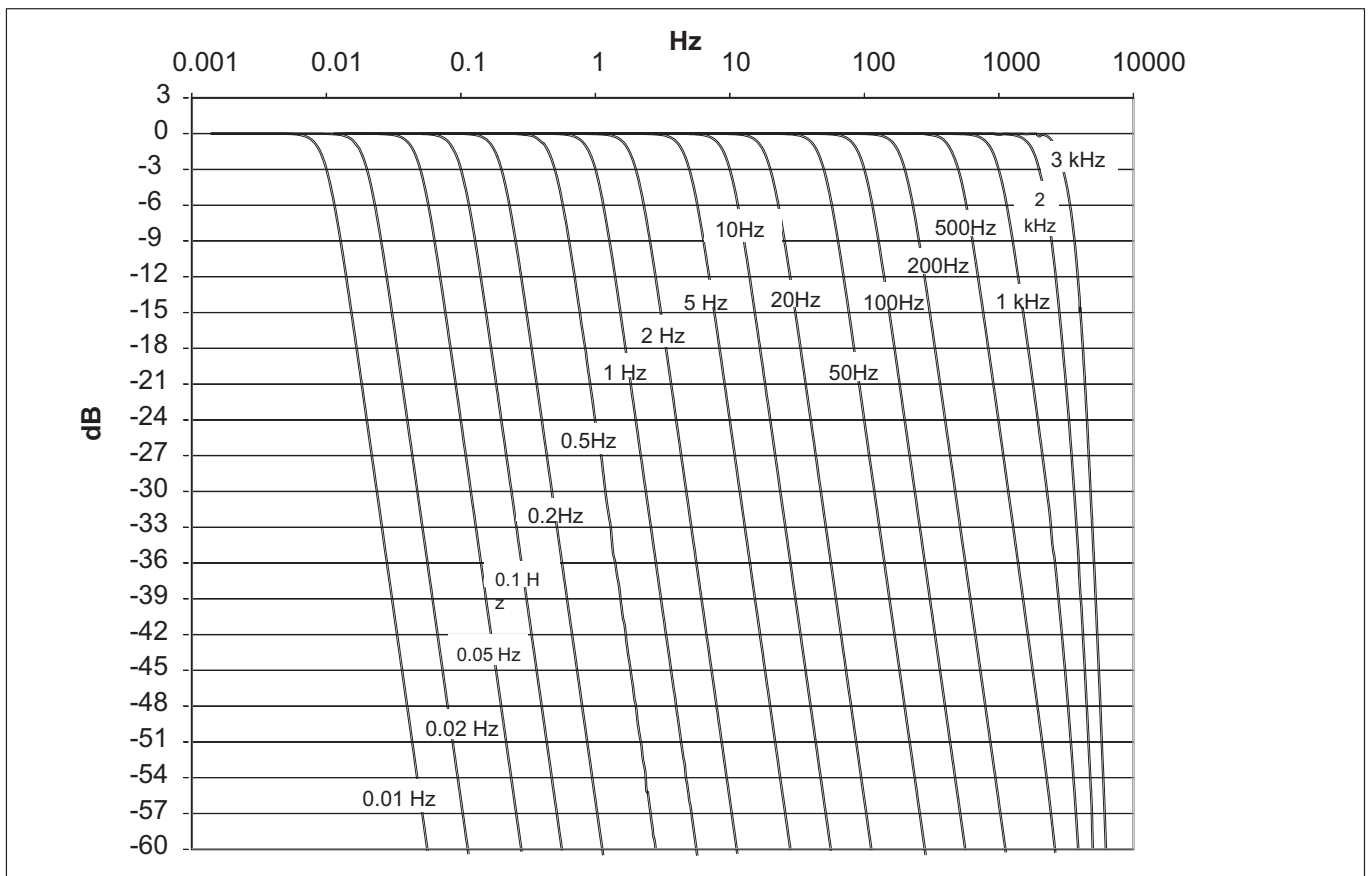

## DECIMAL SAMPLING RATES AND DIGITAL LOW-PASS FILTERS, LINEAR PHASE (FIR)

Type	Start of level drop	-3 dB (Hz)	-20 dB (Hz)	Runtime <sup>1)</sup> (ms)	Rise time (ms)	Overshoot (%)	Sampling rate (Hz)
Linear phase	3,333	3,800	4,580	0.802	0.121	13.8	20,000
	1,667	1,118	2,694	2.77	0.276	9.4	5,000
	1,000	1,050	1,308	6.21	0.545	8.6	2,500
	833	825	1,346	4.00	0.552	8.6	2,500
	667	838	1,078	4.70	0.696	8.6	1,000
	333	420	539	10.4	1.39	8.6	1,000
	167	210	269	26.9	2.73	8.6	500
	67	84	108	50.2	6.88	8.6	200
	33	42	54	108	13.8	8.6	100

<sup>1)</sup> The A/D converter delay time for all sampling rates is 128 ms and this is not taken into account in the "runtime" column! Also not included is the runtime of the analog anti-aliasing filter (160 μs). This means that 288 μs have to be added to the "runtime".

## DECIMAL SAMPLING RATES: AMPLITUDE RESPONSE, LINEAR PHASE (FIR)

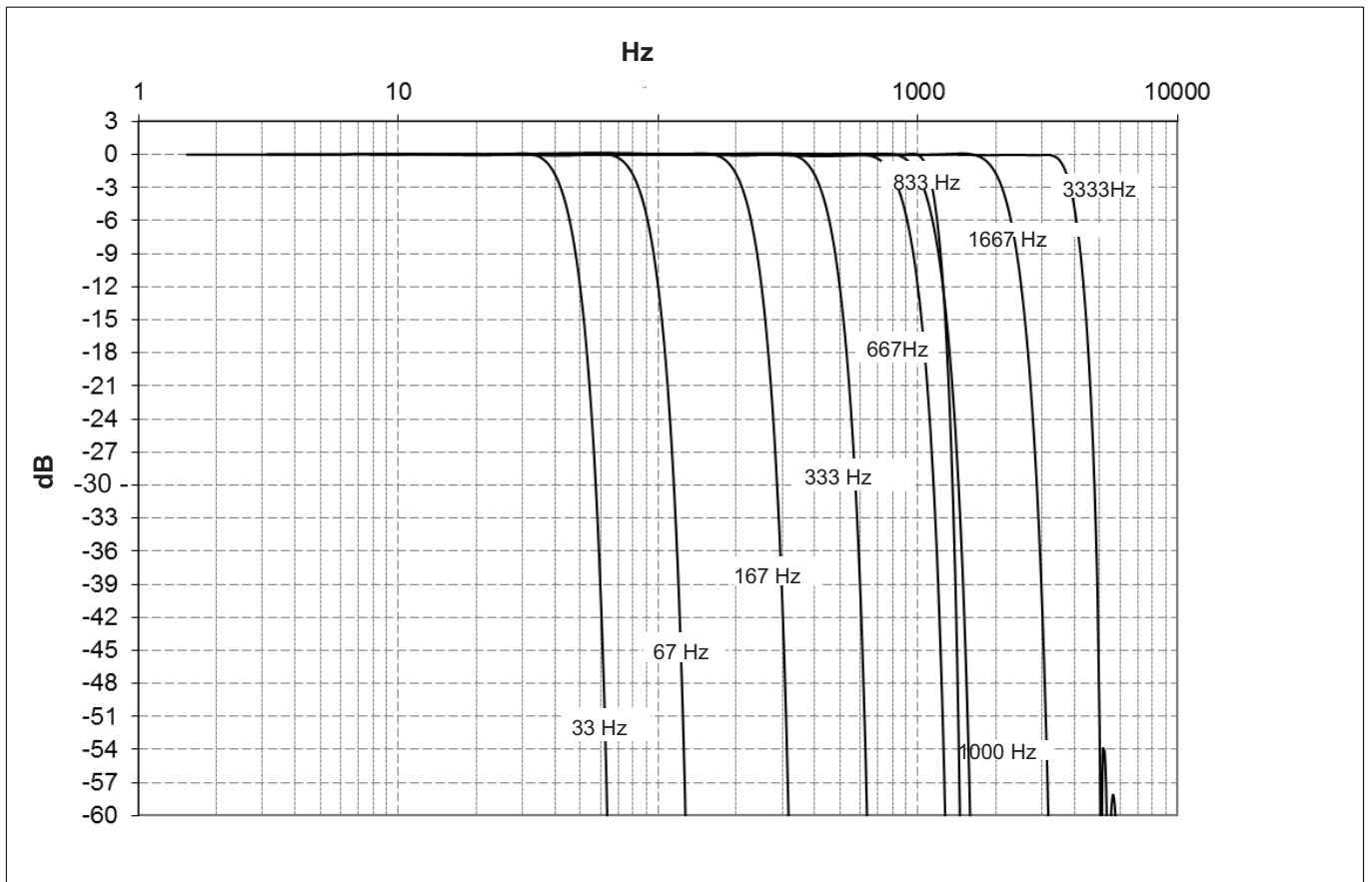



## DECIMAL SAMPLING RATES AND BUTTERWORTH DIGITAL LOW-PASS FILTERS

Type	Start of level drop	-3 dB (Hz)	-20 dB (Hz)	Runtime <sup>1)</sup> (ms)	Rise time (ms)	Overshoot (%)	Sampling rate (Hz)
Butterworth	1,384	1,500	1,887	3.47	0.353	18.7	10,000
	698	750	924	5.55	0.669	18.7	5,000
	344	370	471	14.1	1.40	18.7	2,500
	275	300	377	17.3	1.75	18.7	2,000
	140	150	185	27.6	3.41	18.7	1,000
	69	75	94	71.8	6.97	18.7	500
	28	30	37	139	17.0	18.7	200
	14	15	19	358	34.9	18.7	100

<sup>1)</sup> The A/D converter delay time for all sampling rates is 128 ms and this is not taken into account in the "runtime" column!  
 Also not included is the runtime of the analog anti-aliasing filter (160 µs). This means that 288 µs have to be added to the "runtime".

## DECIMAL SAMPLING RATES: BUTTERWORTH FILTER AMPLITUDE RESPONSE

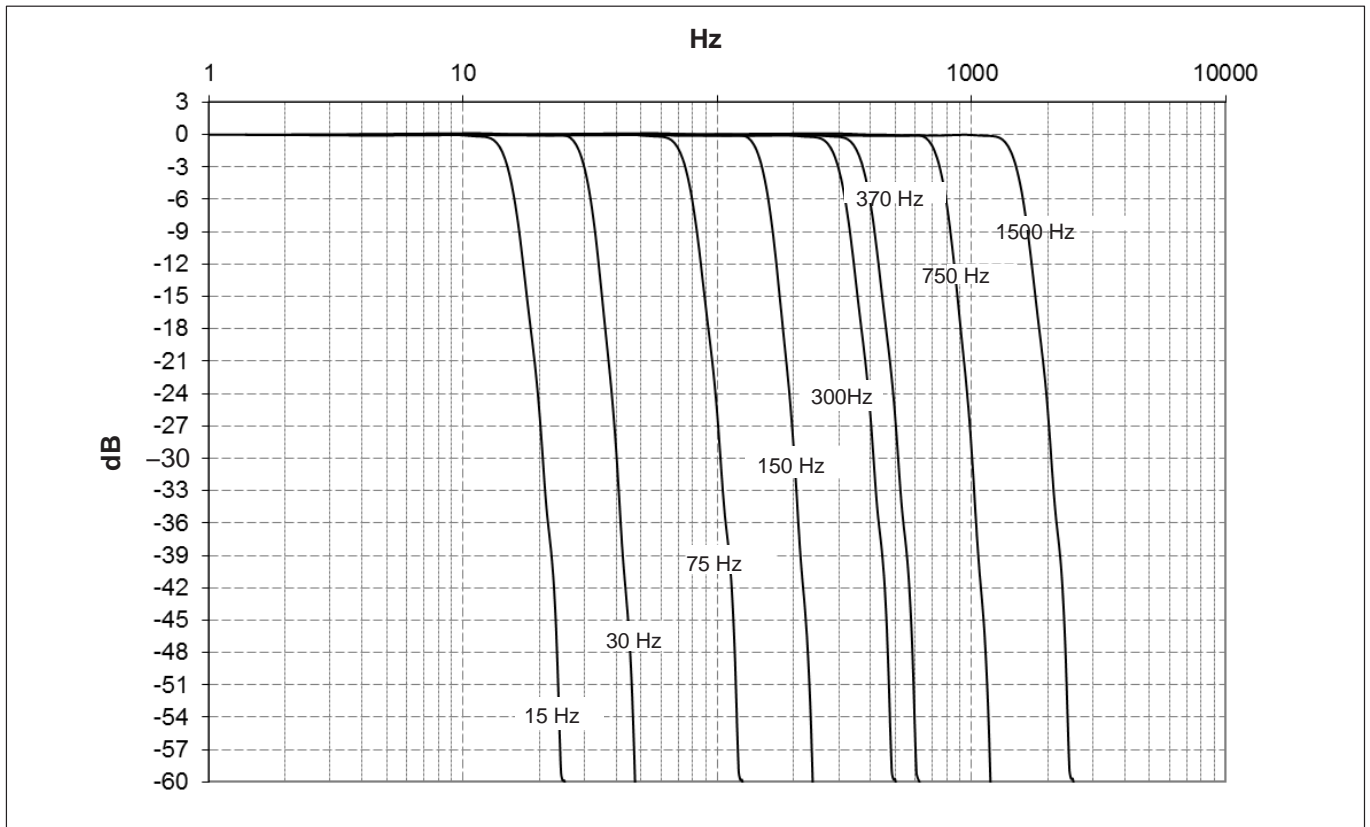

## CLASSIC HBM SAMPLING RATES AND DIGITAL LOW-PASS FILTERS, 4TH ORDER BESSEL

Type	-1 dB (Hz)	-3 dB (Hz)	-20 dB (Hz)	Runtime <sup>1)</sup> (ms)	Rise time (ms)	Overshoot (%)	Sampling rate (Hz)
Bessel	1,000	1,575	3,611	0.11	0.2	1.4	19,200
	500	812	2,079	0.3	0.38	1.3	9,600
	200	335	860	0.9	1.05	0.8	9,600
	100	168	427	1.8	2.11	0.8	9,600
	50	84	213	3.8	4.18	0.8	9,600
	20	33.7	85	9.6	10.4	0.8	9,600
	10	16.6	43	19.5	21.0	0.8	9,600
	5	8.4	21	39	41.4	0.8	2,400
	2	3.4	8.6	97	102	0.8	2,400
	1	1.6	4.2	197	215	0.8	2,400
	0.5	0.84	2.1	390	418	0.8	300
	0.2	0.34	0.85	980	1,033	0.8	300
	0.1	0.17	0.43	1,950	2,090	0.8	300
	0.05	0.085	0.21	3,660	4,170	0.8	20
	0.02	0.036	0.088	9,800	10,560	0.8	20
0.01	0.017	0.044	19,500	21,200	0.8	20	

1) The A/D converter delay time for all sampling rates is 128 ms and this is not taken into account in the "runtime" column!

## CLASSIC HBM SAMPLING RATES : BESSEL FILTER AMPLITUDE RESPONSE

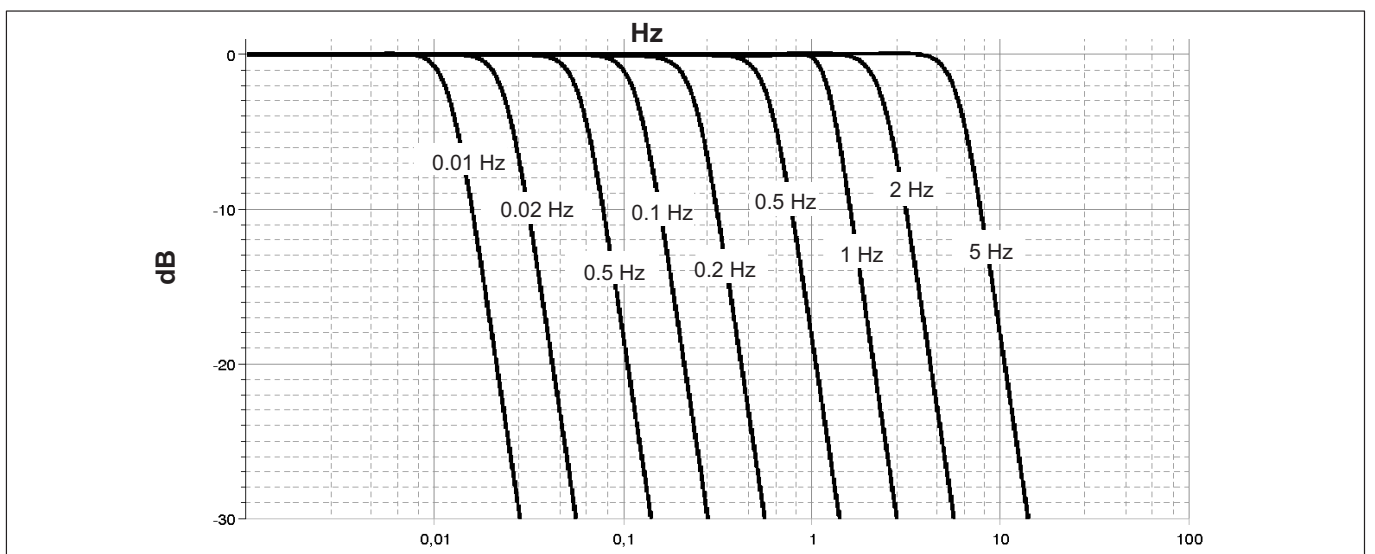
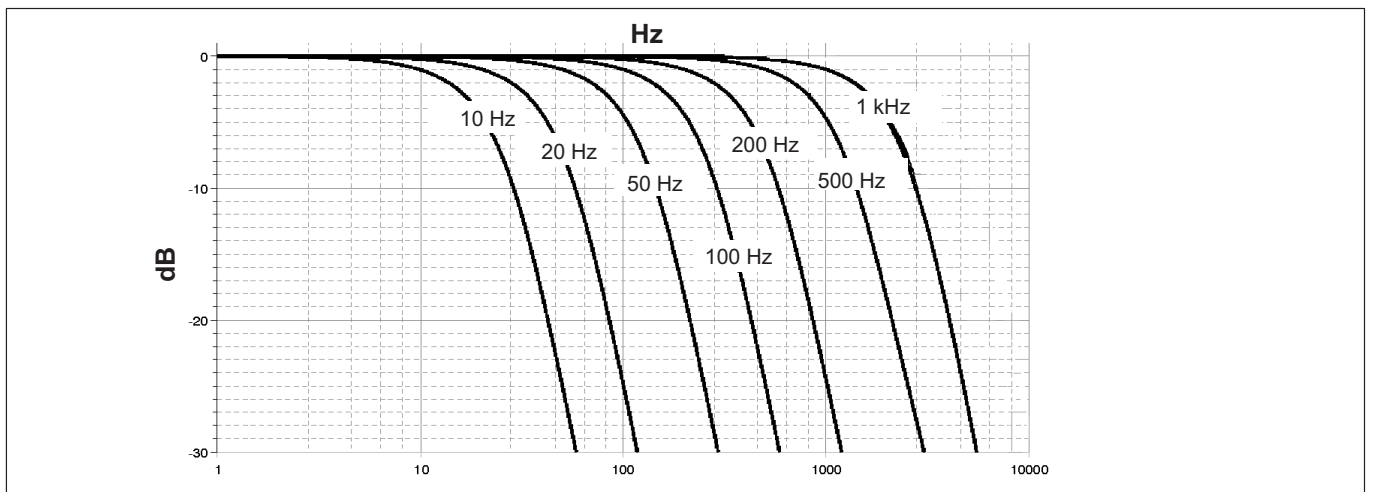

## CLASSIC HBM SAMPLING RATES AND DIGITAL LOW-PASS FILTERS, BUTTERWORTH

Type	-1 dB (Hz)	-3 dB (Hz)	-20 dB (Hz)	Runtime <sup>1)</sup> (ms)	Rise time (ms)	Overshoot (%)	Sampling rate (Hz)
Butterworth	2,000	3,053	5,083	0	0.144	8.5	19,200
	1,000	1,170	2,077	0.27	0.344	11	19,200
	500	587	1,048	0.64	0.652	11	9,600
	200	237	420	1.76	1.64	11	9,600
	100	118	210	3.65	3.28	11	9,600
	50	59	105	7.49	6.29	11	9,600
	20	24	42	18.8	16.15	11	9,600
	10	12	21	37.7	32.29	11	9,600
	5	5.95	10.5	74.9	65.92	11	2,400
	2	2.37	4.24	188	163.6	11	2,400
	1	1.26	2.12	370	315	11	2,400
	0.5	0.59	1.05	756	656	11	300
	0.2	0.241	0.419	1,900	1,640	11	300
	0.1	0.122	0.210	3,770	3,280	11	300
	0.05	0.060	0.106	7,490	6,596	11	20
	0.02	0.0245	0.042	18,900	16,200	11	20
0.01	0.012	0.021	37,700	32,383	11	20	

<sup>1)</sup> The A/D converter delay time for all sampling rates is 128 ms and this is not taken into account in the "runtime" column!

## CLASSIC HBM SAMPLING RATES : BUTTERWORTH FILTER AMPLITUDE RESPONSE

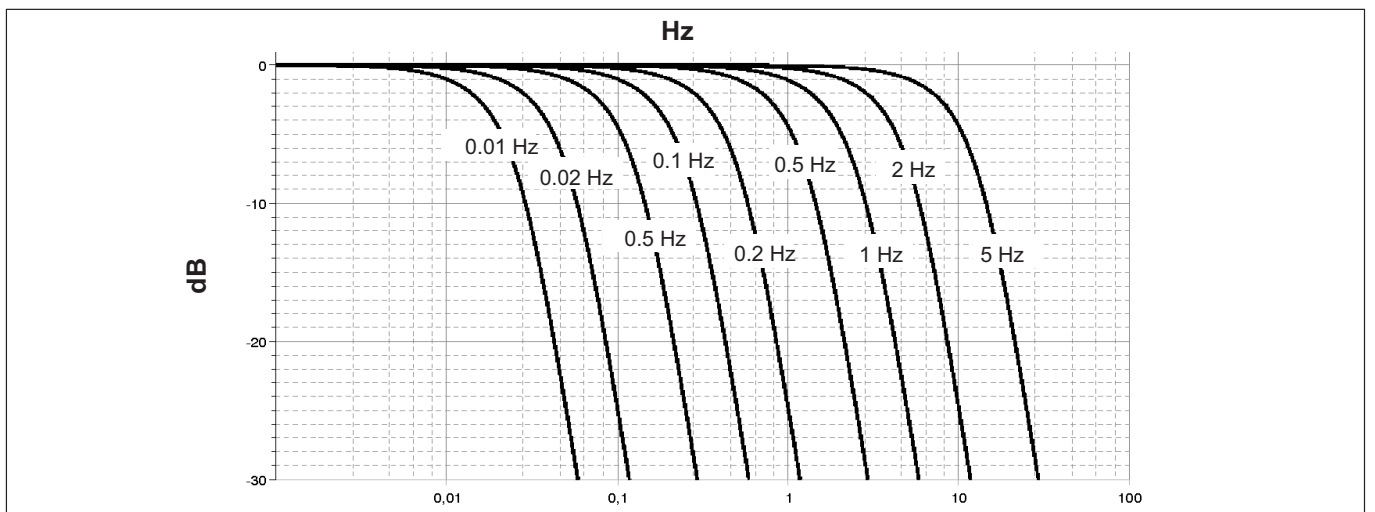
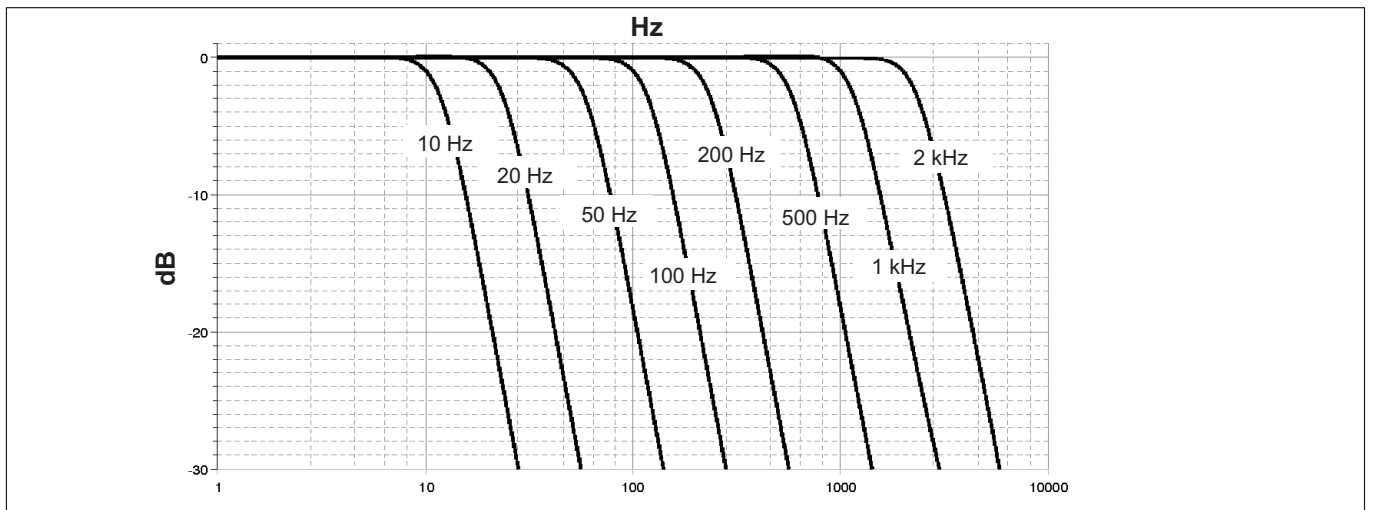



## SPECIFICATIONS NTX001 POWER SUPPLY

NTX001		
Nominal (rated) input voltage (AC)	V	100 ... 240 ( $\pm 10\%$ )
No-load power consumption at 230 V	W	0.5
<b>Nominal load</b>		
U <sub>A</sub>	V	24
I <sub>A</sub>	A	1.25
<b>Static output data</b>		
U <sub>A</sub>	V	24 $\pm$ 4 %
I <sub>A</sub>	A	0 / 1.25
U <sub>Br</sub> (output ripple voltage; peak-to-peak)	mV	$\leq$ 120
Current limiter, typically from	A	1.6
Galvanic isolation primary – secondary		electrical, by optocoupler and transducer
SG creep and clearances	mm	$\geq$ 8
High-voltage test	kV	$\geq$ 4
Ambient temperature	°C	0 ... +40
Storage temperature	°C	-40 ... +70

## ACCESSORIES, TO BE ORDERED SEPARATELY

Article	Description	Ordering number
<b>Power supply</b>		
AC-DC power supply / 24 V	Input: 100 ... 240 V AC ( $\pm 10\%$ ), 1.5 m cable Output: 24 V DC, max. 1.25 A, 2 m cable with ODU plug	1-NTX001
3 m cable - QuantumX supply	3 m cable to supply power to QuantumX modules; suitable plug (ODU Medi-Snap S11M08-P04MJGO-5280) at one end and exposed wires at the other.	1-KAB271-3
<b>Communication</b>		
Ethernet cable	Ethernet cable for direct operation between a PC or Notebook and a module / device, length 2 m, type CAT6A	1-KAB239-2
IEEE1394b FireWire cable (module-to-module)	FireWire connection cable for QuantumX or SomatXR-modules; with matching plugs on both sides. Length 0.2 m (angled) / 0.2 m / 2 m / 5 m Note: The cable enables modules to be supplied with power (max. 1.5 A, from the source to the last drain).	1-KAB272-W-0.2 1-KAB272-0.2 1-KAB272-2 1-KAB272-5
<b>Mechanical</b>		
Connecting elements for QuantumX modules	Connecting elements (clips) for QuantumX modules; Set comprising 2 case clips including mounting material for fast connection of 2 modules.	1-CASECLIP
Connecting elements for QuantumX modules	Fitting panel for mounting of QuantumX modules using case clips (1-CASECLIP), lashing strap or cable tie. Basic fastening by 4 screws.	1-CASEFIT
QuantumX Backplane (big)	QuantumX Backplane – for a maximum of 9 modules - Mounting on wall or control cabinet (19") - Connection of external modules by FireWire possible - Power supply: 18 ... 30 V DC / max. 5 A (150 W)	1-BPX001
QuantumX Backplane (Rack)	QuantumX Backplane - Rack for maximum 9 modules - 19" rack mounting with handles left and right - Connection of external modules via FireWire possible - Power supply: 18 ... 30 V DC / max. 5 A (150 W)	1-BPX002

Article	Description	Ordering number
QuantumX Backplane (small)	QuantumX Backplane - for a maximum of 5 modules - Connection of external modules by FireWire possible - Power supply: 11 ... 30 V DC / max. 5 A (90 W)	1-BPX003
<b>Transducer side</b>		
Push-in connectors (8 pins), gold	16 push-in connectors, Phönix Contact, 8 pins, gold	1-CON-S1015
Mounting aid for Push-in connector	Mounting aid for MX1601/15/16 Push-in connector suitable for 1-CON-S1015	1-WIRING-MATE
TEDS-Package 1 kb (5 pieces)	Package of TEDS chips, package consists of 5x 1-wire EEPROM DS28E07 (IEEE 1451.4 TEDS)	1-TEDS-PAK-B
TEDS-Package 4 kb (5 pieces)	Package of TEDS chips, package consists of 5x 1-wire EEPROM DS24B33 (IEEE 1451.4 TEDS)	1-TEDS-PAK
<b>Software and product packages</b>		
catman®AP 	All-inclusive package, comprising catman®Easy Functionality plus add-on modules such as video camera integration (EasyVideoCam), full post-process analysis (EasyMath), recurrent activity automation (EasyScript), measurement project preparation offline (EasyPlan), and additional functions such as electrical power calculation, special filters, and frequency spectrum. Details at <a href="http://www.hbm.com/catman/">www.hbm.com/catman/</a>	1-CATMAN-AP
catman®EASY 	This basic software package for data acquisition includes simple channel parameterization using TEDS or the sensor database, measurement job parameterization, individual visualization, data storage and reporting.	1-CATMAN-EASY
catman®PostProcess 	Post Process edition for visualization, analysis and processing of measurement data with many mathematical functions, data export and reporting.	1-CATEASY-PROCESS
LabVIEW™ driver <sup>1)</sup>	Universal driver from HBM for LabVIEW™.	1-LabVIEW-DRIVER
DIAdem® driver	QuantumX device driver for the DIAdem® software from National Instruments. German user interface.	1-DIADEM-DRIVER
CANape® driver	QuantumX device driver for CANape® software from Vector Informatik. CANape® version 10.0 and higher are supported.	1-CANAPE-DRIVER

1) Further drivers and partners at [www.hbm.com/quantumX/](http://www.hbm.com/quantumX/)