

# Strain Gauges

Absolute precision from HBM

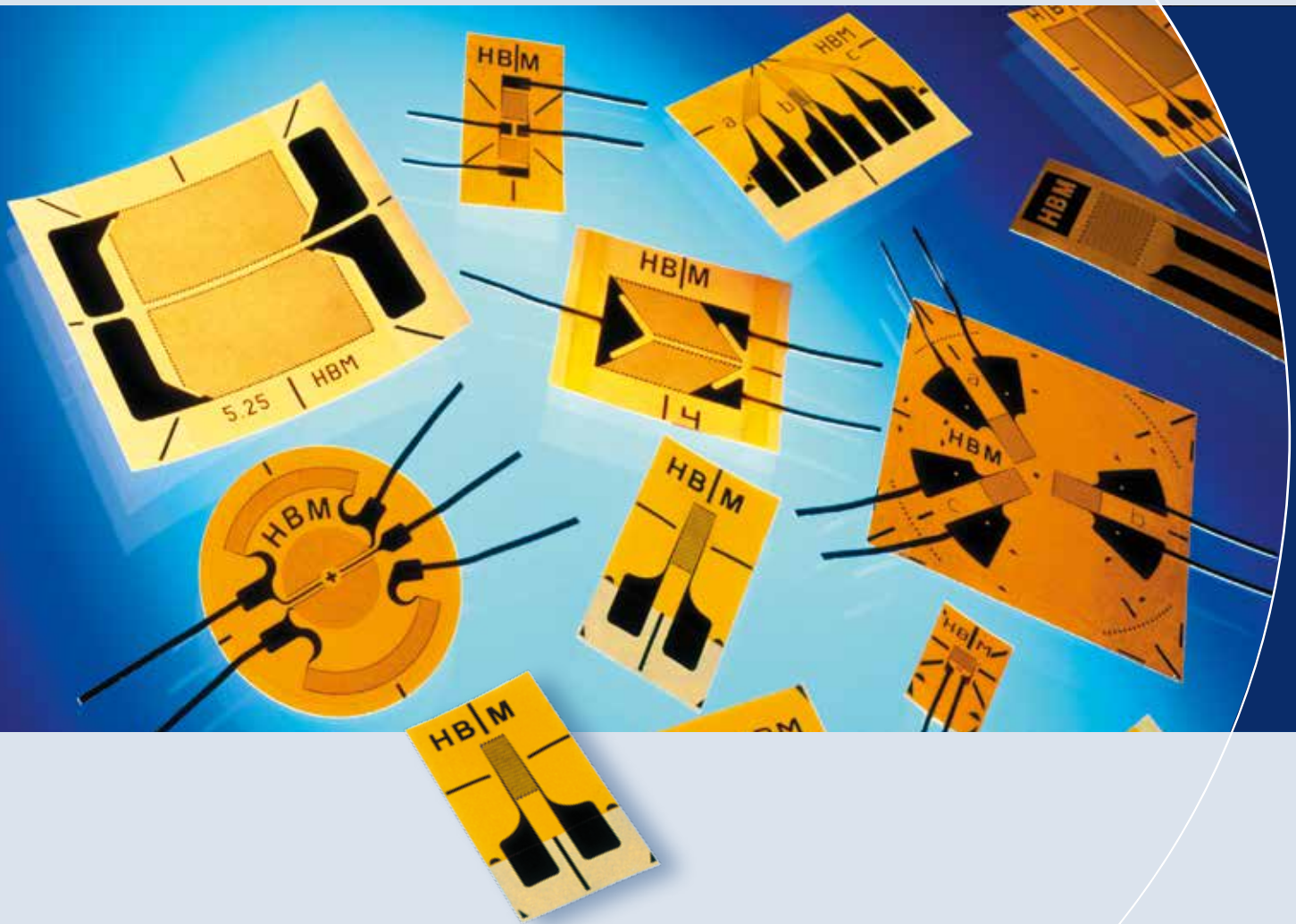



# Strain gauges

Absolute precision from HBM



# Table of contents

<b>Introduction</b>	6
Explanations on specifications	6
From measured strain to mechanical stress ...	12
The easy way to find the right strain gauge	14
Type coding	16
<b>SG in series Y</b>	18
Specifications	19
with 1 measuring grid / linear SG	20
with 2 measuring grids / double SG	24
with 2 measuring grids / T rosette	25
with 2 measuring grids / Shear/torsion SG / T rosette	27
with 2 measuring grids / Torsion/shear SG	28
with 3 measuring grids / rosettes	29
with 4 measuring grids / full bridges	33
with 4 measuring grids / diaphragm rosettes	34
SG chains	35
<b>SG with connection cable K-LY.../K-XY.../K-RY.../K-DY...</b>	39
Specifications	40
(incl. fluoropolymer-insulated wire) with 1 measuring grid	41
(incl. fluoropolymer-insulated wire) with 2 measuring grids	42
(incl. fluoropolymer-insulated wire) with 3 measuring grids	43
(incl. fluoropolymer-insulated wire) with double SG	44
SG with connection cable and RJ11 connector	44
<b>SG in series C</b>	45
Specifications	46
with 1 measuring grid	47
with 2 measuring grids, with 3 measuring grids	48
<b>SG in series G</b>	49
Specifications	50
with 1 measuring grid, 2 measuring grids	51

<b>SG in series V</b>	53
Encapsulated SG with 3m (10 ft) stranded connection wire	54
<b>Special SG</b>	55
Encapsulated SG with stranded wire	55
Weldable SG	56
SG for high strains	57
Strain gauges for integration in composites	58
Temperature sensor	59
Pressure measurement gauge	60
Crack propagation gauges	61
SG for determination of residual stress	63
MTS 3000	68
Integral hole drilling method	68
Customized strain gauges	69
<b>SG accessories</b>	70
SG fastening materials	70
Cleaning agents, gluing and soldering materials	75
Soldering terminals	76
Cables and stranded wires	77
Bridge completions/resin-cored solder/lead-free solder	80
SG installation case	81
<b>Amplifier Systems</b>	82
<b>Software</b>	84
<b>Optical strain gauges</b>	86
<b>Seminars</b>	87
<b>Literature</b>	88

# Explanations on specifications

## Strain gauge series

The HBM strain gauge range consists of the Y, C, G, V series and special strain gauges. There are different type series within each strain gauge series. Many specifications are identical for one strain gauge series; therefore, in this catalog, the specifications of a series are given on the pages preceding the list of individual strain gauges. Where the specifications of individual strain gauges differ from those stated for the other strain gauges of a series, these strain gauges are provided with a relevant note. The specifications and their tolerances are stated in compliance with OIML directive IR62, which is essentially identical to the VDI/VDE directive 2635.

## The specifications

have been determined according to OIML directive IR62. The tolerances are stated per OIML with double standard deviation. If the specified tolerance values of the gauge factor, transverse sensitivity, temperature coefficient, and temperature response are halved, the data complies with VDI/VDE directive 2635.

Below you will find further explanations regarding the terms used in the specifications tables.

## Connection configuration

HBM supplies strain gauges with different connection configurations.

Choose the configuration that best fits your application and personal preferences – the right connection for everyone.

### Integrated solder tabs, e.g. LY4

- allow direct soldering on the strain gauge



### Big solder tabs with strain relief, e.g. LY6

- allow comfortable soldering directly on the strain gauge, at the same time providing nearly full mechanical decoupling of solder tabs and strain gauges

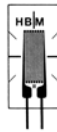
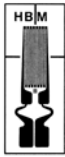

### Leads: Ni-plated copper leads; uninsulated; 30 mm (1.18 inch) long, e.g. LY1

- no direct soldering on the strain gauge
- for full mechanical decoupling of cables and strain gauge
- Use of separate solder terminals directly on the strain gauge required

### Fluoropolymer-insulated connection wires (50 mm (1.97 inch) long), e.g. K-LY4

- No soldering on the strain gauge
- Fluoropolymer insulation prevents the cable from sticking during installation
- Solder terminals near the strain gauge are required which are also used for the bridge connection

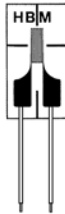

### PVC-insulated ribbon cable, alternatively with 2, 3 or 4-wire circuit; e.g. K-LY4

- Cable length as required (0.5 to 10 m (1.64 to 32.81 ft))
- Soldering at measurement point not required at all
- Fluoropolymer-insulated wire on the strain gauge prevents the cable from sticking during installation



## Strain gauge dimensions

The specified active measuring grid length "a" is the net length of the grid without the end loops (transverse bridges). If the following facts are taken into account, it is possible to cut the carrier foil: Cutting the foil in parallel to the measuring grid has only minor effects.

Shortening the carrier foil perpendicular to the measuring grid influences the way the strain is introduced, thereby also changing essential characteristics of the strain gauge. A minimum distance of 1mm (0.04 inch) between the measuring grid end and the end of the carrier foil should therefore be maintained.

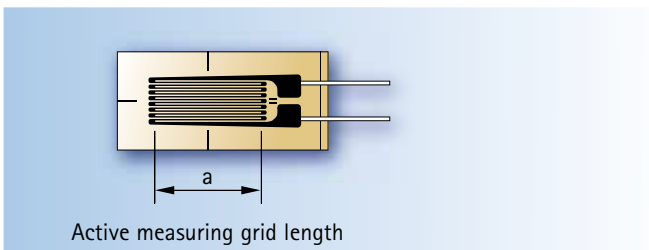

Schematic diagram of a strain gauge

## Strain gauge resistance

The electric resistance between the two metal leads, solder tabs or cable ends for connecting the measuring cable is called the resistance of a strain gauge.<sup>(1)</sup> Please note that the nominal resistance for strain gauges with connection cables<sup>(2)</sup> is specified without the cable.

HBM strain gauges are available with 120 Ohm, 350 Ohm, 700 Ohm or 1,000 Ohm resistance. The nominal resistance is stated on each strain gauge package including the resistance tolerance per package. HBM strain gauges are 100% resistance checked.

## Gage factor (strain sensitivity)

The strain sensitivity  $k$  of a strain gauge is the proportionality factor between the relative change in resistance  $\Delta R/R_0$  and the strain to be measured  $\varepsilon$ :  $\Delta R/R_0 = k \cdot \varepsilon$

The strain sensitivity yields a dimensionless number and is designated as gauge factor. This gauge factor is determined for each production batch by measuring and is specified on each strain gauge package as a nominal value complete with tolerance. The gauge factors vary between the production batches by just a few thousandths.

## Temperature coefficient of the gauge factor

The specified gauge factor applies at room temperature. It changes as the temperature changes; however, with an excellent approximation, this correlation is linear. In the case of constantan measuring grids (V, G, Y series) the gauge factor is proportional to temperature; in the case of chromium-nickel measuring grids (C series) the gauge factor is inversely proportional to temperature. The temperature coefficient of the gauge factor and its tolerance are stated on each strain gauge package.

<sup>(1)</sup> SG / V series, LE11

<sup>(2)</sup> see page 39 ff.

### Maximum permissible effective bridge excitation voltage

A strain gauge is a resistor, converting electrical energy into heat. To prevent heating of the strain gauge it is essential to choose a supply voltage that is not excessively high. The maximum permissible bridge excitation voltage is calculated for each strain gauge and is listed in a table in this catalog.

The specified excitation voltage always applies for the Wheatstone bridge as a whole. Only half the voltage may be applied to the individual strain gauge.

The maximum values specified are permissible only for application on materials featuring excellent heat conduction characteristics (e.g. steel of sufficient thickness).

Strain gauge measurements on plastic materials, and similar materials with poor heat conduction characteristics, require a reduction of the excitation voltage or switch-on period (impulse operation).

Also, with very low temperatures, the decreasing heat capacity of the materials may require a smaller excitation voltage.

### Reference temperature

The reference temperature is the ambient temperature to which the specifications of the strain gauge refer, unless no specific temperature ranges have been stated.

The specifications for the strain gauges are based on the reference temperature of  $23^{\circ}\text{C}$  ( $73.4^{\circ}\text{F}$ ).

### Transverse sensitivity

The transverse sensitivity is the ratio of the sensitivity of a strain gauge transverse to the measuring grid direction to its sensitivity in the measuring grid direction. The transverse sensitivity is stated on each strain gauge package.

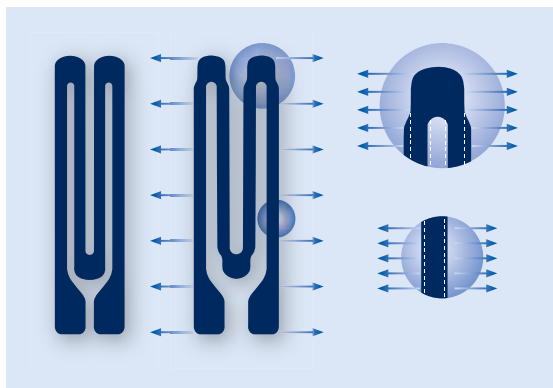

*Schematic diagram of the transverse sensitivity of a measuring grid*



## Operating temperature range

The operating temperature range is the range of ambient temperatures in which the strain gauge can be used without lasting changes in measurement properties occurring. There are different operating temperature ranges for absolute (with zero point reference) or relative (without zero point reference) measurements.

## Temperature response in a 1/4-bridge circuit

Strain gauges that are connected individually show an output signal, if the temperature changes. This signal is called "apparent strain" or "thermal output" and is independent of the mechanical load on the test object.

However, it is possible to adjust a strain gauge to the thermal expansion coefficient of a specific material such that the output signal is very small in the case of a temperature change. Such strain gauges are called strain gauges with "matched temperature response" or "self-compensated" strain gauges. All HBM strain gauges, with the exception of the LD20 high-strain gauge, are self-compensated.

To benefit from their matching to the temperature response, strain gauges must be selected according to the thermal expansion coefficient  $\alpha$  of the test material. Therefore HBM offers strain gauges for different materials. The code number for the temperature response matching is included in the strain gauge type name.

1	for ferritic steel	with $\alpha = 10.8 \cdot 10^{-6}/K$	( $6.0 \cdot 10^{-6}/^{\circ}F$ )
3	for aluminum	with $\alpha = 23 \cdot 10^{-6}/K$	( $12.8 \cdot 10^{-6}/^{\circ}F$ )
5	for austenitic steel	with $\alpha = 16 \cdot 10^{-6}/K$	( $8.9 \cdot 10^{-6}/^{\circ}F$ )
6	for quartz glass/composite	with $\alpha = 0.5 \cdot 10^{-6}/K$	( $0.3 \cdot 10^{-6}/^{\circ}F$ )
7	for titanium/gray cast iron	with $\alpha = 9 \cdot 10^{-6}/K$	( $5.0 \cdot 10^{-6}/^{\circ}F$ )
8	for plastic material	with $\alpha = 65 \cdot 10^{-6}/K$	( $36.1 \cdot 10^{-6}/^{\circ}F$ )
9	for molybdenum	with $\alpha = 5.4 \cdot 10^{-6}/K$	( $3.0 \cdot 10^{-6}/^{\circ}F$ )

Thus, for example, the types LY21 or RY31 (code number 1) have been matched to ferritic steel with  $\alpha = 10.8 \cdot 10^{-6}/K$ . The material to which the respective strain gauge has been matched is specified on the package with the applicable  $\alpha$ .

Despite this measure, a residual error remains, which is printed on the package in the form of a mathematical function and a graphical representation.

The effects of strain gauges using connection leads are also taken into account. This enables the apparent strain to be compensated by wiring and also mathematically.

The temperature response involves a tolerance and only applies in the temperature range of the temperature response matching. This temperature range is specified in the specifications of the individual series in this catalog.

Another possibility of compensating the apparent strain is to use appropriate wiring (e.g. circuit with compensating strain gauge, half bridge circuit, etc.).

### **Mechanical hysteresis**

The mechanical hysteresis of a strain gauge is defined as the difference of the measured value displayed for increasing and decreasing strain loadings with the same strain value on the specimen. Hysteresis is not only dependent on the strain gauge but to a major extent it is also dependent on application parameters such as type and layer thickness of the adhesive, etc. For this reason, the specifications include hysteresis values for different installation parameters.

### **Maximum elongation**

The maximum elongation of a strain gauge is the strain where the characteristic curve (resistance change-strain characteristic) deviates by more than  $\pm 5\%$  from the mean characteristic curve of the type. This is often the case if the installation or the strain gauge has been damaged.

## Minimum radius of curvature

The flexibility of a strain gauge is characterized by the minimum radius of curvature which it will withstand, without any auxiliary measures, in each direction respectively. The polyimide carriers of Y and C series strain gauges are flexible to an extent that they can be bonded around edges. Although the carrier materials of the other strain gauge series are more brittle, they can also be easily prepared for application to smaller radii by thermal pre-forming. Exception: V series strain gauges have a bigger radius of curvature because of their specific potting.

## Fatigue life

If a strain gauge is subjected to an alternating strain which can be superimposed over a static mean strain, an increase in the number of load cycles may create changes with regard to the zero point. The fatigue life is dependent upon the number of strain cycles and their amplitude and is independent of applied strain duration.

The achievable load cycle values are also dependent on the various installation parameters and are therefore only given for representative examples.

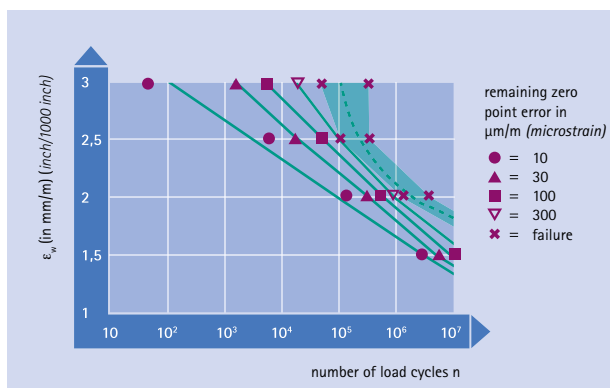

Example diagram of the fatigue life of strain gauges

## Applicable bonding materials

For each strain gauge series, the relevant bonding materials are specified. With regard to bonding technique, the HBM range of accessories distinguishes among cold and hot curing adhesives as well as spot welding methods. One of the most important selection criteria is the application temperature range of the individual bonding materials.

# From measured strain to mechanical stress ...

## Analysis of the biaxial stress state with unknown principal directions

The principle of experimental stress analysis using strain gauges (SG) consists in using strain gauges to measure strains on the component surface.

From these measured strains and the known material properties (modulus of elasticity and Poisson's ratio), the absolute value and the direction of these mechanical stresses are determined. These calculations are based on Hooke's Law which applies to the elastic deformation range of linear-elastic materials.

In experimental stress analysis, so-called 3-grid rosettes are used for strain measurement. These are available in 0°/45°/90° and 0°/60°/120° versions. Both forms have a historical background.

It is up to the user to choose which version to use.

The 3 measuring grids of the rosettes are designated with the letters a, b and c. Therefore, a 3-grid rosette measures the three strains  $\varepsilon_a$ ,  $\varepsilon_b$  and  $\varepsilon_c$ .

The principal normal stresses  $\sigma_1$  and  $\sigma_2$  are calculated for the 0°/45°/90° rosette using the formula:

$$\sigma_{1/2} = \frac{E}{1-\nu} \cdot \frac{\varepsilon_a + \varepsilon_c}{2} \pm \frac{E}{\sqrt{2}(1+\nu)} \cdot \sqrt{(\varepsilon_a - \varepsilon_b)^2 + (\varepsilon_c - \varepsilon_b)^2}$$

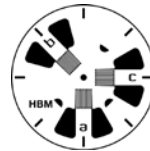

0°/45°/90° rosette  
e.g. RY3x

and for the 0°/60°/120° rosette:

$$\sigma_{1/2} = \frac{E}{1-\nu} \cdot \frac{\varepsilon_a + \varepsilon_b + \varepsilon_c}{3} \pm \frac{E}{1+\nu} \cdot \sqrt{\left(\frac{2\varepsilon_a - \varepsilon_b - \varepsilon_c}{3}\right)^2 + \frac{1}{3}(\varepsilon_b - \varepsilon_c)^2}$$

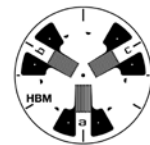

0°/60°/120° rosette  
e.g. RY7x

The principal directions are determined below. First the tangent of an auxiliary angle  $\psi$  is calculated.

For the  $0^\circ/45^\circ/90^\circ$  rosette using the formula:

$$\tan \psi = \frac{2\varepsilon_b - \varepsilon_a - \varepsilon_c}{\varepsilon_a - \varepsilon_c} \quad \left| \quad \frac{Z}{N}\right.$$

and for the  $0^\circ/60^\circ/120^\circ$  rosette according to the formula:

$$\tan \psi = \frac{\sqrt{3}(\varepsilon_b - \varepsilon_c)}{2\varepsilon_a - \varepsilon_b - \varepsilon_c} \quad \left| \quad \frac{Z}{N}\right.$$

Note: The tangent of an angle in the right-angled triangle is the ratio of the opposite side (numerator N) to the adjacent side (denominator D):

$$\tan \psi = \frac{\text{Opposite side}}{\text{Adjacent side}} = \frac{Z}{N}$$

This ambiguity of the tangent makes it necessary to determine the signs of the numerator (N) and the denominator (D) before carrying out the final calculation of the two above mentioned quotients. Determining the signs is important because they alone indicate the quadrant of the circular arc in which the angle  $\psi$  is located.

From the value of the tan, the value of the intermediate angle  $\psi$  must first be determined:

$$|\psi| = \arctan [^\circ]$$

Then the angle  $\varphi$  should be determined using the following scheme:

$$\left. \begin{array}{l} Z \geq 0 (+) \\ N > 0 (+) \end{array} \right\} \varphi = \frac{1}{2}(0^\circ + |\psi|)$$

$$\left. \begin{array}{l} Z > 0 (+) \\ N \leq 0 (-) \end{array} \right\} \varphi = \frac{1}{2}(180^\circ - |\psi|)$$

$$\left. \begin{array}{l} Z \leq 0 (-) \\ N < 0 (-) \end{array} \right\} \varphi = \frac{1}{2}(180^\circ + |\psi|)$$

$$\left. \begin{array}{l} Z < 0 (-) \\ N \geq 0 (+) \end{array} \right\} \varphi = \frac{1}{2}(360^\circ - |\psi|)$$

The angle  $\psi$  found in this manner should be applied from the axis of the reference measuring grid a in the mathematically positive direction (counterclockwise). The axis of the measuring grid a forms one arm of the angle  $\psi$ . The other arm represents the first principal direction. This is the direction of the principal normal stress  $\sigma_1$  (identical with the principal strain direction  $\varepsilon_1$ ). The point of the angle is located at the intersection of the axes of the measuring grids. The second principal direction (direction of the principal normal stress  $\sigma_2$ ) has the angle  $\varphi + 90^\circ$ .

# The easy way to find the right strain gauge

## Geometry of the strain gauge

The geometry of the strain gauge depends on the measurement task to be solved

### Linear strain gauges (e.g. LY1), one measuring grid

Typical application:

- Strain measurement in one direction

### T rosettes with two measuring grids (e.g. XY1), offset by 90°

Typical applications:

- Analysis of the biaxial stress state with known principal directions
- Measurements on tension/compression bars

For more detailed information see 1) and 2)

### V-shaped strain gauges (e.g. XY2), 2 measuring grids, arranged at $\pm 45^\circ$ relative to the SG axis

Typical applications:

- Measurements on torsion bars
- Determination of shear stresses occurring in shear beams around the neutral fiber

For more detailed information see 1) and 2)

### Rosettes with three measuring grids (e.g. RY8), $0^\circ/45^\circ/90^\circ$ or $0^\circ/60^\circ/120^\circ$ arrangement

Typical application:

- Analysis of the biaxial stress state with unknown principal stress directions

The three measuring grids are arranged in a so-called quarter bridge circuit.

The absolute value and the direction of the first and second principal stress are computed as described on page 12.

For more detailed information see 2)

### Double SG with two measuring grids (e.g. DY1),

arranged in parallel

Typical application:

- Measurement on bending beams

For more detailed information see 1) and 2)

### Full bridge strain gauges (e.g. VY4), 4 measuring grids,

offset by 90° relative to each other

Typical applications:

- Measurements on tension/compression bars
- Measurements on torsion bars
- Determination of shear stresses occurring in shear beams around the neutral fiber

For more detailed information see 1) and 2)

### Strain gauge chains (e.g. KY1), 10 or 15 very small measuring grids, arranged

equidistantly on a common carrier, plus one compensating SG

Typical application:

- Determination of strain gradients.

HBM also supplies strain gauge chains complete with several rosettes and alternating measuring grid directions so that it is even possible to determine the gradient of a biaxial stress state.

For more detailed information see 2)

### Diaphragm rosettes (e.g. MY1), 4 measuring grids

Typical applications:

- Manufacture of diaphragm pressure transducers

1) Brochure "Using the Wheatstone bridge circuit" (free)

2) Book: "An Introduction to Measurements Using Strain Gauges"

## SG measuring grid length

The strain gauge measuring grid length depends on aim of measurement, as the result of a measurement using strain gauges will be the mean strain underneath the measuring grid.

In general, measuring grid lengths of 3 or 6 mm (*0.118 or 0.236 inch*) represent a good solution.

**Long measuring grids** are recommended where there is an inhomogeneous material such as e.g. concrete or wood.

A long strain gauge will bridge the inhomogeneities of the work piece and, as a measurement result, will supply the strain underneath the measuring grid.

**Short measuring grids** are suitable for detecting a local strain state. They are therefore suitable for determining strain gradients (see strain gauge chains), the maximum point of notch stresses and similar stresses.

## SG series

The HBM strain gauge range comprises various type series for the following typical applications:

**Y SG:** The universal strain gauge for stress analysis and "simple" transducers. Easy to handle, robust, flexible, many geometries and nominal (rated) resistances available.

Measuring grid: Constantan; Measuring grid carrier: Polyimide

**C SG:** For measurements at extreme temperatures; operating temperature range from  $-269\text{... up to }+250^\circ\text{C}$  ( $-452^\circ\text{F... up to }+482^\circ\text{F}$ ); temperature response with matching in the range of  $-200\text{... }+250^\circ\text{C}$  ( $-328^\circ\text{F... }+482^\circ\text{F}$ ).

Measuring grid: Cr-Ni alloy; Measuring grid carrier: Polyimide

**G SG:** For the manufacture of transducers, nominal (rated) resistances of 120  $\Omega$  and 350  $\Omega$  available

Measuring grid: Constantan; Measuring grid carrier: phenolic resin, glass fiber reinforced.

**V SG:** Encapsulated strain gauges for experimental stress analysis.

Measuring grid: Constantan; Measuring grid carrier: polyimide with potting made of special plastic material and 3 m (*9.84 ft*) stranded wire.

## SG resistance

HBM strain gauges are available in 120, 350, 700 and 1,000 Ohm versions.

The selection of the resistance depends on the constraints of the measurement task. Other resistances on request.

### 120 ohm strain gauges:

- + Relative insensitivity to variations in insulation resistance, e.g. caused by effects of humidity.

### High ohm strain gauges:

- + Less specific heat because of their lower measurement current
- + Less sensitive to ohmic resistances in the connection lines to the measurement amplifier.
- Better "antennae" for reception of noise pulses.

Select the right strain gauge in the application experimental stress analysis

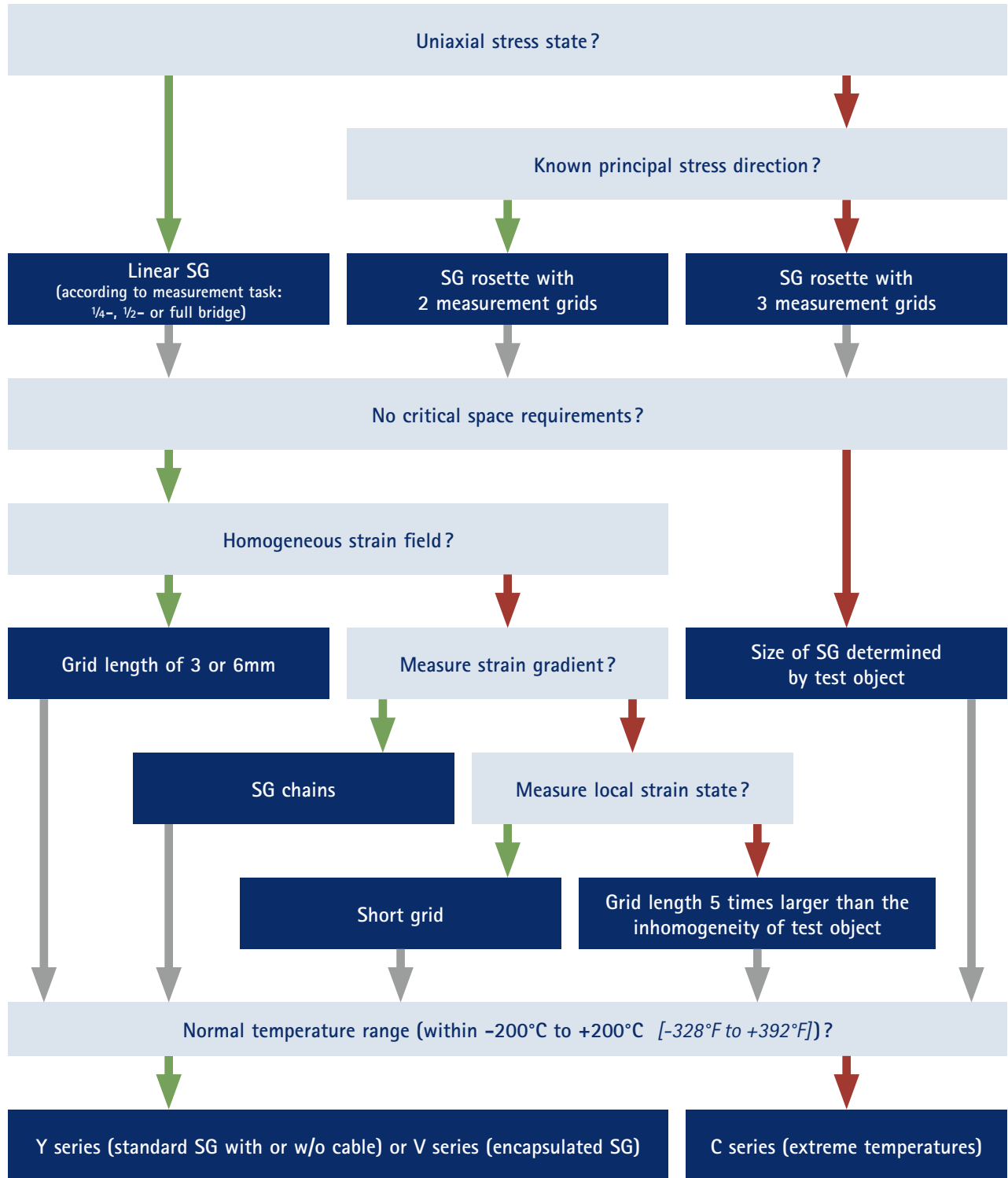

Note: If you are looking for strain gauges to be used in the construction of transducers, please refer to our catalog "Strain gauges for transducer manufacturers" with specialized strain gauge series.



YES



NO

# Type coding

1 - L Y 1 1 - 3 / 120 A

Options<sup>(1)</sup>: A = Application aid  
V = Four wire connection  
Z = Two wire connection

Measuring grid resistance in ohms

Measuring grid length in mm

- For RY1, RY3, RY4, RY7:  
Diameter of circle which surrounds the measuring grid
- For SG chains: Distance of measuring grid centers relative to each other (pitch)

**Material to which the SG temperature response is matched:** If, at this position, you find the placeholder "x", replace it with the code number for the temperature response matching of your choice.

1 ferritic steel	mit $\alpha = 10.8 \cdot 10^{-6}/K$ ( $6.0 \cdot 10^{-6}/^{\circ}F$ )
3 aluminium	mit $\alpha = 23 \cdot 10^{-6}/K$ ( $12.8 \cdot 10^{-6}/^{\circ}F$ )
5 austenitic steel	mit $\alpha = 16 \cdot 10^{-6}/K$ ( $8.9 \cdot 10^{-6}/^{\circ}F$ )
6 quartz glass/composite	mit $\alpha = 0.5 \cdot 10^{-6}/K$ ( $0.3 \cdot 10^{-6}/^{\circ}F$ )
7 titanium /gray cast iron	mit $\alpha = 9 \cdot 10^{-6}/K$ ( $5.0 \cdot 10^{-6}/^{\circ}F$ )
8 plastic material	mit $\alpha = 65 \cdot 10^{-6}/K$ ( $36.1 \cdot 10^{-6}/^{\circ}F$ )
9 molybdenum	mit $\alpha = 5.4 \cdot 10^{-6}/K$ ( $3.0 \cdot 10^{-6}/^{\circ}F$ )

Layout of grids, type and position of the connections

**SG series**

C series = Carrier and cover: Polyimide / Measuring grid foil Chromium/nickel alloy

Y series = Carrier and cover: Polyimide / Measuring grid foil Constantan

G series = Carrier and cover: Glass-fiber reinforced phenolic resin /  
Measuring grid foil: Constantan

V series = Carrier: Polyimide/Measuring grid foil: Constantan,

Molded with special plastic material, 3 m (9.84 ft) stranded wire as standard

**Number of measuring grids and their relative positions to each other**

L	= one measuring grid, linear SG
D	= two measuring grids, measuring grid direction: parallel
X	= two measuring grids, measuring grid direction: T or X-shaped, offset by 90°
R	= three measuring grids, rosettes
V	= 4 measuring grids, full bridge SG
M	= full bridge SG as diaphragm rosette
K	= SG chains for determining strain gradients

**Standard or configurable**

1	= Standard
K	= with freely configurable connection cables

<sup>(1)</sup> available for selected strain gauge types only



### An even greater range of types – Easy to order

The current catalog offers a great selection of strain gauges (SG). In addition to our wide range of preferential strain gauges (available ex stock), we hold a comprehensive choice of variants available for you.

### This is how easily you can order our strain gauges

Types available ex stock are printed on a shaded background in our price list. Strain gauge variants do not have a shaded background and are not always available ex stock.

We will be pleased to provide information on current availability if requested. The minimum order quantity for these strain gauges is 3 packages.

### What does the "x" in the type designation of the strain gauges in the "Variants" column stand for?

Types available ex stock		Variants	No-minal resistance	Dimensions (mm/inch)				Max. perm. effective bridge ex. voltage	Solder terminals
Steel	Aluminum			Other	Ω	Measuring grid			
		a	b			c	d	V	
1-LY11-0.6/120	1-LY13-0.6/120		120	0.6 0.024	1 0.039	5 0.197	3.2 0.126	1.5	LS 7
1-LY11-1.5/120	1-LY13-1.5/120		120	1.5 0.059	1.2 0.047	6.5 0.256	4.7 0.185	2.5	LS 7
1-LY11-3/120	1-LY13-3/120	1-LY1x-3/120	120	3 0.118	1.4 0.055	8.5 0.335	4.5 0.177	4	LS 7
1-LY11-3/120A		1-LY1x-3/120A	120	3 0.118	1.4 0.055	8.5 0.335	4.5 0.177	4	LS 7
1-LY11-6/120	1-LY13-6/120		120	6 0.236	2.8 0.11	13 0.512	6 0.236	8	LS 5
1-LY11-6/120A		1-LY1x-6/120A	120	6 0.236	2.8 0.11	13 0.512	6 0.236	8	LS 5
1-LY11-10/120	1-LY13-10/120	1-LY1x-10/120	120	10 0.394	4.9 0.193	18.5 0.728	9.5 0.374	13	LS 5
1-LY11-10/120A		1-LY1x-10/120A	120	10 0.394	4.9 0.193	18.5 0.728	9.5 0.374	13	LS 5
1-LY11-1.5/350	1-LY13-1.5/350		350	1.5 0.059	1.2 0.047	5.7 0.224	4.7 0.185	4.5	LS 212
1-LY11-3/350	1-LY13-3/350		350	3 0.118	1.5 0.059	8.5 0.335	4.5 0.177	7	LS 7
		1-LY1x-3/350A	350	3 0.118	1.5 0.059	8.5 0.335	4.5 0.177	7	LS 7
1-LY11-6/350	1-LY13-6/350		350	6 0.236	2.9 0.114	13 0.512	6 0.236	14	LS 5
1-LY11-6/350A		1-LY1x-6/350A	350	6 0.236	2.9 0.114	13 0.512	6 0.236	14	LS 5
1-LY11-10/350		1-LY1x-10/350	350	10 0.394	5 0.197	18.5 0.728	9.5 0.374	23	LS 5
1-LY11-10/350A		1-LY1x-10/350A	350	10 0.394	5 0.197	18.5 0.728	9.5 0.374	23	LS 5

Instead of the "x" in the strain gauge type designation in the "Other" column, please enter the code number for the appropriate temperature response matching.

#### Example:

You wish matching of the type 1-LY1x-10/120 to plastic material. Then enter an "8" instead of the placeholder "x" when ordering; the exact order designation will then be 1-LY18-10/120.

The preferential strain gauges are matched to steel or aluminum.

Please note the exceptions in the case of types marked by (#)!

To simplify your order procedures, please use our HBM online shop!  
[www.hbm.com/HBMshop](http://www.hbm.com/HBMshop)

## SG in series Y

- The universal SG
- Excellent measuring characteristics
- Different connection configurations
- Strain gauge with connection cable (Page 39)
- Flexible, therefore easy to handle
- Wide range of geometries available ex stock
- Numerous geometries are available with different nominal (120, 350, 700, 1,000  $\Omega$ ) resistance values

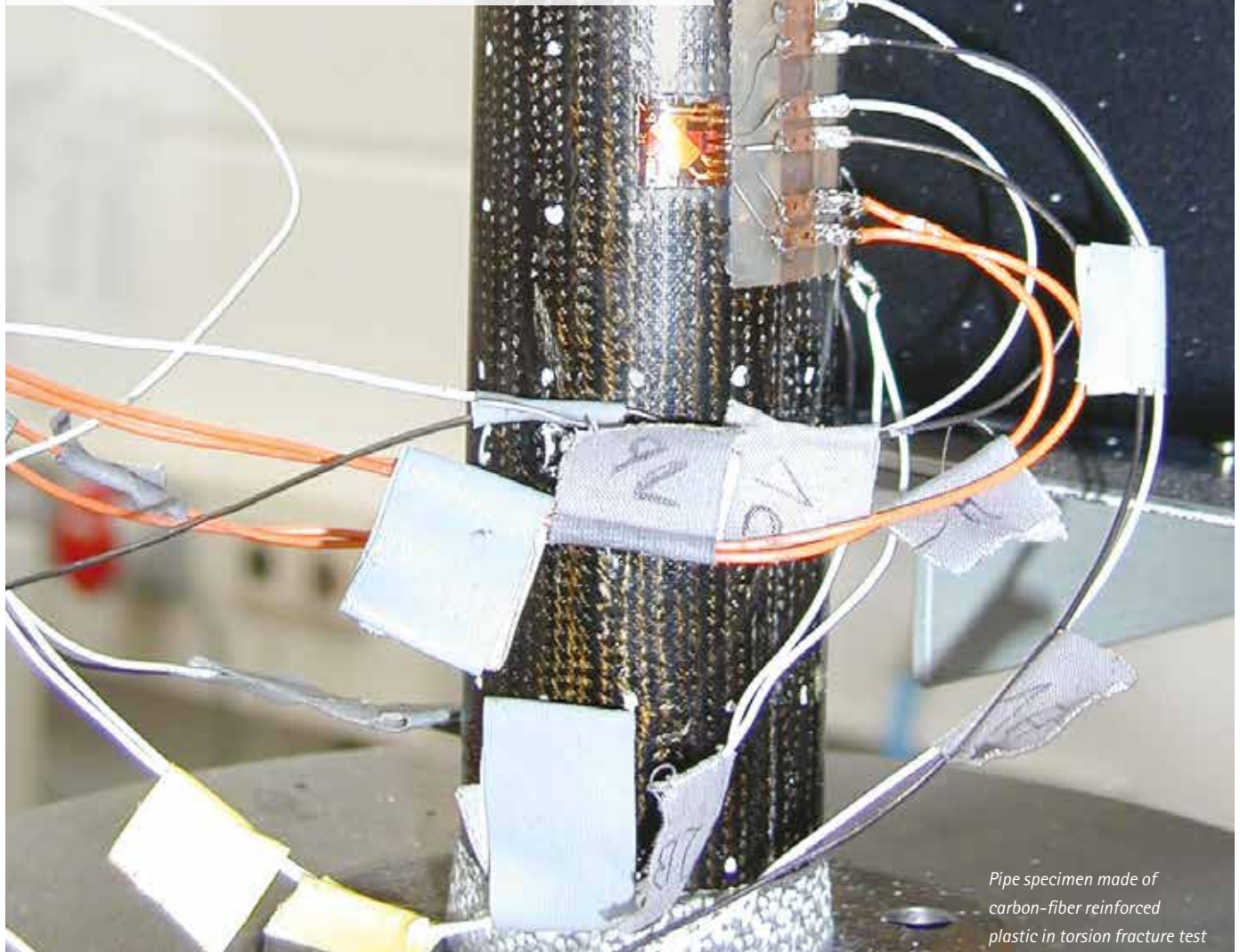

*Pipe specimen made of carbon-fiber reinforced plastic in torsion fracture test*

## Specifications – Series Y

SG construction		Foil SG with embedded measuring grid
Measuring grid		Constantan foil
Material	$\mu\text{m}$ (microinch)	approx. 3.8 or 5 (150 or 197), depending on SG type
Thickness		
Carrier		Polyimide
Material	$\mu\text{m}$ (microinch)	45 ± 10 (1.772 ± 394)
Thickness		
Covering agent		Polyimide
Material	$\mu\text{m}$ (microinch)	25 ± 12 (984 ± 472)
Thickness		
Connections		Nickel plated Cu leads, approx. 30 mm long
length without connection leads		Integrated solder tabs, approx. 1.5 mm long, approx. 1.6 ... 2.2 mm (0.063 ± 0.087 inch) wide Solder tabs with strain relief made of copper-beryllium
Nominal resistance	$\Omega$	120, 350, 700 or 1,000, depending on SG type
Resistance tolerance <sup>(2)</sup>	%	± 0.3 without; ± 0.35 with connection leads
Gage factor		approx. 2
Nominal value of gage factor		Specified on each package
Gage factor tolerance with $\leq 1.5$ mm (0.059 inch) measuring grid length	%	± 1.5
with $\geq 3$ mm (0.118 inch) measuring grid length	%	± 1
Temperature coefficient of the gage factor	1/K (1/°F)	approx. (115 ± 10) · 10 <sup>-6</sup> ((64 ± 5.5) · 10 <sup>-6</sup> )
Nominal value of gage factor temperature coefficient		Specified on each package
Reference temperature	°C (°F)	23 (73.4)
Operating temperature range		
for static, i.e. zero point-related measurements	°C (°F)	-70 ... +200 (-94 ... +392)
for dynamic, i.e. non-zero point-related measurements	°C (°F)	-200 ... +200 (-328 ... +392)
Transverse sensitivity		Specified on each package
at reference temperature when using Z70 adhesive	%	- 0.1
on SG type LY11-6/120		
Temperature response		Specified on each package
Temperature response as required, adapted to coefficients of thermal expansion		
$\alpha$ for ferritic steel	1/K (1/°F)	10.8 · 10 <sup>-6</sup> (6.0 · 10 <sup>-6</sup> )
$\alpha$ for aluminum	1/K (1/°F)	23 · 10 <sup>-6</sup> (12.8 · 10 <sup>-6</sup> )
$\alpha$ for plastic material	1/K (1/°F)	65 · 10 <sup>-6</sup> (36.1 · 10 <sup>-6</sup> )
$\alpha$ for austenitic steel	1/K (1/°F)	16 · 10 <sup>-6</sup> (8.9 · 10 <sup>-6</sup> )
$\alpha$ for titanium	1/K (1/°F)	9 · 10 <sup>-6</sup> (5.0 · 10 <sup>-6</sup> )
$\alpha$ for molybdenum	1/K (1/°F)	5.4 · 10 <sup>-6</sup> (3.0 · 10 <sup>-6</sup> )
$\alpha$ for quartz glass / composite	1/K (1/°F)	0.5 · 10 <sup>-6</sup> (0.3 · 10 <sup>-6</sup> )
Tolerance of temperature response	1/K (1/°F)	± 0.3 · 10 <sup>-6</sup> (± 0.17 · 10 <sup>-6</sup> )
Temperature response with matching in the range of <sup>(3)</sup>	°C (°F)	-10 ... +20 (14 ... 248)
Mechanical hysteresis <sup>(1)</sup>		
at reference temperature and strain $\varepsilon = \pm 1,000 \mu\text{m}/\text{m}$ (microstrain)		
on SG type LY11-6/120		
at 1st load cycle and adhesive Z 70	$\mu\text{m}/\text{m}$ (microstrain)	1
at 3rd load cycle and adhesive Z 70	$\mu\text{m}/\text{m}$ (microstrain)	0.5
at 1st load cycle and adhesive X 60	$\mu\text{m}/\text{m}$ (microstrain)	2.5
at 3rd load cycle and adhesive X 60	$\mu\text{m}/\text{m}$ (microstrain)	1
Maximum elongation <sup>(1)</sup>		
at reference temperature using adhesive Z 70		
on SG type LY11-6/120		
Absolute strain value $\varepsilon$ for positive direction	$\mu\text{m}/\text{m}$ (microstrain)	50,000 (± 5 %)
Absolute strain value $\varepsilon$ for negative direction	$\mu\text{m}/\text{m}$ (microstrain)	50,000 (± 5 %)
Fatigue life <sup>(1)</sup>		
at reference temperature using adhesive X 60		
on SG type LY61-6/120		
Achievable number of load cycles $L_w$ at		
alternating strain $\varepsilon_w = \pm 1,000 \mu\text{m}/\text{m}$ and zero point drift $\varepsilon_m \Delta \leq 300$	$\mu\text{m}/\text{m}$ (microstrain)	>> 10 <sup>7</sup> (test was interrupted at 10 <sup>7</sup> )
$\varepsilon_m \Delta \leq 30$	$\mu\text{m}/\text{m}$ (microstrain)	> 10 <sup>7</sup> (test was interrupted at 10 <sup>7</sup> )
Minimum radius of curvature, longitudinal and transverse,		
at reference temperature for strain gauges with leads		
for SG with integrated solder tabs		
within measuring grid area	mm (inch)	0.3 (0.012)
within solder tabs area	mm (inch)	0.3 (0.012)
Bonding material than can be used	mm (inch)	2 (0.079)
Cold-curing adhesives		Z 70; X 60; X 280
Hot-curing adhesives		EP 150; EP 310S

<sup>(1)</sup> The data depend on the various parameters of the specific application and are therefore stated for representative examples only.

<sup>(2)</sup> With measuring grid lengths of 0.3 mm (0.012 inch) and 0.6 mm (0.024 inch), the nominal resistance may deviate by ± 1%. For the types LY 51/ LY5x the deviation is ± 0.75%. For XY9x, RY9x and the KY types (per chain) it is ± 0.5%.

<sup>(3)</sup> Matching to plastic (code number 8) is only possible in the temperature range of -10°C ... +50°C (14°F ... +122°F).

# Series Y

with 1 measuring grid / linear SG

## LY11

Linear SG  
Temperature response matched to steel  
with  $\alpha = 10,8 \cdot 10^{-6}/K$  ( $6,0 \cdot 10^{-6}/^{\circ}F$ )

## LY13

Temperature response matched to aluminum  
with  $\alpha = 23 \cdot 10^{-6}/K$  ( $12,8 \cdot 10^{-6}/^{\circ}F$ )

## LY1x

Temperature response matched to customer's choice  
see page 16

Illustrations show actual size  
(Data: grid length in mm/inch)

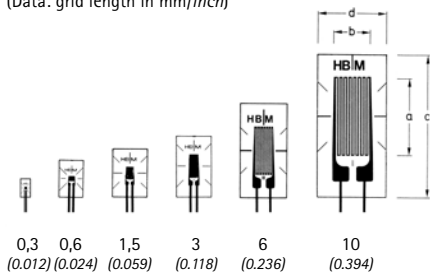

Contents per package: 10 pcs.

Types available ex stock		Variants	No-minal resistance	Dimensions (mm/inch)				Max. perm. effective bridge ex. voltage	Solder terminals
Steel	Aluminum			Other	Measuring grid		Measuring grid carrier		
			$\Omega$	a	b	c	d	V	
1-LY11-0.3/120		1-LY1x-0.3/120 <sup>(*)</sup>	120	0.3 0.012	0.9 0.035	2 0.079	1.2 0.047	0.6	LS 7
1-LY11-0.6/120	1-LY13-0.6/120	1-LY1x-0.6/120 <sup>(*)</sup>	120	0.6 0.024	1 0.039	5 0.197	3.2 0.126	1.5	LS 7
1-LY11-1.5/120	1-LY13-1.5/120	1-LY1x-1.5/120	120	1.5 0.059	1.2 0.047	6.5 0.256	4.7 0.185	2.5	LS 7
1-LY11-3/120	1-LY13-3/120	1-LY1x-3/120	120	3 0.118	1.6 0.063	8.5 0.335	4.5 0.177	4	LS 7
1-LY11-3/120A		1-LY1x-3/120A	120	3 0.118	1.6 0.063	8.5 0.335	4.5 0.177	4	LS 7
1-LY11-6/120	1-LY13-6/120	1-LY1x-6/120	120	6 0.236	2.7 0.106	13 0.512	6 0.236	8	LS 5
1-LY11-6/120A		1-LY1x-6/120A	120	6 0.236	2.7 0.106	13 0.512	6 0.236	8	LS 5
1-LY11-10/120	1-LY13-10/120	1-LY1x-10/120	120	10 0.394	4.6 0.181	18.5 0.728	9.5 0.374	13	LS 5
1-LY11-10/120A		1-LY1x-10/120A	120	10 0.394	4.6 0.181	18.5 0.728	9.5 0.374	13	LS 5
1-LY11-1.5/350	1-LY13-1.5/350	1-LY1x-1.5/350 <sup>(*)</sup>	350	1.5 0.059	1.2 0.047	5.7 0.224	4.7 0.185	4.5	LS 7
1-LY11-3/350	1-LY13-3/350	1-LY1x-3/350	350	3 0.118	1.6 0.063	8.5 0.335	4.5 0.177	7	LS 7
		1-LY1x-3/350A	350	3 0.118	1.6 0.063	8.5 0.335	4.5 0.177	7	LS 7
1-LY11-6/350	1-LY13-6/350	1-LY1x-6/350	350	6 0.236	2.8 0.11	13 0.512	6 0.236	13	LS 5
		1-LY1x-6/350A	350	6 0.236	2.8 0.11	13 0.512	6 0.236	13	LS 5
1-LY11-10/350		1-LY1x-10/350	350	10 0.394	5.0 0.197	18.5 0.728	9.5 0.374	23	LS 5
		1-LY1x-10/350A	350	10 0.394	5.0 0.197	18.5 0.728	9.5 0.374	23	LS 5

## LY21

Linear SG  
Temperature response matched to steel  
with  $\alpha = 10,8 \cdot 10^{-6}/K$  ( $6,0 \cdot 10^{-6}/^{\circ}F$ )

## LY2x

Temperature response matched to customer's choice  
see page 16

Illustrations show actual size  
(Data: grid length in mm/inch)

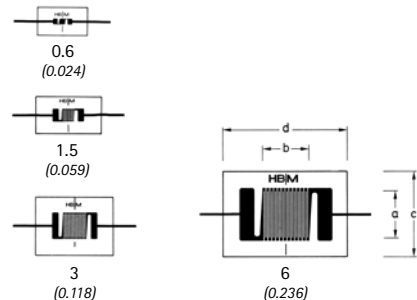

Contents per package: 10 pcs.

Types available ex stock		Variants	No-minal resistance	Dimensions (mm/inch)				Max. perm. effective bridge ex. voltage	Solder terminals
Steel	Aluminum			Other	Measuring grid		Measuring grid carrier		
			$\Omega$	a	b	c	d	V	
1-LY21-0.6/120		1-LY2x-0.6/120 <sup>(*)</sup>	120	0.6 0.024	0.6 0.024	3.5 0.138	6.4 0.252	1	LS 7
		1-LY2x-1.5/120	120	1.5 0.059	1.5 0.059	4.7 0.185	8.3 0.327	2	LS 5
1-LY21-3/120		1-LY2x-3/120	120	3 0.118	2.8 0.11	7.5 0.295	10 0.394	6	LS 5
		1-LY2x-6/120	120	6 0.236	6 0.236	11 0.433	16 0.63	12	LS 4

<sup>(\*)</sup> Types are only available with matching to aluminum, ferritic or austenitic steel

# Series Y

with 1 measuring grid / linear SG

## LY41

Linear SG  
Temperature response matched to steel  
with  $\alpha = 10,8 \cdot 10^{-6}/K$  ( $6,0 \cdot 10^{-6}/^{\circ}F$ )

## LY43

Temperature response matched to aluminum  
with  $\alpha = 23 \cdot 10^{-6}/K$  ( $12,8 \cdot 10^{-6}/^{\circ}F$ )

## LY4x

Temperature response matched to customer's choice  
see page 16

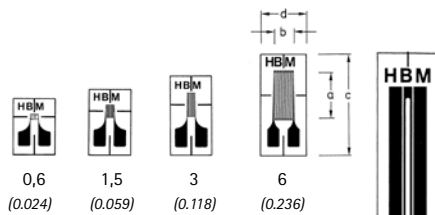

Illustrations show actual size  
(Data: grid length in mm/inch)

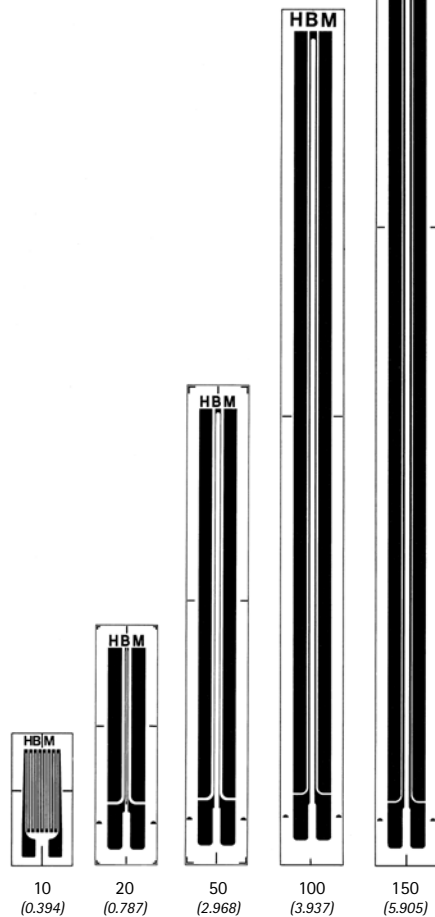

Contents per package: 10 pcs.

Types available ex stock		Variants	No- nominal resistance  $\Omega$	Dimensions (mm/inch)				Max. perm. effective bridge ex. voltage  V	Solder terminals (1)
Steel	Aluminum	Other		Measuring grid		Measuring grid carrier			
			a	b	c	d			
1-LY41-0.6/120		1-LY4x-0.6/120 <sup>(#)</sup>	120	0.6 0.024	1.1 0.043	6 0.236	4 0.157	1.5	LS 5
1-LY41-1.5/120		1-LY4x-1.5/120	120	1.5 0.059	1.2 0.047	7 0.276	5 0.197	2.5	LS 5
1-LY41-3/120	1-LY43-3/120	1-LY4x-3/120	120	3 0.118	1.2 0.047	8 0.315	5 0.197	3.5	LS 5
		1-LY4x-3/120A	120	3 0.118	1.2 0.047	8 0.315	5 0.197	3.5	LS 5
1-LY41-6/120	1-LY43-6/120	1-LY4x-6/120	120	6 0.236	2.7 0.106	13.9 0.547	5.9 0.232	8	LS 5
1-LY41-6/120A		1-LY4x-6/120A	120	6 0.236	2.7 0.106	13.9 0.547	5.9 0.232	8	LS 5
1-LY41-10/120		1-LY4x-10/120	120	10 0.394	4.9 0.193	18 0.709	8 0.315	14	LS 5
		1-LY4x-10/120A	120	10 0.394	4.9 0.193	18 0.709	8 0.315	14	LS 5
1-LY41-20/120		1-LY4x-20/120	120	20 0.787	0.5 0.020	31.8 1.252	8.2 0.323	6.5	LS 5
1-LY41-50/120		1-LY4x-50/120	120	50 1.969	0.8 0.031	63.6 2.504	8.2 0.323	12	LS 5
1-LY41-100/120		1-LY4x-100/120	120	100 3.937	1 0.039	114.8 4.520	8.2 0.323	19	LS 5
1-LY41-150/120		1-LY4x-150/120	120	150 5.906	1.2 0.047	165.6 6.520	8.2 0.323	25	LS 5
1-LY41-1.5/350		1-LY4x-1.5/350 <sup>(#)</sup>	350	1.5 0.059	2.3 0.091	9.2 0.362	5.9 0.232	6.5	LS 5
1-LY41-3/350	1-LY43-3/350	1-LY4x-3/350	350	3 0.118	2.5 0.098	10.9 0.429	5.9 0.232	9	LS 5
1-LY41-3/350A		1-LY4x-3/350A	350	3 0.118	2.5 0.098	10.9 0.429	5.9 0.232	9	LS 5
1-LY41-6/350	1-LY43-6/350	1-LY4x-6/350 <sup>(2)</sup>	350	6 0.236	2.8 0.110	13.9 0.547	5.9 0.232	15	LS 5
		1-LY4x-6/350A	350	6 0.236	2.8 0.110	13.9 0.547	5.9 0.232	15	LS 5
1-LY41-10/350		1-LY4x-10/350	350	10 0.394	5 0.197	18 0.709	8 0.315	24	LS 5
		1-LY4x-10/350A	350	10 0.394	5 0.197	18 0.709	8 0.315	24	LS 5
1-LY41-3/700	1-LY43-3/700	1-LY4x-3/700	700	3 0.118	2.7 0.106	10.9 0.429	5.9 0.232	13	LS 5
1-LY41-6/700		1-LY4x-6/700	700	6 0.236	4.1 0.161	13.9 0.547	5.9 0.232	23	LS 5
		1-LY4x-10/700	700	10 0.394	5 0.197	18 0.709	8 0.315	33	LS 5
		1-LY4x-3/1000 <sup>(#)</sup>	1,000	3 0.118	2.7 0.106	10.9 0.429	5.9 0.232	16	LS 5
1-LY41-6/1000		1-LY4x-6/1000	1,000	6 0.236	4.2 0.165	13.9 0.547	5.9 0.232	27	LS 5
		1-LY4x-10/1000	1,000	10 0.394	5 0.197	18 0.709	8 0.315	40	LS 5

(1) Solder terminals are not compulsory

(2) With the temperature adaptation for quartz glass / composite (x=6) available ex stock (preferential gage)

(#) Types are only available with matching to aluminum, ferritic or austenitic steel

# Series Y

with 1 measuring grid / linear SG

## LY5x

Temperature response matched to customer's choice see page 16

Illustrations show actual size (Data: grid length in mm/inch)

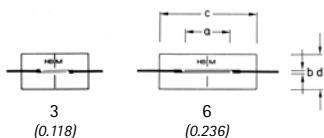

Contents per package: 10 pcs.

Variants	No-minal resistance	Dimensions (mm/inch)				Max. perm. effective bridge ex. voltage	Solder terminals
		Measuring grid		Measuring grid carrier			
Other	Ω	a	b	c	d	V	
1-LY5x-3/120	120	3 0.118	0.4 0.016	9 0.354	4.7 0.185	2	LS 7
1-LY5x-6/120	120	6 0.236	0.4 0.016	13 0.512	4.7 0.185	3	LS 7

## LY61

Linear SG  
Temperature response matched to steel with  $\alpha = 10,8 \cdot 10^{-6}/K$  ( $6,0 \cdot 10^{-6}/^{\circ}F$ )

## LY63

Temperature response matched to aluminum with  $\alpha = 23 \cdot 10^{-6}/K$  ( $12,8 \cdot 10^{-6}/^{\circ}F$ )

## LY6x

Temperature response matched to customer's choice see page 16

Illustrations show actual size (Data: grid length in mm/inch)

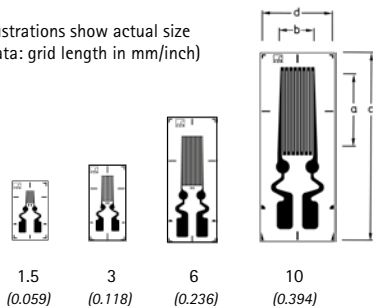

Contents per package: 10 pcs.

Types available ex stock		Variants	No-minal resistance	Dimensions (mm/inch)				Max. perm. effective bridge ex. voltage	Solder terminals
Steel	Aluminum			Measuring grid		Measuring grid carrier			
		Other	Ω	a	b	c	d	V	
		1-LY6x-1.5/120	120	1.5 0.059	1.0 0.039	7.8 0.307	4.7 0.185	2.5	-
		1-LY61-3/120	120	3 0.118	1.5 0.059	9.8 0.386	4.7 0.185	4	-
		1-LY6x-3/120A	120	3 0.118	1.5 0.059	9.8 0.386	4.7 0.185	4	-
	1-LY63-6/120	1-LY6x-6/120	120	6 0.236	2.7 0.106	16 0.63	6.3 0.248	8	-
		1-LY6x-6/120A	120	6 0.236	2.7 0.106	16 0.63	6.3 0.248	8	-
		1-LY61-10/120	120	10 0.394	4.6 0.181	23.5 0.925	9.3 0.366	13	-
		1-LY61-3/350	350	3 0.118	1.6 0.063	9.8 0.386	4.7 0.185	7	-
		1-LY6x-3/350A	350	3 0.118	1.6 0.063	9.8 0.386	4.7 0.185	7	-
	1-LY63-6/350	1-LY6x-6/350 <sup>(1)</sup>	350	6 0.236	2.7 0.106	16 0.63	6.3 0.248	13	-
		1-LY61-6/350A	350	6 0.236	2.7 0.106	16 0.63	6.3 0.248	13	-
		1-LY61-10/350	350	10 0.394	5 0.197	23.5 0.925	9.3 0.366	21	-

<sup>(1)</sup> With the temperature adaptation for quartz glass / composite (x=6) available ex stock (preferential gage)

<sup>(#)</sup> Types are only available with matching to aluminum, ferritic or austenitic steel

# Series Y

with 1 measuring grid / linear SG

## LY71

Linear SG  
Temperature response matched to steel  
with  $\alpha = 10,8 \cdot 10^{-6}/K$  ( $6,0 \cdot 10^{-6}/^{\circ}F$ )

## LY73

Temperature response matched to aluminum  
with  $\alpha = 23 \cdot 10^{-6}/K$  ( $12,8 \cdot 10^{-6}/^{\circ}F$ )

## LY7x

Temperature response matched to customer's choice  
see page 16

Illustrations show actual size  
(Data: grid length in mm/inch)

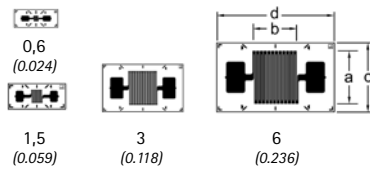

Contents per package: 10 pcs.

Types available ex stock		Variants	Nominal resistance $\Omega$	Dimensions (mm/inch)				Max. perm. effective bridge ex. voltage V	Solder terminals <sup>(1)</sup>
Steel	Aluminum	Other		Measuring grid		Measuring grid carrier			
				a	b	c	d		
		1-LY7x-0.6/120 <sup>(#)</sup>	120	0,6 0,024	1 0,039	2,3 0,091	5,6 0,22	1	LS7
		1-LY71-1.5/120	120	1,5 0,059	1,5 0,059	3,4 0,134	7,5 0,295	2,5	LS5
		1-LY71-3/120	120	3 0,118	3 0,11	5,5 0,217	10,5 0,413	5	LS4
		1-LY7x-6/120	120	6 0,236	6 0,236	9 0,354	15,5 0,61	10	LS4
	1-LY73-1.5/350	1-LY7x-1.5/350 <sup>(#)</sup>	350	1,5 0,059	1,6 0,063	3,4 0,134	7,5 0,295	5	LS5
		1-LY71-3/350	350	3 0,118	2,7 0,106	5,5 0,217	10,5 0,413	8,5	LS4
		1-LY7x-6/350	350	6 0,236	5,6 0,22	9 0,354	15,5 0,61	18	LS4

## LY81

Linear SG  
Temperature response matched to steel  
with  $\alpha = 10,8 \cdot 10^{-6}/K$  ( $6,0 \cdot 10^{-6}/^{\circ}F$ )

## LY83

Temperature response matched to aluminum  
with  $\alpha = 23 \cdot 10^{-6}/K$  ( $12,8 \cdot 10^{-6}/^{\circ}F$ )

## LY8x

Temperature response matched to customer's choice  
see page 16

Illustrations show actual size  
(Data: grid length in mm/inch)

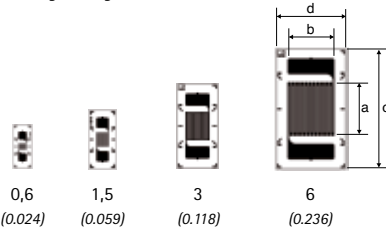

Contents per package: 10 pcs.

Types available ex stock		Variants	Nominal resistance $\Omega$	Dimensions (mm/inch)				Max. perm. effective bridge ex. voltage V	Solder terminals <sup>(1)</sup>
Steel	Aluminum	Other		Measuring grid		Measuring grid carrier			
				a	b	c	d		
		1-LY8x-0.6/120 <sup>(#)</sup>	120	0,6 0,024	1 0,039	5,6 0,22	2,3 0,091	1	LS7
		1-LY81-1.5/120	120	1,5 0,059	1,5 0,059	7,5 0,295	3,4 0,134	2,5	LS5
		1-LY81-3/120	120	3 0,118	3 0,118	10,5 0,413	5,5 0,217	5	LS4
		1-LY8x-6/120	120	6 0,236	6 0,236	15,5 0,61	9 0,354	10	LS4
		1-LY81-1.5/350	350	1,5 0,059	1,5 0,059	7,5 0,295	3,4 0,134	5	LS5
		1-LY8x-3/350	350	3 0,118	3 0,118	10,5 0,413	5,5 0,217	8,5	LS4
		1-LY8x-6/350	350	6 0,236	5,6 0,22	15,5 0,61	9 0,354	18	LS4

<sup>(1)</sup> Solder terminals are not compulsory

<sup>(#)</sup> Types are only available with matching to aluminum, ferritic or austenitic steel

# Series Y

with 2 measuring grids / double SG

## DY11

Double SG  
Temperature response matched to steel  
with  $\alpha = 10.8 \cdot 10^{-6}/K$  ( $6.0 \cdot 10^{-6}/^{\circ}F$ )

## DY13

Temperature response matched to aluminum  
with  $\alpha = 23 \cdot 10^{-6}/K$  ( $12.8 \cdot 10^{-6}/^{\circ}F$ )

## DY1x

Temperature response matched to customer's choice  
see page 16

Illustrations show actual size  
(Data: grid length in mm/inch)

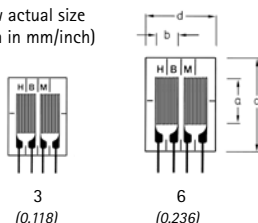

Contents per package: 5 pcs.

Types available ex stock		Variants	No-minal resistance	Dimensions (mm/inch)				Max. perm. effective bridge ex. voltage	Solder terminals
Steel	Aluminum			Measuring grid		Measuring grid carrier			
		Other	$\Omega$	a	b	c	d	V	
1-DY11-3/350	1-DY13-3/350	1-DY1x-3/350	350	3 0.118	2.7 0.106	9 0.354	8 0.315	9	LS 7
1-DY11-6/350	1-DY13-6/350	1-DY1x-6/350	350	6 0.236	3.2 0.126	12.5 0.492	9.4 0.370	14	LS 7

## DY41

Double SG  
Temperature response matched to steel  
with  $\alpha = 10.8 \cdot 10^{-6}/K$  ( $6.0 \cdot 10^{-6}/^{\circ}F$ )

## DY43

Temperature response matched to aluminum  
with  $\alpha = 23 \cdot 10^{-6}/K$  ( $12.8 \cdot 10^{-6}/^{\circ}F$ )

## DY4x

Temperature response matched to customer's choice  
see page 16

Illustrations show actual size  
(Data: grid length in mm/inch)

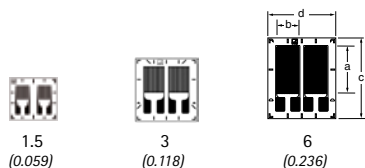

Contents per package: 5 pcs.

Types available ex stock		Variants	No-minal resistance	Dimensions (mm/inch)				Max. perm. effective bridge ex. voltage	Solder terminals <sup>(1)</sup>
Steel	Aluminum			Measuring grid		Measuring grid carrier			
		Other	$\Omega$	a	b	c	d	V	
1-DY41-1.5/350		1-DY4x-1.5/350 <sup>(#)</sup>	350	1.5 0.059	1.8 0.071	5.5 0.217	6 0.236	5	LS 7
1-DY41-3/350	1-DY43-3/350	1-DY4x-3/350	350	3 0.118	2.7 0.106	8.2 0.323	8 0.315	8.5	LS 7
1-DY41-6/350		1-DY4x-6/350	350	6 0.236	3.2 0.126	10.7 0.421	9 0.354	13	LS 7

<sup>(1)</sup> Solder terminals are not compulsory

<sup>(#)</sup> Types are only available with matching to aluminum, ferritic or austenitic steel



# Series Y

with 2 measuring grids / T rosette

## XY11

0°/90° T rosette  
Temperature response matched to steel  
with  $\alpha = 10,8 \cdot 10^{-6}/K$  ( $6,0 \cdot 10^{-6}/^{\circ}F$ )

## XY13

Temperature response matched to aluminum  
with  $\alpha = 23 \cdot 10^{-6}/K$  ( $12,8 \cdot 10^{-6}/^{\circ}F$ )

## XY1x

Temperature response matched to customer's choice  
see page 16

Illustrations show actual size  
(Data: grid length in mm/inch)

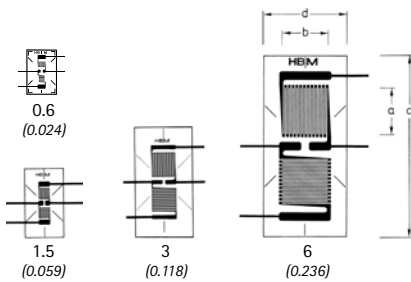

Contents per package: 5 pcs.

Types available ex stock		Variants	No-minal resistance	Dimensions (mm/inch)				Max. perm. effective bridge ex. voltage	Solder terminals
Steel	Aluminum	Other		Measuring grid		Measuring grid carrier			
			$\Omega$	a	b	c	d	V	
1-XY11-0.6/120		1-XY1x-0.6/120 <sup>(#)</sup>	120	0.6 0.024	1.1 0.043	6 0.236	4 0.157	1.5	LS 7
1-XY11-1.5/120	1-XY13-1.5/120	1-XY1x-1.5/120	120	1.5 0.059	1.5 0.059	9 0.354	5 0.197	3	LS 5
1-XY11-3/120	1-XY13-3/120	1-XY1x-3/120	120	3 0.118	3.2 0.126	14.5 0.571	7.5 0.295	6	LS 4
1-XY11-6/120		1-XY1x-6/120	120	6 0.236	6.5 0.256	23.5 0.925	11 0.433	12	LS 5
1-XY11-1.5/350		1-XY1x-1.5/350 <sup>(#)</sup>	350	1.5 0.059	1.5 0.059	9 0.354	5 0.197	5	LS 5
1-XY11-3/350	1-XY13-3/350	1-XY1x-3/350	350	3 0.118	3.1 0.122	14.4 0.567	7.3 0.287	10	LS 4
1-XY11-6/350		1-XY1x-6/350	350	6 0.236	6.3 0.248	23.3 0.917	10.5 0.413	20	LS 4

## XY31

0°/90° T rosette  
Temperature response matched to steel  
with  $\alpha = 10,8 \cdot 10^{-6}/K$  ( $6,0 \cdot 10^{-6}/^{\circ}F$ )

## XY33

Temperature response matched to aluminum  
with  $\alpha = 23 \cdot 10^{-6}/K$  ( $12,8 \cdot 10^{-6}/^{\circ}F$ )

## XY3x

Temperature response matched to customer's choice  
see page 16

Illustrations show actual size  
(Data: grid length in mm/inch)

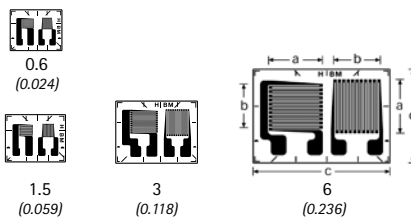

Contents per package: 5 pcs.

Types available ex stock		Variants	No-minal resistance	Dimensions (mm/inch)				Max. perm. effective bridge ex. voltage	Solder terminals <sup>(1)</sup>
Steel	Aluminum	Other		Measuring grid		Measuring grid carrier			
			$\Omega$	a	b	c	d	V	
1-XY31-0.6/120		1-XY3x-0.6/120 <sup>(#)</sup>	120	0.6 0.024	1 0.039	7 0.276	6 0.236	1.5	LS7
1-XY31-1.5/120	1-XY33-1.5/120	1-XY3x-1.5/120	120	1.5 0.059	1.6 0.063	8 0.315	6.3 0.248	3	LS7
1-XY31-3/120		1-XY3x-3/120	120	3 0.118	3.2 0.126	10.5 0.413	8 0.315	5.5	LS7
1-XY31-6/120		1-XY3x-6/120	120	6 0.236	6.3 0.248	17.5 0.689	12 0.472	11	LS4
1-XY31-1.5/350	1-XY33-1.5/350	1-XY3x-1.5/350 <sup>(#)</sup>	350	1.5 0.059	1.7 0.067	7.7 0.303	6.3 0.248	5	LS7
1-XY31-3/350	1-XY33-3/350	1-XY3x-3/350	350	3 0.118	3.3 0.13	10.9 0.429	7.6 0.299	10	LS5
1-XY31-6/350	1-XY33-6/350	1-XY3x-6/350	350	6 0.236	6.5 0.256	18 0.709	12 0.472	20	LS4

<sup>(1)</sup> Solder terminals are not compulsory

<sup>(2)</sup> With the temperature adaptation for quartz glass / composite (x=6) available ex stock (preferential gage)

<sup>(#)</sup> Types are only available with matching to aluminum, ferritic or austenitic steel

# Series Y

with 2 measuring grids / T rosette

## XY71

0°/90° T rosette  
Temperature response matched to steel  
with  $\alpha = 10,8 \cdot 10^{-6}/K$  ( $6,0 \cdot 10^{-6}/^{\circ}F$ )

## XY73

Temperature response matched to aluminum  
with  $\alpha = 23 \cdot 10^{-6}/K$  ( $12,8 \cdot 10^{-6}/^{\circ}F$ )

## XY7x

Temperature response matched to customer's choice  
see page 16

Illustrations show actual size  
(Data: grid length in mm/inch)



0.6  
(0.024)



1.5  
(0.059)



3  
(0.118)

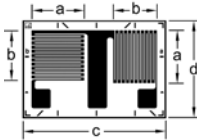

6  
(0.236)

Contents per package: 5 pcs.

Types available ex stock		Variants	No- minal resistance	Dimensions (mm/inch)				Max. perm. effective bridge ex. voltage	Solder terminals (1)
Steel	Aluminum	Other		Measuring grid		Measuring grid carrier			
			$\Omega$	a	b	c	d	V	
		1-XY7x-0.6/120 <sup>(*)</sup>	120	0.6 0.024	0.8 0.031	5.7 0.224	4.3 0.169	1	LS7
		1-XY7x-1.5/120	120	1.5 0.059	1.4 0.055	6.5 0.256	5.3 0.209	2.5	LS7
		1-XY7x-3/120	120	3 0.118	3 0.118	9.9 0.390	7.3 0.287	5.5	LS7
		1-XY7x-6/120	120	6 0.236	5.7 0.224	16.2 0.638	11 0.433	11	LS4
1-XY71-1.5/350	1-XY73-1.5/350	1-XY7x-1.5/350 <sup>(*)</sup>	350	1.5 0.059	1.4 0.059	6.5 0.256	5.3 0.209	4.5	LS7
1-XY71-3/350	1-XY73-3/350	1-XY7x-3/350	350	3 0.118	3 0.118	9.9 0.390	7.3 0.287	9.5	LS5
		1-XY7x-6/350	350	6 0.236	5.7 0.224	16.2 0.638	11 0.433	18.5	LS4

## XY91

0°/90° stacked T rosette  
Temperature response matched to steel  
with  $\alpha = 10,8 \cdot 10^{-6}/K$  ( $6,0 \cdot 10^{-6}/^{\circ}F$ )

## XY93

Temperature response matched to aluminum  
with  $\alpha = 23 \cdot 10^{-6}/K$  ( $12,8 \cdot 10^{-6}/^{\circ}F$ )

## XY9x

Temperature response matched to customer's choice  
see page 16

Illustrations show actual size  
(Data: grid length in mm/inch)



1,5



3

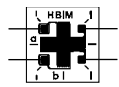

6

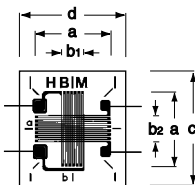

10

Contents per package: 5 pcs.

Types available ex stock		Variants	No- minal resistance	Dimensions (mm/inch)					Max. perm. effective bridge ex. voltage	Solder terminals
Steel	Aluminum	Other		Measuring grid			Measuring grid carrier			
			$\Omega$	a	b1	b2	c	d	V	
1-XY91-1.5/120	1-XY93-1.5/120	1-XY9x-1.5/120	120	1.5 0.059	1.2 0.047	1.2 0.047	4.7 0.185	6.7 0.264	1	LS 5
1-XY91-3/120	1-XY93-3/120	1-XY9x-3/120	120	3 0.118	1.4 0.055	1.3 0.051	6.2 0.244	7.9 0.311	2	LS 5
1-XY91-6/120	1-XY93-6/120	1-XY9x-6/120	120	6 0.236	1.9 0.075	2.2 0.087	10 0.394	9.6 0.378	3.5	LS 4
1-XY91-10/120		1-XY9x-10/120	120	10 0.394	3.2 0.126	3.8 0.15	15.2 0.598	14.0 0.551	6.5	LS 212
1-XY91-1.5/350		1-XY9x-1.5/350 <sup>(*)</sup>	350	1.5 0.059	1.5 0.059	1.5 0.059	4.7 0.185	6.7 0.264	2.5	LS 5
1-XY91-3/350	1-XY93-3/350	1-XY9x-3/350	350	3 0.118	1.5 0.059	1.4 0.055	6.2 0.244	7.9 0.311	3.5	LS 5
1-XY91-6/350	1-XY93-6/350	1-XY9x-6/350	350	6 0.236	2 0.079	2.2 0.087	10 0.394	9.6 0.378	6	LS 4
		1-XY9x-10/350	350	10 0.394	3.3 0.13	3.7 0.146	15.2 0.551	14 0.551	11.5	LS 212

(1) Solder terminals are not compulsory

(\*) Types are only available with matching to aluminum, ferritic or austenitic steel

# Series Y

with 2 measuring grids / Shear/torsion SG / T rosette

## XY101

0°/90° T rosette  
Temperature response matched to steel  
with  $\alpha = 10,8 \cdot 10^{-6}/K$  ( $6,0 \cdot 10^{-6}/^{\circ}F$ )

## XY103

Temperature response matched to aluminum  
with  $\alpha = 23 \cdot 10^{-6}/K$  ( $12,8 \cdot 10^{-6}/^{\circ}F$ )

## XY10x

Temperature response matched to customer's choice  
see page 16

Illustrations show actual size  
(Data: grid length in mm/inch)

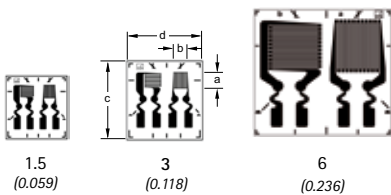

Contents per package: 5 pcs.

Types available ex stock		Variants	No- nominal resistance	Dimensions (mm/inch)				Max. perm. effective bridge ex. voltage	Solder terminals (1)
Steel	Aluminum			Measuring grid		Measuring grid carrier			
		Other	$\Omega$	a	b	c	d	V	
		1-XY10x-1.5/120	120	1.5 0.059	1.6 0.063	8 0.315	8.3 0.327	1.5	LS7
1-XY101-3/120		1-XY10x-3/120	120	3 0.118	3.2 0.126	10.6 0.417	9.8 0.386	3	LS5
		1-XY10x-6/120	120	6 0.236	6.5 0.256	18 0.709	16.5 0.65	5.5	LS4
1-XY101-3/350	1-XY103-3/350	1-XY10x-3/350	350	3 0.118	3.3 0.13	10.6 0.417	9.8 0.386	11	LS5
		1-XY10x-6/350	350	6 0.236	6 0.236	18 0.709	16.5 0.65	10	LS4

## XY21

Shear/torsion half bridge  
Temperature response matched to steel  
with  $\alpha = 10,8 \cdot 10^{-6}/K$  ( $6,0 \cdot 10^{-6}/^{\circ}F$ )

## XY23

Temperature response matched to aluminum  
with  $\alpha = 23 \cdot 10^{-6}/K$  ( $12,8 \cdot 10^{-6}/^{\circ}F$ )

## XY2x

Temperature response matched to customer's choice  
see page 16

Illustrations show actual size  
(Data: grid length in mm/inch)

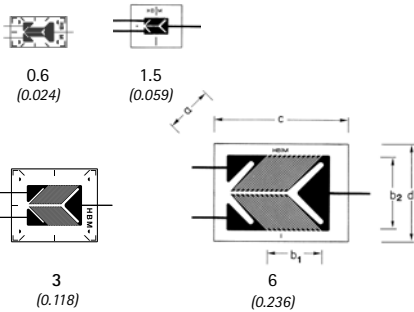

Contents per package: 5 pcs.

Types available ex stock		Variants	No- nominal resistance	Dimensions (mm/inch)					Max. perm. effective bridge ex. voltage	Solder terminals
Steel	Aluminum			Measuring grid			Measuring grid carrier			
		Other	$\Omega$	a	b1	b2	c	d	V	
		1-XY2x-0.6/120 <sup>(*)</sup>	120	0.6 0.024	2.2 0.087	1.1 0.043	7.5 0.295	4 0.157	2.5	LS 7
1-XY21-1.5/120		1-XY2x-1.5/120	120	1.5 0.059	1.7 0.067	2.5 0.098	6.8 0.268	4.5 0.177	4.5	LS 7
1-XY21-3/120		1-XY2x-3/120	120	3 0.118	3.7 0.146	5.3 0.209	11.2 0.441	9.5 0.374	6	LS 5
1-XY21-6/120		1-XY2x-6/120	120	6 0.236	8 0.315	10 0.394	17.5 0.689	12.7 0.5	11	LS 4
1-XY21-1.5/350		1-XY2x-1.5/350 <sup>(*)</sup>	350	1.5 0.059	2.2 0.087	2.5 0.098	7.4 0.291	4.5 0.177	5	LS 7
1-XY21-3/350		1-XY2x-3/350	350	3 0.118	4.2 0.165	5.3 0.209	11.2 0.441	9.5 0.374	10	LS 4
1-XY21-6/350		1-XY2x-6/350	350	6 0.236	8 0.315	10 0.394	17.5 0.689	12.7 0.5	19	LS 4
		1-XY2x-3/700 <sup>(*)</sup>	700	3 0.118	4.0 0.157	4.7 0.185	11.2 0.441	9.5 0.374	14	LS 5
		1-XY2x-6/700	700	6 0.236	7.8 0.307	9.2 0.362	17.5 0.689	12.7 0.5	27	LS 4

(1) Solder terminals are not compulsory

(\*) Types are only available with matching to aluminum, ferritic or austenitic steel

# Series Y

with 2 measuring grids / Torsion/shear SG

## XY41

Shear/torsion half bridge  
Temperature response matched to steel  
with  $\alpha = 10,8 \cdot 10^{-6}/K$  ( $6.0 \cdot 10^{-6}/^{\circ}F$ )

## XY43

Temperature response matched to aluminum  
with  $\alpha = 23 \cdot 10^{-6}/K$  ( $12.8 \cdot 10^{-6}/^{\circ}F$ )

## XY4x

Temperature response matched to customer's choice  
see page 16

Illustrations show actual size  
(Data: grid length in mm/inch)



0.6  
(0.024)



1.5  
(0.059)



3  
(0.118)

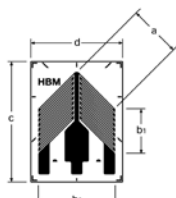

6  
(0.236)

Types available ex stock		Variants	No- minal resis- tance	Dimensions (mm/inch)					Max. perm. effective bridge ex. voltage	Solder terminals (1)
Steel	Aluminum	Other		Measuring grid			Measuring grid carrier			
			$\Omega$	a	b1	b2	c	d	V	
1-XY41-0.6/120		1-XY4x-0.6/120 <sup>(#)</sup>	120	0.6 0.024	2.2 0.087	1.6 0.063	6.5 0.256	4.6 0.181	1.5	LS 7
1-XY41-1.5/120		1-XY4x-1.5/120	120	1.5 0.059	1.8 0.071	3.1 0.122	7.5 0.295	4.6 0.181	2.5	LS 7
1-XY41-3/120		1-XY4x-3/120	120	3 0.118	3 0.118	5.4 0.213	11 0.433	8 0.315	5	LS 7
1-XY41-6/120		1-XY4x-6/120	120	6 0.236	6 0.236	10.2 0.402	16 0.63	12.2 0.48	9.5	LS 4
1-XY41-1.5/350		1-XY4x-1.5/350 <sup>(#)</sup>	350	1.5 0.059	2.1 0.083	3.1 0.122	7.5 0.295	4.5 0.177	4	LS 7
1-XY41-3/350	1-XY43-3/350	1-XY4x-3/350	350	3 0.118	4.2 0.165	5.6 0.22	11 0.433	8 0.315	9.5	LS 7
1-XY41-6/350		1-XY4x-6/350	350	6 0.236	6 0.236	10 0.394	16 0.63	12.2 0.48	16	LS 4
1-XY41-3/700		1-XY4x-3/700	700	3 0.118	4.2 0.165	5.6 0.22	11 0.433	8 0.315	13.5	LS 7
		1-XY4x-6/700	700	6 0.236	6.1 0.24	9.9 0.39	16 0.63	12.2 0.48	23	LS 4

(1) Solder terminals are not compulsory

(#) Types are only available with matching to aluminum, ferritic or austenitic steel

Contents per package: 5 pcs.

# Series Y

with 3 measuring grids / rosettes

## RY11

0°/45°/90° rosette  
Temperature response matched to steel  
with  $\alpha = 10,8 \cdot 10^{-6}/K$  ( $6,0 \cdot 10^{-6}/^{\circ}F$ )

## RY13

Temperature response matched to aluminum  
with  $\alpha = 23 \cdot 10^{-6}/K$  ( $12,8 \cdot 10^{-6}/^{\circ}F$ )

## RY1x

Temperature response matched to customer's choice  
see page 16

Illustrations show actual size  
(Data: Dimension a2 in mm/inch)

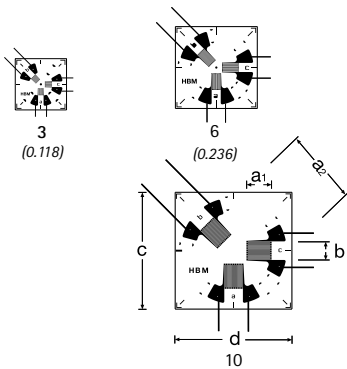

Contents per package: 5 pcs.

## RY31

0°/45°/90° rosette  
Temperature response matched to steel  
with  $\alpha = 10,8 \cdot 10^{-6}/K$  ( $6,0 \cdot 10^{-6}/^{\circ}F$ )

## RY33

Temperature response matched to aluminum  
with  $\alpha = 23 \cdot 10^{-6}/K$  ( $12,8 \cdot 10^{-6}/^{\circ}F$ )

## RY3x

Temperature response matched to customer's choice  
see page 16

Illustrations show actual size  
(Data: Dimension a2 in mm/inch)

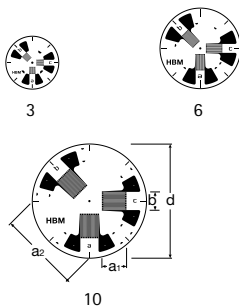

Contents per package: 5 pcs.

Types available ex stock		Variants	No-nominal resistance	Dimensions (mm/inch)					Max. perm. effective bridge ex. voltage	Solder terminals
Steel	Aluminum	Other		Measuring grid			Measuring grid carrier			
			$\Omega$	a1	a2	b	c	d	V	
1-RY11-3/120		1-RY1x-3/120 <sup>(#)</sup>	120	0.8 0.031	3 0.118	0.8 0.031	7 0.276	7 0.276	1.5	LS 7
1-RY11-6/120	1-RY13-6/120	1-RY1x-6/120	120	2 0.079	6 0.236	1.4 0.055	11 0.433	11 0.433	3	LS 5
1-RY11-10/120		1-RY1x-10/120	120	2.9 0.114	10 0.394	2.7 0.106	15.4 0.606	15.4 0.606	5	LS 4

Types available ex stock		Variants	No-nominal resistance	Dimensions (mm/inch)				Max. perm. effective bridge ex. voltage	Solder terminals <sup>(1)</sup>
Steel	Aluminum	Other		Measuring grid			Measuring grid carrier		
			$\Omega$	a1	a2	b	d	V	
1-RY31-3/120		1-RY3x-3/120 <sup>(#)</sup>	120	0.8 0.031	3 0.118	0.8 0.031	6.9 0.272	1.5	LS 7
1-RY31-6/120	1-RY33-6/120	1-RY3x-6/120	120	2 0.079	6 0.236	1.4 0.055	11 0.433	3	LS 5
1-RY31-10/120		1-RY3x-10/120	120	2.9 0.114	10 0.394	2.7 0.106	15.4 0.606	5	LS 4

<sup>(1)</sup> Solder terminals are not compulsory

<sup>(#)</sup> Types are only available with matching to aluminum, ferritic or austenitic steel

# Series Y

with 3 measuring grids / rosettes

## RY41

0°/60°/120° rosette  
Temperature response matched to steel  
with  $\alpha = 10,8 \cdot 10^{-6}/K$  ( $12,8 \cdot 10^{-6}/^{\circ}F$ )

## RY4x

Temperature response matched to customer's choice  
see page 16

Illustrations show actual size  
(Data: Dimension a2 in mm/inch)

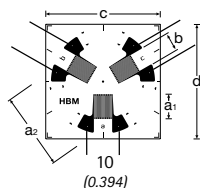
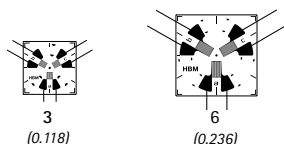

Contents per package: 5 pcs.

## RY7x

0°/60°/120° rosette  
Temperature response matched to customer's choice  
see page 16

Illustrations show actual size  
(Data: Dimension a2 in mm/inch)

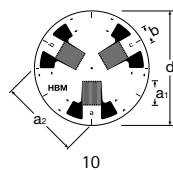

Contents per package: 5 pcs.

Types available ex stock		Variants	No-minal resistance	Dimensions (mm/inch)					Max. perm. effective bridge ex. voltage	Solder terminals
Steel	Aluminum			Measuring grid			Measuring grid carrier			
		Other	$\Omega$	a1	a2	b	c	d	V	
		1-RY4x-3/120 <sup>(#)</sup>	120	0.8 0.031	3 0.118	0.8 0.031	7 0.276	7 0.276	1.5	LS 7
1-RY41-6/120		1-RY4x-6/120	120	2 0.079	6 0.236	1.4 0.055	11 0.433	11 0.433	3	LS 5
1-RY41-10/120		1-RY4x-10/120	120	2.9 0.114	10 0.394	2.7 0.106	15.4 0.606	15.4 0.606	5	LS 4

Types available ex stock		Variants	No-minal resistance	Dimensions (mm/inch)				Max. perm. effective bridge ex. voltage	Solder terminals <sup>(1)</sup>
Steel	Aluminum			Measuring grid			Measuring grid carrier		
		Other	$\Omega$	a1	a2	b	d	V	
		1-RY7x-3/120 <sup>(#)</sup>	120	0.8 0.031	3 0.118	0.8 0.031	6.9 0.272	1.5	LS 7
		1-RY7x-6/120	120	2 0.079	6 0.236	1.4 0.055	11 0.433	3	LS 5
		1-RY7x-10/120	120	2.9 0.114	10 0.394	2.7 0.106	15.4 0.606	5	LS 4

<sup>(1)</sup> Solder terminals are not compulsory

<sup>(#)</sup> Types are only available with matching to aluminum, ferritic or austenitic steel

# Series Y

with 3 measuring grids / rosettes

## RY81

0°/45°/90° rectangular rosette  
Temperature response matched to steel  
with  $\alpha = 10,8 \cdot 10^{-6}/K$  ( $6,0 \cdot 10^{-6}/^{\circ}F$ )

## RY83

Temperature response matched to aluminum  
with  $\alpha = 23 \cdot 10^{-6}/K$  ( $12,8 \cdot 10^{-6}/^{\circ}F$ )

## RY8x

Temperature response matched to customer's choice  
see page 16

Illustrations show actual size  
(Data: grid length in mm/inch)

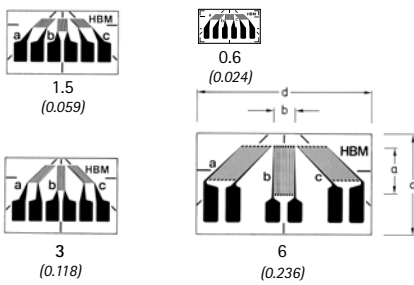

Contents per package: 5 pcs.

Types available ex stock		Variants	No-minal resistance	Dimensions (mm/inch)				Max. perm. effective bridge ex. voltage	Solder terminals (1)
Steel	Aluminum			Measuring grid		Measuring grid carrier			
		Other	$\Omega$	a	b	c	d	V	
		1-RY8x-0.6/120 <sup>(#)</sup>	120	0.6 0.024	1.2 0.047	4.8 0.189	8.7 0.343	1.6	LS 7
1-RY81-1.5/120		1-RY8x-1.5/120	120	1.5 0.059	1.4 0.055	8.2 0.323	14.6 0.575	2.5	LS 7
1-RY81-3/120	1-RY83-3/120	1-RY8x-3/120	120	3 0.118	1.1 0.043	9.7 0.382	14.6 0.575	3	LS 7
1-RY81-6/120		1-RY8x-6/120	120	6 0.236	3 0.118	13 0.512	22.9 0.902	7.5	LS 7
		1-RY8x-1.5/350 <sup>(#)</sup>	350	1.5 0.059	1.6 0.063	8.2 0.323	14.6 0.575	5	LS 7
		1-RY8x-3/350	350	3 0.118	1.2 0.047	9.7 0.382	14.6 0.575	5.5	LS 7
1-RY81-6/350		1-RY8x-6/350	350	6 0.236	2.8 0.11	13.1 0.516	22.9 0.902	13	LS 5

## RY91

0°/45°/90° - rosette, stacked measuring grids  
Temperature response matched to steel  
with  $\alpha = 10,8 \cdot 10^{-6}/K$  ( $6,0 \cdot 10^{-6}/^{\circ}F$ )

## RY93

Temperature response matched to aluminum  
with  $\alpha = 23 \cdot 10^{-6}/K$  ( $12,8 \cdot 10^{-6}/^{\circ}F$ )

## RY9x

Temperature response matched to customer's choice  
see page 16

Illustrations show actual size  
(Data: grid length in mm/inch)

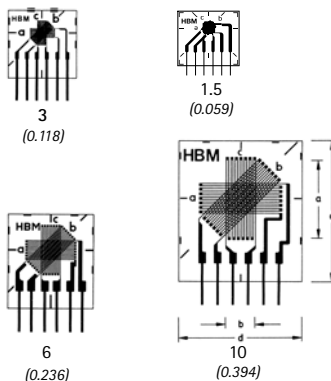

Contents per package: 5 pcs.

Types available ex stock		Variants	No-minal resistance	Dimensions (mm/inch)				Max. perm. effective bridge ex. voltage	Solder terminals
Steel	Aluminum			Measuring grid		Measuring grid carrier			
		Other	$\Omega$	a	b	c	d	V	
1-RY91-1.5/120		1-RY9x-1.5/120	120	1.5 0.059	1.3 0.051	9 0.354	8 0.315	1.5	LS 7
1-RY91-3/120	1-RY93-3/120	1-RY9x-3/120	120	3 0.118	1.3 0.051	9 0.354	9 0.354	2	LS 7
1-RY91-6/120	1-RY93-6/120	1-RY9x-6/120	120	6 0.236	2.6 0.102	12.5 0.492	11.4 0.449	4.5	LS 7
1-RY91-10/120		1-RY9x-10/120	120	10 0.394	4 0.157	17.5 0.689	16 0.63	7	LS 7
1-RY91-1.5/350		1-RY9x-1.5/350 <sup>(#)</sup>	350	1.5 0.059	1.5 0.059	8 0.315	9 0.354	2.5	LS 7
1-RY91-3/350	1-RY93-3/350	1-RY9x-3/350	350	3 0.118	1.5 0.059	9 0.354	9 0.354	3.5	LS 7
1-RY91-6/350	1-RY93-6/350	1-RY9x-6/350	350	6 0.236	2.6 0.102	12.5 0.492	11.4 0.449	6	LS 7
		1-RY9x-10/350	350	10 0.394	4 0.157	17.6 0.693	16 0.63	11.5	LS 7

(1) Solder terminals are not compulsory

(#) Types are only available with matching to aluminum, ferritic or austenitic steel

# Series Y

with 3 measuring grids / rosettes

## R Y101

0°/45°/90° rectangular rosette  
Temperature response matched to steel  
with  $\alpha = 10,8 \cdot 10^{-6}/K$  ( $6,0 \cdot 10^{-6}/^{\circ}F$ )

## R Y103

Temperature response matched to aluminum  
with  $\alpha = 23 \cdot 10^{-6}/K$  ( $12,8 \cdot 10^{-6}/^{\circ}F$ )

## R Y10x

Temperature response matched to customer's choice  
see page 16

Illustrations show actual size  
(Data: grid length in mm/inch)



1.5  
(0.059)

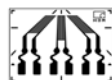

3  
(0.118)

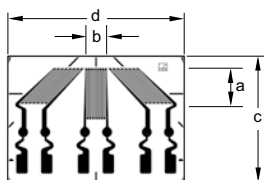

6  
(0.236)

Contents per package: 5 pcs.

Types available ex stock		Variants	No- minal resis- tance	Dimensions (mm/inch)				Max. perm. effective bridge ex. voltage	Solder terminals
Steel	Aluminum			Other	Measuring grid		Measuring grid carrier		
			$\Omega$	a	b	c	d	V	
1-RY101-1.5/120		1-RY10x-1.5/120	120	1.5 0.059	1.4 0.055	8.2 0.323	13.5 0.531	2.5	LS 7
	1-RY103-3/120	1-RY10x-3/120	120	3 0.118	1.1 0.043	9.7 0.382	13.5 0.531	3	LS 7
		1-RY10x-6/120	120	6 0.236	3 0.118	16.4 0.646	22.9 0.902	7.5	LS 4
1-RY101-1.5/350	1-RY103-1.5/350	1-RY10x-1.5/350 <sup>(#)</sup>	350	1.5 0.059	1.4 0.055	8.2 0.323	13.5 0.531	5	LS 7
1-RY101-3/350	1-RY103-3/350	1-RY10x-3/350	350	3 0.118	1.2 0.047	9.7 0.382	13.5 0.531	5.5	LS 7
1-RY101-6/350	1-RY103-6/350	1-RY10x-6/350 <sup>(2)</sup>	350	6 0.236	2.8 0.11	16.4 0.646	22.9 0.902	12	LS4

<sup>(1)</sup> Solder terminals are not compulsory

<sup>(2)</sup> With the temperature adaptation for quartz glass / composite (x=6) available ex stock (preferential gage)

<sup>(#)</sup> Types are only available with matching to aluminum, ferritic or austenitic steel



# Series Y

with 4 measuring grids / full bridges

## VY11

0°/90° - T full bridge  
 Temperature response matched to steel  
 with  $\alpha = 10,8 \cdot 10^{-6}/K$  ( $6,0 \cdot 10^{-6}/F$ )

## VY1x

Temperature response matched to customer's choice  
 see page 16

Illustrations show actual size  
 (Data: grid length in mm/inch)

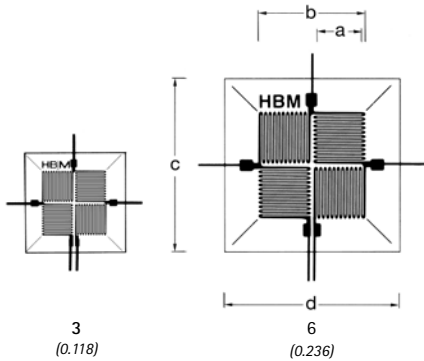

Contents per package: 5 pcs.

Types available ex stock		Variants	No-nominal resistance	Dimensions (mm/inch)				Max. perm. effective bridge ex. voltage	Solder terminals
Steel	Aluminum			Measuring grid		Measuring grid carrier			
		Other	$\Omega$	a	b	c	d	V	
		1-VY1x-3/120	120	3 0.118	7 0.276	13.5 0.531	13.5 0.531	6	LS 5/7
		1-VY1x-6/120	120	6 0.236	14 0.551	23 0.906	23 0.906	12	LS 5/7

## VY41

Shear/torsion full bridge  
 Temperature response matched to steel  
 with  $\alpha = 10,8 \cdot 10^{-6}/K$  ( $6,0 \cdot 10^{-6}/F$ )

## VY43

Temperature response matched to aluminum  
 with  $\alpha = 23 \cdot 10^{-6}/K$  ( $12,8 \cdot 10^{-6}/F$ )

## VY4x

Temperature response matched to customer's choice  
 see page 16

Illustrations show actual size  
 (Data: grid length in mm/inch)

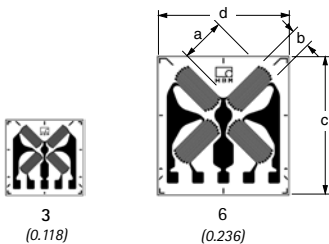

Contents per package: 5 pcs.

Types available ex stock		Variants	No-nominal resistance	Dimensions (mm/inch)				Max. perm. effective bridge ex. voltage	Solder terminals <sup>(1)</sup>
Steel	Aluminum			Measuring grid		Measuring grid carrier			
		Other	$\Omega$	a	b	c	d	V	
		1-VY41x-3/120	120	3 0.118	1.3 0.051	9.8 0.386	10 0.394	3.5	LS7
		1-VY41x-6/120	120	6 0.236	2.7 0.106	18 0.709	17 0.669	7.5	LS4
		1-VY41-3/350	350	3 0.118	1.2 0.047	9.8 0.386	10 0.394	6	LS7
		1-VY41x-6/350	350	6 0.236	2.7 0.106	18 0.709	17 0.669	13	LS4

<sup>(1)</sup> Solder terminals are not compulsory

# Series Y

with 4 measuring grids / diaphragm rosettes

## MY21

### Membran - Rosette

Temperature response matched to steel  
with  $\alpha = 10,8 \cdot 10^{-6}/K$  ( $6,0 \cdot 10^{-6}/^{\circ}F$ )

## MY2x

Temperature response matched to customer's choice  
see page 16

Illustrations show actual size  
(Data: Dimension a in mm/inch)

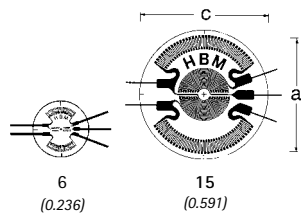

Types available ex stock		Variants	No- minal resis- tance	Dimensions (mm/inch)				Max. perm. effective bridge ex. voltage	Solder terminals (1)
Steel	Aluminum			a	b	Measuring grid carrier			
		c	d			V			
		1-MY2x-6/120	120	6 0.236	-	7.3 0.287	-	3.5	LS 7
1-MY21-15/350		1-MY2x-15/350	350	15 0.591	-	17 0.669	-	13	LS 5

Contents per package: 5 pcs.

# Series Y

## SG chains

### KY11

#### SG chain

Comprising 10 measuring grids in parallel to the chain axis and 1 compensating SG.  
Temperature response matched to steel  
with  $\alpha = 10,8 \cdot 10^{-6}/K$  ( $6,0 \cdot 10^{-6}/^{\circ}F$ )

### KY13

Temperature response matched to aluminum  
with  $\alpha = 23 \cdot 10^{-6}/K$  ( $12,8 \cdot 10^{-6}/^{\circ}F$ )

### KY1x

Temperature response matched to customer's choice  
see page 16

Illustrations show actual size  
(Data: Pitch t in mm/inch)

Contents per package:  
1 piece

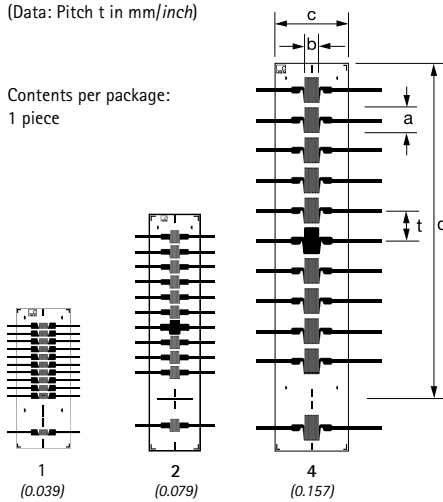

Types available ex stock		Variants	No- minal resis- tance	Dimensions (mm/inch)					Max. perm. effective bridge ex. voltage	Solder terminals
Steel	Aluminum	Other		Measuring grid		Measuring grid carrier		Pitch		
			$\Omega$	a	b	c	d	t	V	
1-KY11-1/120		1-KY1x-1/120 <sup>(#)</sup>	120	0.6 0.024	1 0.039	7.2 0.283	14.5 0.571	1 0.039	2	LS 7
1-KY11-2/120		1-KY1x-2/120	120	1.5 0.059	1.3 0.051	6.7 0.264	24.5 0.965	2 0.079	2.5	LS 7
1-KY11-4/120		1-KY1x-4/120	120	3 0.118	2.1 0.083	9.7 0.382	44.5 1.752	4 0.157	5	LS 7

### KY21

#### SG chain

Comprising 10 measuring grids vertical to the chain axis  
and 1 compensating SG.  
Temperature response matched to steel  
with  $\alpha = 10,8 \cdot 10^{-6}/K$  ( $6,0 \cdot 10^{-6}/^{\circ}F$ )

### KY23

Temperature response matched to aluminum  
with  $\alpha = 23 \cdot 10^{-6}/K$  ( $12,8 \cdot 10^{-6}/^{\circ}F$ )

### KY2x

Temperature response matched to customer's choice  
see page 16

Illustrations show actual size  
(Data: Pitch t in mm/inch)

Contents per  
package: 1 piece

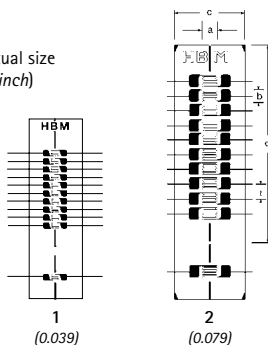

Types available ex stock		Variants	No- minal resis- tance	Dimensions (mm/inch)					Max. perm. effective bridge ex. voltage	Solder terminals
Steel	Aluminum	Other		Measuring grid		Measuring grid carrier		Pitch		
			$\Omega$	a	b	c	d	t	V	
1-KY21-1/120		1-KY2x-1/120 <sup>(#)</sup>	120	0.8 0.031	0.8 0.031	6.9 0.272	15 0.591	1 0.039	1.5	LS 7
1-KY21-2/120		1-KY2x-2/120	120	1.7 0.067	1.7 0.067	9.5 0.374	27 1.063	2 0.079	3.5	LS 7

<sup>(#)</sup> Types are only available with matching to aluminum, ferritic or austenitic steel

# Series Y

## SG chains

### KY41

**SG chain**  
 Comprising 10 measuring grids (5 parallel, 5 vertical to chain axis, alternating) and 1 compensating SG.  
 Temperature response matched to steel  
 with  $\alpha = 10,8 \cdot 10^{-6}/K$  ( $6,0 \cdot 10^{-6}/F$ )

### KY4x

Temperature response matched to customer's choice  
 see page 16

Illustrations show actual size  
 (Data: Pitch t in mm/inch)

Contents per package:  
 1 piece

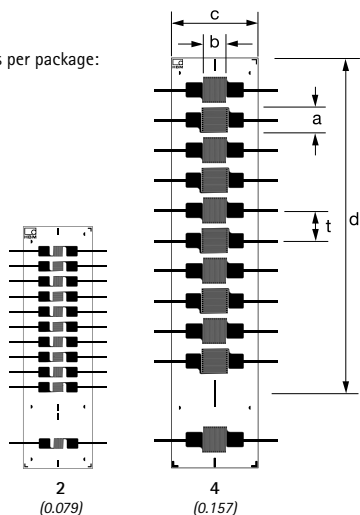

Types available ex stock		Variants	No-minal resistance	Dimensions (mm/inch)					Max. perm. effective bridge ex. voltage	Solder terminals
Steel	Aluminum			Measuring grid		Measuring grid carrier		Pitch		
		Other	$\Omega$	a	b	c	d	t	V	
		1-KY4x-2/120	120	1.2 0.047	1.3 0.051	9.2 0.362	24.5 0.965	2 0.079	2.5	LS 7
1-KY41-4/120		1-KY4x-4/120	120	3 0.118	3 0.118	11.5 0.453	44.5 1.752	4 0.157	6	LS 5

### KY3x

**SG rosette chain**  
 Comprising 5 rosettes each with  $3 \cdot 0^\circ/60^\circ/120^\circ$  measuring grids and 1 compensating SG.

Temperature response matched to customer's choice  
 see page 16

Illustrations show actual size  
 (Data: Pitch t in mm/inch)

Contents per package:  
 1 piece

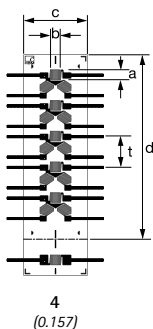

Types available ex stock		Variants	No-minal resistance	Dimensions (mm/inch)					Max. perm. effective bridge ex. voltage	Solder terminals
Steel	Aluminum			Measuring grid		Measuring grid carrier		Pitch		
		Other	$\Omega$	a	b	c	d	t	V	
		1-KY3x-4/120	120	1.2 0.047	1.3 0.051	8.3 0.327	24 0.945	4 0.157	2.5	LS 7

# Series Y

## SG chains

### KY5x

#### SG chain

Comprising 10 measuring grids with common connection in parallel to chain axis and 1 compensating SG.

Temperature response matched to customer's choice see page 16

Illustrations show actual size  
(Data: Pitch t in mm/inch)

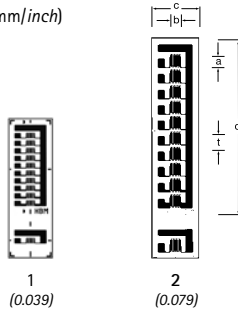

Contents per package: 5 pcs.

Types available ex stock		Variants	Nominal resistance	Dimensions (mm/inch)					Max. perm. effective bridge ex. voltage	Solder terminals
Steel	Aluminum			Other	Measuring grid		Measuring grid carrier			
			$\Omega$	a	b	c	d	t	V	
		1-KY5x-1/120 <sup>(#)</sup>	120	0.6 0.024	1.2 0.047	5.6 0.22	12.8 0.504	1 0.039	1.5	-
		1-KY5x-2/120	120	1.5 0.059	1.4 0.055	6 0.236	22.8 0.898	2 0.079	2.5	-

### KY6x

#### SG chain

Comprising 10 measuring grids with common connection in vertical to chain axis and 1 compensating SG.

Temperature response matched to customer's choice see page 16

Illustrations show actual size  
(Data: Pitch t in mm/inch)

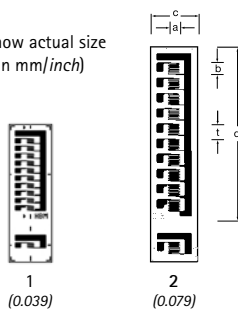

Contents per package: 5 pcs.

Types available ex stock		Variants	Nominal resistance	Dimensions (mm/inch)					Max. perm. effective bridge ex. voltage	Solder terminals
Steel	Aluminum			Other	Measuring grid		Measuring grid carrier			
			$\Omega$	a	b	c	d	t	V	
		1-KY6x-1/120 <sup>(#)</sup>	120	0.8 0.031	0.7 0.028	5.6 0.22	12.8 0.504	1 0.039	1.2	-
		1-KY6x-2/120	120	1.3 0.051	1.6 0.063	6 0.236	22.8 0.898	2 0.079	2.5	-

<sup>(#)</sup> Types are only available with matching to aluminum, ferritic or austenitic steel

# Series Y

## SG chains

### KY7x

**SG chain**  
Comprising 10 measuring grids with common connection in (5 parallel, 5 vertical to chain axis, alternating) and 1 compensation SG.

Temperature response matched to customer's choice see page 16

Illustrations show actual size (Data: Pitch t in mm/inch)

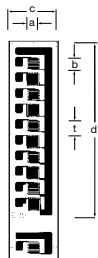

Contents per package: 5 pcs.

Types available ex stock		Variants	No-minal resistance	Dimensions (mm/inch)					Max. perm. effective bridge ex. voltage	Solder terminals
Steel	Aluminum			Measuring grid		Measuring grid carrier		Pitch		
		Other	$\Omega$	a	b	c	d	t	V	
		1-KY7x-2/120	120	1.3 0.051	1.5 0.059	6 0.236	22.8 0.898	2 0.079	2.5	-

### KY8x

**SG chain**  
Comprising 10 measuring grids parallel to the chain axis and 1 compensating SG.

Temperature response matched to customer's choice see page 16

Illustrations show actual size (Data: Pitch t in mm/inch)

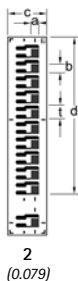

Contents per package: 5 pcs.

Types available ex stock		Variants	No-minal resistance	Dimensions (mm/inch)					Max. perm. effective bridge ex. voltage	Solder terminals
Steel	Aluminum			Measuring grid		Measuring grid carrier		Pitch		
		Other	$\Omega$	a	b	c	d	t	V	
		1-KY8x-2/120	120	1 0.039	1 0.039	5 0.197	21.7 0.854	2 0.079	2	-

### KY9x

**SG chain**  
Comprising 10 measuring grids vertical to the chain axis and 1 compensating SG.

Temperature response matched to customer's choice see page 16

Illustrations show actual size (Data: Pitch t in mm/inch)

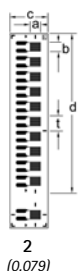

Contents per package: 5 pcs.

Types available ex stock		Variants	No-minal resistance	Dimensions (mm/inch)					Max. perm. effective bridge ex. voltage	Solder terminals
Steel	Aluminum			Measuring grid		Measuring grid carrier		Pitch		
		Other	$\Omega$	a	b	c	d	t	V	
		1-KY9x-2/120	120	1.2 0.047	1.2 0.047	5 0.197	21.7 0.854	2 0.079	2	-

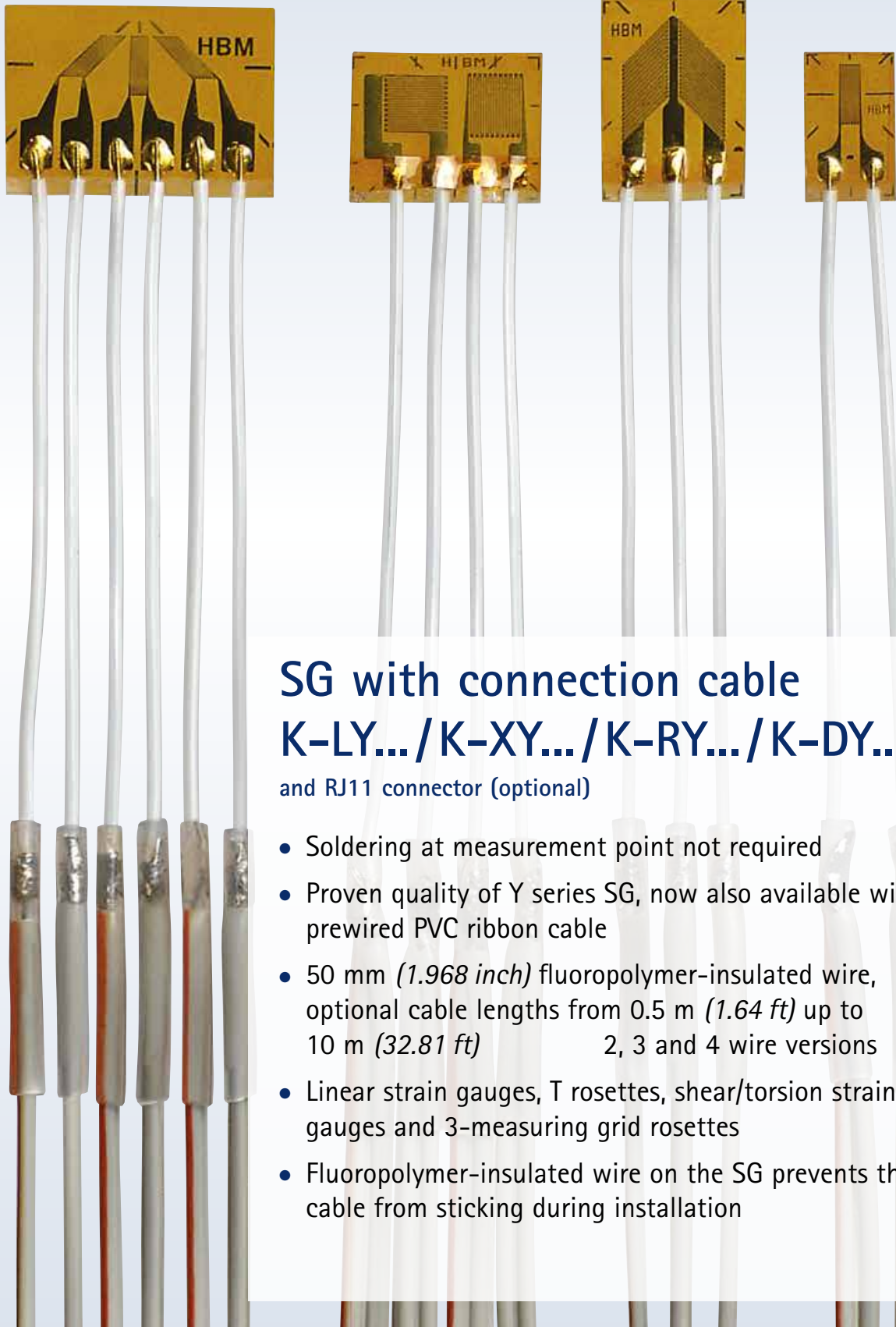

## SG with connection cable K-LY.../K-XY.../K-RY.../K-DY... and RJ11 connector (optional)

- Soldering at measurement point not required
- Proven quality of Y series SG, now also available with prewired PVC ribbon cable
- 50 mm (1.968 inch) fluoropolymer-insulated wire, optional cable lengths from 0.5 m (1.64 ft) up to 10 m (32.81 ft) 2, 3 and 4 wire versions
- Linear strain gauges, T rosettes, shear/torsion strain gauges and 3-measuring grid rosettes
- Fluoropolymer-insulated wire on the SG prevents the cable from sticking during installation





# SG with connection cable (incl. fluoropolymer-insulated wire) with 1 measuring grid

## K-LY41

Linear SG

Temperature response matched to steel  
with  $\alpha = 10,8 \cdot 10^{-6}/K$  ( $6,0 \cdot 10^{-6}/^{\circ}F$ )

## K-LY43

Temperature response matched to aluminum  
with  $\alpha = 23 \cdot 10^{-6}/K$  ( $12,8 \cdot 10^{-6}/^{\circ}F$ )

## K-LY4x

Temperature response matched to customer's  
choice, see page 16

Illustrations show actual size  
(Data: grid length in mm/inch)

Contents per package: 10 pcs.

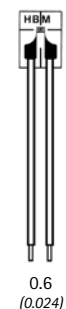
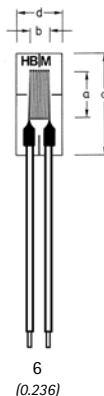
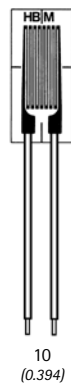
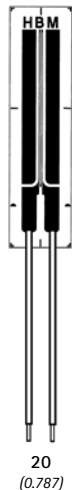
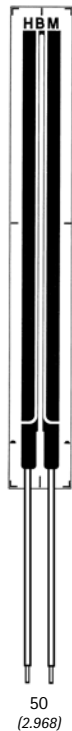
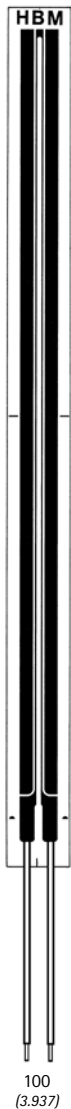

150  
(5.905)

100  
(3.937)

50  
(2.968)

20  
(0.787)

10  
(0.394)

6  
(0.236)

3  
(0.118)

1.5  
(0.059)

0.6  
(0.024)

Types available at short notice		Variants <sup>(1)</sup>	Nominal resistance	Dimensions (mm/inch)				Max. perm. effective bridge ex. voltage	Solder terminals
Steel	Aluminum			Measuring grid		Measuring grid carrier			
		Other	$\Omega$	a	b	c	d	V	not required
		K-LY4x-0.6/120 <sup>(#)</sup>	120	0.6 0.024	1.1 0.043	6 0.236	4 0.157	1.5	
		K-LY4x-1.5/120	120	1.5 0.059	1.2 0.047	7 0.276	4 0.157	2.5	
K-LY41-3/120		K-LY4x-3/120	120	3 0.118	1.2 0.047	8 0.315	5 0.197	4	
K-LY41-6/120	K-LY43-6/120	K-LY4x-6/120	120	6 0.236	2.7 0.106	13.9 0.547	5.9 0.232	8	
K-LY41-10/120		K-LY4x-10/120	120	10 0.394	4.9 0.193	18 0.709	8 0.315	14	
K-LY41-20/120		K-LY4x-20/120	120	20 0.787	0.2 0.02	31.8 1.252	8.2 0.323	7	
K-LY41-50/120		K-LY4x-50/120	120	50 1.969	0.8 0.031	63.6 2.504	8.2 0.323	12	
		K-LY4x-100/120	120	100 3.937	1 0.039	114.8 4.52	8.2 0.323	19	
		K-LY4x-150/120	120	150 5.906	1.2 0.047	165.6 6.52	8.2 0.323	25	
		K-LY4x-1.5/350 <sup>(#)</sup>	350	1.5 0.059	2.3 0.091	9.2 0.362	5.9 0.232	6.5	
		K-LY4x-3/350	350	3 0.118	2.5 0.098	10.9 0.429	5.9 0.232	9	
K-LY41-6/350		K-LY4x-6/350	350	6 0.236	2.8 0.11	13.9 0.547	5.9 0.232	15	
		K-LY4x-10/350	350	10 0.394	5 0.197	18 0.709	8 0.315	24	
		K-LY4x-3/700	700	3 0.118	2.7 0.106	10.9 0.429	5.9 0.232	13	
		K-LY4x-6/700	700	6 0.236	4.1 0.161	13.9 0.547	5.9 0.232	23	
		K-LY4x-10/700	700	10 0.394	5 0.197	18 0.709	8 0.315	33	
		K-LY4x-3/1000 <sup>(#)</sup>	1,000	3 0.118	2.7 0.106	10.9 0.429	5.9 0.232	16	
		K-LY4x-6/1000	1,000	6 0.236	4.2 0.165	13.9 0.547	5.9 0.232	27	
		K-LY4x-10/1000	1,000	10 0.394	5 0.197	18 0.709	8 0.315	40	

Available cable lengths  
see page 44

<sup>(1)</sup> Variants: Minimum order quantity: 3 packages

<sup>(#)</sup> Types are only available with matching to aluminum, ferritic or austenitic steel

# SG with connection cable (incl. fluoropolymer-insulated wire) with 2 measuring grids

## K-XY31

0°/90° T Rosette  
 Temperature response matched to steel  
 with  $\alpha = 10,8 \cdot 10^{-6}/K$  ( $6,0 \cdot 10^{-6}/F$ )

## K-XY33

Temperature response matched to aluminum  
 with  $\alpha = 23 \cdot 10^{-6}/K$  ( $12,8 \cdot 10^{-6}/F$ )

## K-XY3x

Temperature response matched to customer's choice  
 see page 16

Illustrations show actual size

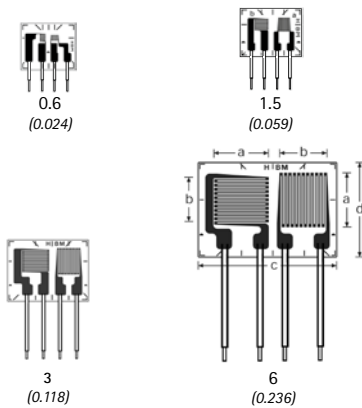

Contents per package: 5 pcs.

## K-XY4x

Shear/torsion half bridge  
 Temperature response matched to customer's choice  
 see page 16

Illustrations show actual size

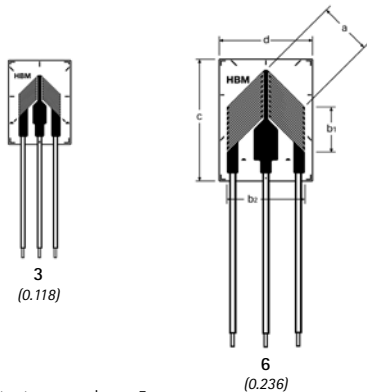

Contents per package: 5 pcs.

Types available at short notice		Variants <sup>(1)</sup>	No-minal resistance	Dimensions (mm/inch)				Max. perm. effective bridge ex. voltage	Solder terminals
Steel	Aluminum			Measuring grid		Measuring grid carrier			
		Other	$\Omega$	a	b	c	d	V	not required
		K-XY3x-0.6/120 <sup>(#)</sup>	120	0.6 0.024	1 0.039	7 0.276	6 0.236	1.5	
		K-XY3x-1.5/120	120	1.5 0.059	1.6 0.063	8 0.315	6.3 0.248	3	
		K-XY3x-3/120	120	3 0.118	3.2 0.126	10.5 0.413	8 0.315	5.5	
K-XY31-6/120		K-XY3x-6/120	120	6 0.236	6.3 0.248	17.5 0.689	12 0.472	11	
		K-XY3x-1.5/350 <sup>(#)</sup>	350	1.5 0.059	1.7 0.067	7.7 0.303	6.3 0.248	5	
K-XY31-3/350		K-XY3x-3/350	350	3 0.118	3.3 0.13	10.9 0.429	7.6 0.299	10	
	K-XY33-6/350	K-XY3x-6/350	350	6 0.236	6.5 0.256	18 0.709	12 0.472	20	

Types available at short notice		Variants <sup>(1)</sup>	No-minal resistance	Dimensions (mm/inch)					Max. perm. effective bridge ex. voltage	Solder terminals
Steel	Aluminum			Measuring grid			Measuring grid carrier			
		Other	$\Omega$	a	b1	b2	c	d	V	not required
		K-XY4x-3/120	120	3 0.118	3 0.12	5.4 0.21	11 0.433	8 0.315	5	
		K-XY4x-6/120	120	6 0.236	6 0.24	10.2 0.40	16 0.630	12.2 0.480	9.5	
		K-XY4x-3/350	350	3 0.118	4.2 0.17	5.6 0.22	11 0.433	8 0.315	9.5	
		K-XY4x-6/350	350	6 0.236	6 0.24	10 0.39	16 0.630	12.2 0.480	16	
		K-XY4x-3/700	700	3 0.118	4.2 0.17	5.6 0.22	11 0.433	8 0.315	13.5	
		K-XY4x-6/700	700	6 0.236	6.1 0.24	9.9 0.39	16 0.630	12.2 0.480	23	

<sup>(1)</sup> Variants: Minimum order quantity: 3 packages

<sup>(#)</sup> Types are only available with matching to aluminum, ferritic or austenitic steel

# SG with connection cable (incl. fluoropolymer-insulated wire) with 3 measuring grids

## K-RY61K

0°/45°/90° rectangular hole drilling rosette  
Temperature response matched to customer's choice  
see page 16

Illustrations show actual size

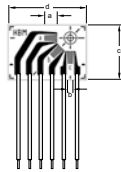

1.5  
(0.059)

Contents per package:  
5 pcs.

Types available at short notice		Variants <sup>(1)</sup>	Nominal resistance	Dimensions (mm/inch)				Max. perm. effective bridge ex. voltage	Solder terminals
Steel	Aluminum			Measuring grid		Measuring grid carrier			
		Other	Ω	a	b	c	d	V	not required
		K-RY6x-1.5/120K <sup>(2)</sup>	120	1.5 0.059	0.8 0.031	7.2 0.283	10.2 0.402	2	

## K-RY61R

0°/45°/90° rectangular hole drilling rosette  
Temperature response matched to customer's choice  
see page 16

Illustrations show actual size

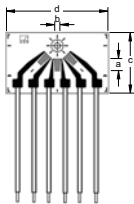

1.5  
(0.059)

Contents per package: 5 pcs.

Types available at short notice		Variants <sup>(1)</sup>	Nominal resistance	Dimensions (mm/inch)				Max. perm. effective bridge ex. voltage	Solder terminals
Steel	Aluminum			Measuring grid		Measuring grid carrier			
		Other	Ω	a	b	c	d	V	not required
		K-RY6x-1.5/120R <sup>(2)</sup>	120	1.5 0.059	0.8 0.031	8 0.315	13.5 0.531	2	

## K-RY81

0°/45°/90° rectangular rosette  
Temperature response matched to steel  
with  $\alpha = 10,8 \cdot 10^{-6}/K$  ( $6,0 \cdot 10^{-6}/^{\circ}F$ )

## K-RY83

Temperature response matched to aluminum  
with  $\alpha = 23 \cdot 10^{-6}/K$  ( $12,8 \cdot 10^{-6}/^{\circ}F$ )

## K-RY8x

Temperature response matched to customer's choice  
see page 16

Illustrations show actual size

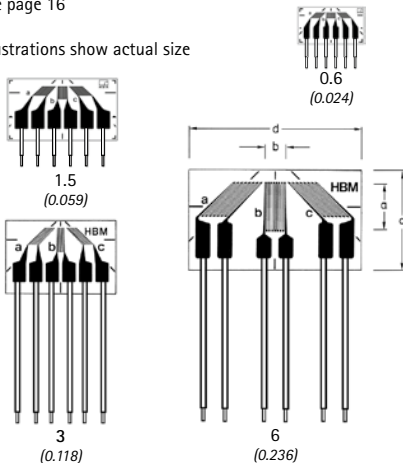

Contents per package: 5 pcs.

Types available at short notice		Variants <sup>(1)</sup>	Nominal resistance	Dimensions (mm/inch)				Max. perm. effective bridge ex. voltage	Solder terminals
Steel	Aluminum			Measuring grid		Measuring grid carrier			
		Other	Ω	a	b	c	d	V	not required
		K-RY8x-0.6/120 <sup>(4)</sup>	120	0.6 0.024	1.2 0.047	4.8 0.189	8.7 0.343	1.6	
		K-RY8x-1.5/120	120	1.5 0.059	1.3 0.051	8.2 0.323	14.6 0.575	2.5	
K-RY81-3/120		K-RY8x-3/120	120	3 0.118	1.1 0.043	9.7 0.382	14.6 0.575	3	
K-RY81-6/120	K-RY83-6/120	K-RY8x-6/120	120	6 0.236	3 0.118	13 0.512	22.9 0.902	7.5	
		K-RY8x-1.5/350 <sup>(4)</sup>	350	1.5 0.059	1.6 0.063	8.2 0.323	14.6 0.575	5	
		K-RY8x-3/350	350	3 0.118	1.2 0.047	9.7 0.382	14.6 0.575	5.5	
		K-RY8x-6/350	350	6 0.236	2.8 0.11	13.1 0.516	22.9 0.902	13	

<sup>(1)</sup> Variants: Minimum order quantity: 3 packages  
<sup>(2)</sup> Types are only available with temperature response matched to ferritic steel  
<sup>(4)</sup> Types are only available with matching to aluminum, ferritic or austenitic steel

# SG with connection cable

(incl. fluoropolymer-insulated wire) with double SG

## K-DY41

Double SG  
Temperature response matched to steel  
with  $\alpha = 10,8 \cdot 10^{-6}/K$  ( $6,0 \cdot 10^{-6}/^{\circ}F$ )

## K-DY4x

Temperature response matched to customer's choice  
see page 16

Illustrations show actual size

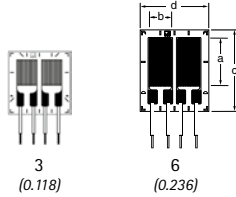

Contents per package: 5 pcs.

Types available at short notice		Variants <sup>(1)</sup>	No-minal resistance $\Omega$	Dimensions (mm/inch)				Max. perm. effective bridge ex. voltage V	Solder terminals  not required
Steel	Aluminum			Other	Measuring grid		Measuring grid carrier		
				a	b	c	d		
		K-DY4x-3/120	120	3 0.118	2,7 0.106	8,2 0.323	8 0.315	8,5	
		K-DY4x-6/120	120	6 0.236	3,2 0.126	10,7 0.421	9 0.354	13	
		K-DY4x-3/350	350	3 0.118	2,7 0.106	8,2 0.323	8 0.315	8,5	
K-DY41-6/350		K-DY4x-6/350	350	6 0.236	3,2 0.126	10,7 0.421	9 0.354	13	

<sup>(1)</sup> Variants: Minimum order quantity: 3 packages

# SG with connection cable and RJ11 connector

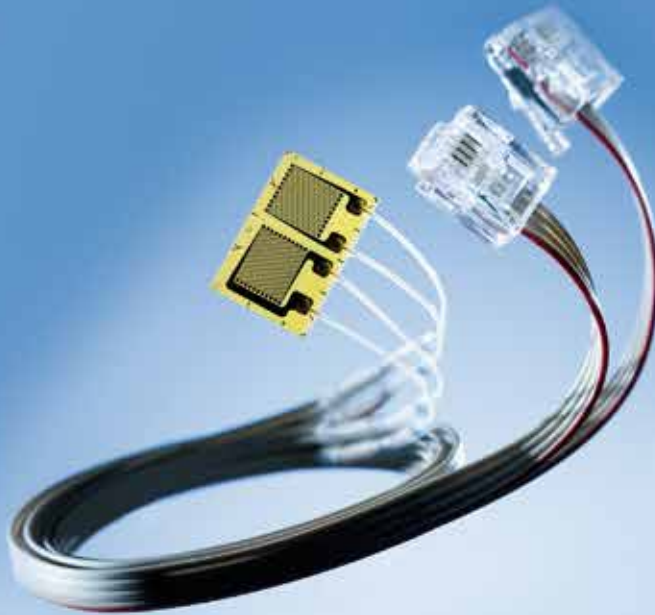

Available cable lengths  
(fitted PVC flat ribbon cable)

	K-LY4... <sup>(1)</sup> / K-XY3... <sup>(1)</sup> / K-DY4... <sup>(1)</sup>			
	2-	3-	4-	4- +RJ11 <sup>(1)</sup>
0,5 m	✓	✓	✓	✓
1 m	-	✓	✓	✓
2 m	-	✓	✓	✓
3 m	-	✓	✓	✓
5 m	-	✓	✓	✓
7,5 m	-	✓	✓	✓
10 m	-	✓	✓	✓

	K-XY4...			
	2-	3-	4-	4- +RJ11 <sup>(1)</sup>
0,5 m	-	✓	-	-
1 m	-	✓	-	-
2 m	-	✓	-	-
3 m	-	✓	-	-
5 m	-	✓	-	-
7,5 m	-	✓	-	-
10 m	-	✓	-	-

	K-RY6... / K-RY8... <sup>(1)</sup>			
	2-	3-	4-	4- +RJ11 <sup>(1)</sup>
0,5 m	✓	✓	✓	✓
1 m	-	✓	✓	✓
2 m	-	✓	✓	✓
3 m	-	✓	✓	✓
5 m	-	✓	✓	✓
7,5 m	-	✓	✓	✓
10 m	-	✓	✓	✓

### Advantages:

- No soldering on measuring point or cable end required
- No faulty measurements due to resistance changes in connector through 4-wire design
- Measurements without loss of time - after installation, measurements can start

<sup>(1)</sup> The option "connection cable in 4-wire design with RJ11 connector is available for the following SG: K-LY4..., K-XY3..., K-DY4... and K-RY8...

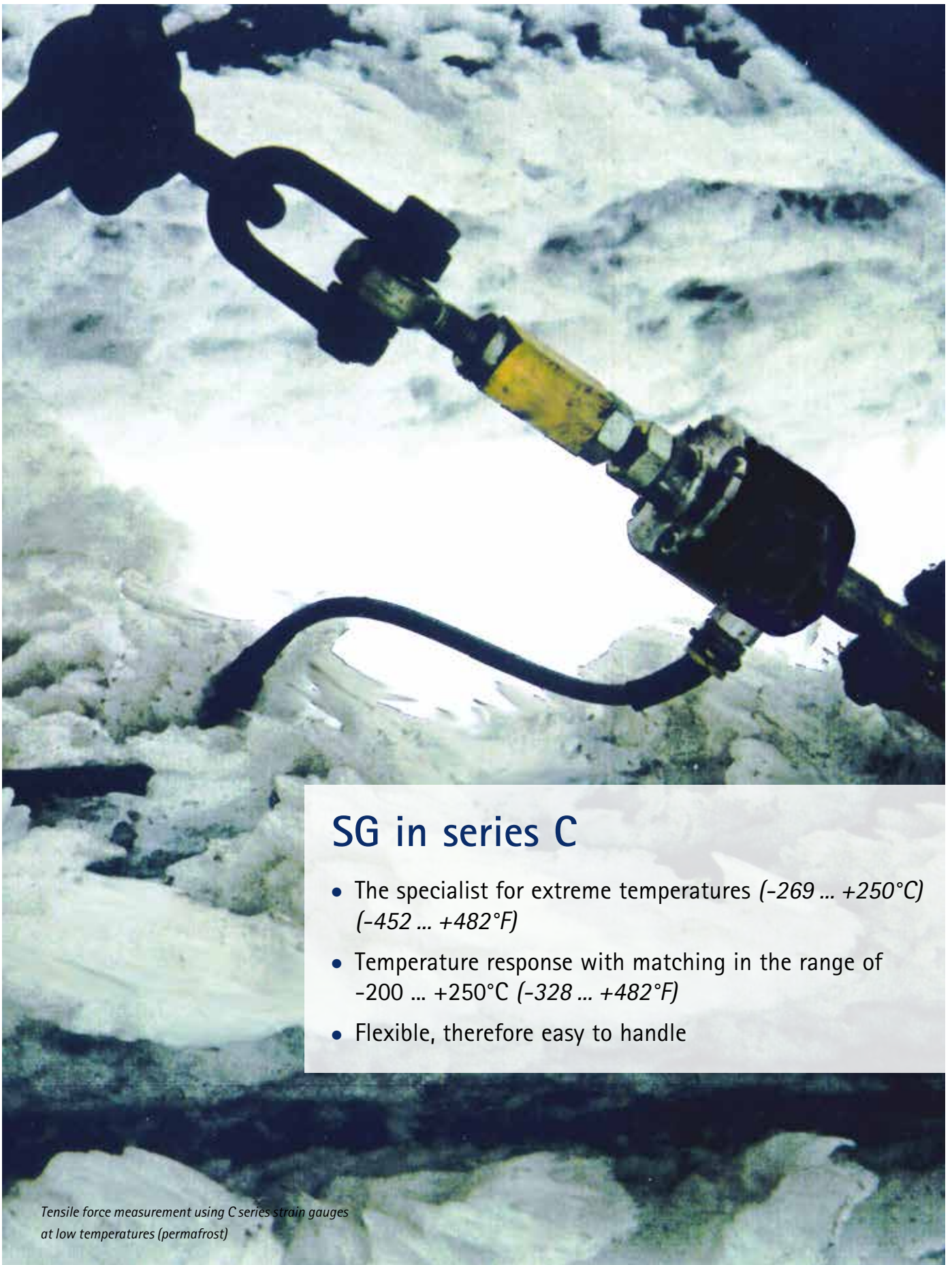

## SG in series C

- The specialist for extreme temperatures ( $-269 \dots +250^{\circ}\text{C}$ ) ( $-452 \dots +482^{\circ}\text{F}$ )
- Temperature response with matching in the range of  $-200 \dots +250^{\circ}\text{C}$  ( $-328 \dots +482^{\circ}\text{F}$ )
- Flexible, therefore easy to handle

*Tensile force measurement using C series strain gauges  
at low temperatures (permafrost)*

## Specifications – Series C

SG construction Measuring grid Material Thickness Carrier Material Thickness Covering agent Material Thickness Connections Nickel-plated in SGs without connection leads	μm (microinch)  μm (microinch)  μm (microinch)	Foil SG with embedded measuring grid  CrNi special alloy 5 (197)  Polyimide 45 ± 10 (1772 ± 394)  Polyimide 25 ± 12 (984 ± 472)  Nickel-plated Cu leads, approx. 30 mm long Strain relief solder tabs, 4-wire, copper-beryllium
Nominal resistance Resistance tolerance Gage factor Nominal value of gauge factor Gage factor tolerance Temperature coefficient of the gauge factor	Ω %   %	120 or 350, depending on SG type ± 0,3 without; ± 0,35 with connection leads approx. 2.2 Specified on each package ± 1 Specified on each package
Reference temperature Operating temperature range for static, i.e. zero point-related measurements for dynamic, i.e. non-zero point-related measurements	°C (°F)  °C (°F) °C (°F)	23 (73.4)  -200 ... +200 (-328 ... 392) -269 ... +250 (-452.2 ... 482)
Transverse sensitivity at reference temperature when using Z70 adhesive on SG type LC11-6/120	%	Specified on each package - 0.15
Temperature response Temperature response matched to thermal expansion coefficient α for ferritic steel α for aluminum Tolerance of temperature response Adaptation of temperature response in range	1/K 1/K 1/K °C (°F)	Specified on each package  10.8 · 10 <sup>-6</sup> 23 · 10 <sup>-6</sup> ± 0.6 · 10 <sup>-6</sup> -200 ... +250 (-328 ... 482)
Mechanical hysteresis <sup>(1)</sup> at reference temperature and strain $\varepsilon = \pm 1,000 \mu\text{m}/\text{m}$ (microstrain) on SG type LC11-6/120 at 1 <sup>st</sup> load cycle and adhesive Z 70 at 3 <sup>rd</sup> load cycle and adhesive Z 70	μm/m (microstrain) μm/m (microstrain)	1.25 0.75
Maximum elongation <sup>(1)</sup> at reference temperature using adhesive Z 70 on SG type LC11-6/120 Absolute strain value ε for positive direction Absolute strain value ε for negative direction	μm/m (microstrain) μm/m (microstrain)	20,000 ( Δ 2 %) 100,000 ( Δ 10 %)
Fatigue life <sup>(1)</sup> at reference temperature using adhesive Z 70 on SG type LC61-6/120 Achievable number of load cycles $L_w$ at alternating strain $\varepsilon_w = \pm 1,000 \mu\text{m}/\text{m}$ and zero point drift $\varepsilon_m \Delta \leq 300 \mu\text{m}/\text{m}$ (microstrain) $\varepsilon_m \Delta \leq 30 \mu\text{m}/\text{m}$ (microstrain)		>> 10 <sup>7</sup> (test was interrupted at 10 <sup>7</sup> ) > 10 <sup>7</sup> (test was interrupted at 10 <sup>7</sup> )
Minimum radius of curvature, longitudinal and transverse, at reference temperature within measuring grid area within solder tabs area Bonding material than can be used Cold-curing adhesives Hot-curing adhesives	mm (inch) mm (inch)	0.3 (0.012) 2 (0.079)  Z 70; X 60; X 280 EP 150; EP 310S

<sup>(1)</sup> The data depend on the various parameters of the specific application and are therefore stated for representative examples only.

# Series C

with 1 measuring grid

## LC11

Linear SG  
Temperature response matched to steel  
with  $\alpha = 10.8 \cdot 10^{-6}/K$  ( $6.0 \cdot 10^{-6}/^{\circ}F$ )

## LC1x

Temperature response matched to customer's choice  
see page 16

Illustrations show actual size  
(Data: grid length in mm/inch)

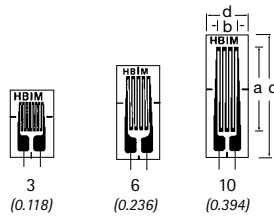

Contents per package: 10 pcs.

	Variants			No- minal resis- tance $\Omega$	Dimensions (mm/inch)				Max. perm. effective bridge ex. voltage V	Solder terminals
	Steel	Aluminum	Other		Measuring grid		Measuring grid carrier			
					a	b	c	d		
1-LC11-3/120				120	3 0.118	3.3 0.13	8.5 0.335	5.5 0.217	6	LS 5
1-LC11-6/120				120	6 0.236	3.2 0.126	12 0.472	5.5 0.217	9	LS 5
				120	10 0.394	3.2 0.126	16 0.63	5.5 0.217	11	LS 5
1-LC11-1.5/350				350	1.5 0.059	3.3 0.13	6.4 0.252	5.5 0.217	6	LS5
1-LC11-3/350				350	3 0.118	3.4 0.134	8.5 0.335	5.5 0.217	10	LS 5
1-LC11-6/350				350	6 0.236	3.3 0.13	12 0.472	5.5 0.217	14	LS 5
1-LC11-10/350				350	10 0.394	3.3 0.13	16 0.63	5.5 0.217	18	LS 5

## LC61

Linear SG  
Temperature response matched to steel  
with  $\alpha = 10.8 \cdot 10^{-6}/K$  ( $6.0 \cdot 10^{-6}/^{\circ}F$ )

## LC6x

Temperature response matched to customer's choice  
see page 16

Illustrations show actual size  
(Data: grid length in mm/inch)

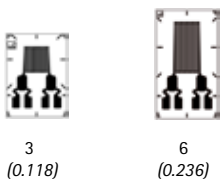

Contents per package: 10 pcs.

	Variants			No- minal resis- tance $\Omega$	Dimensions (mm/inch)				Max. perm. effective bridge ex. voltage V	Solder terminals
	Steel	Aluminum	Other		Measuring grid		Measuring grid carrier			
					a	b	c	d		
1-LC61-3/350				350	3 0.118	3.4 0.134	11 0.433	8 0.315	9.5	-
				350	6 0.236	3.4 0.134	14 0.551	8 0.315	16	-

Maximum elongation <sup>(2)</sup> at reference temperature using adhesive Z 70 on SG type LC61-3/350		
Absolute strain value $\epsilon$ for positive direction	$\mu\text{m/m}$ (microstrain)	25,000 ( $\Delta$ 2.5 %)
Absolute strain value $\epsilon$ for negative direction	$\mu\text{m/m}$ (microstrain)	50,000 ( $\Delta$ 5 %)
Minimum radius of curvature, longitudinal and transverse, at reference temperature within measuring grid area	mm (inch)	0.5 (0.02)
within solder tabs area	mm (inch)	10 (0.39)

<sup>(1)</sup> Only available with matching to aluminum or ferritic steel

<sup>(2)</sup> The data depend on the various parameters of the specific installation and are therefore stated for representative examples only.

...Other specifications as  
on Page 46

# Series C

with 2 measuring grids, with 3 measuring grids

## XC11

0°/90° T rosette  
Temperature response matched to steel  
with  $\alpha = 10.8 \cdot 10^{-6}/K$  ( $6.0 \cdot 10^{-6}/^{\circ}F$ )

## XC1x

Temperature response matched to customer's choice  
see page 16

Illustrations show actual size  
(Data: grid length in mm/inch)

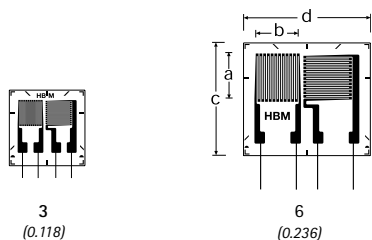

Contents per package: 5 pcs.

Types available ex stock	Variants			Nominal resistance $\Omega$	Dimensions (mm/inch)				Max. perm. effective bridge ex. voltage V	Solder terminals
	Steel	Aluminum	Other		Measuring grid		Measuring grid carrier			
					a	b	c	d		
			1-XY11-1.5/350	350	1.5 0.059	1.5 0.059	6 0.236	8.4 0.331	6	LS 5
			1-XC11-3/350	350	3 0.118	3.3 0.13	10 0.394	10 0.394	10	LS 7
			1-XC1x-6/350 <sup>(1)</sup>	350	6 0.236	6.4 0.252	16 0.63	18 0.709	20	LS 4

## RC11

0°/45°/90° rosette  
Temperature response matched to steel  
with  $\alpha = 10.8 \cdot 10^{-6}/K$  ( $6.0 \cdot 10^{-6}/^{\circ}F$ )

## RC1x

Temperature response matched to customer's choice  
see page 16

Illustrations show actual size  
(Data: Dimension a2 in mm/inch)

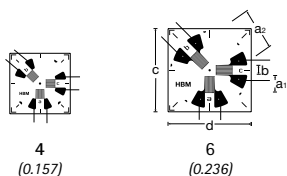

Contents per package: 5 pcs.

Types available ex stock	Variants			Nominal resistance $\Omega$	Dimensions (mm/inch)					Max. perm. effective bridge ex. voltage V	Solder terminals
	Steel	Aluminum	Other		Measuring grid			Measuring grid carrier			
					a <sub>1</sub>	a <sub>2</sub>	b	c	d		
			1-RC11-4/350	350	1.2 0.047	4 0.157	1.1 0.043	8 0.315	8 0.315	3.5	LS 7
			1-RC1x-6/350 <sup>(1)</sup>	350	2 0.079	6 0.236	1.3 0.051	11 0.433	11 0.433	5	LS 5

<sup>(1)</sup> Types are only available with matching to aluminum or ferritic steel





## SG in series G

- SG for special applications and manufacture of transducers
- Nominal resistances of 120 ohms and 350 ohms available
- Carrier material: Glass-fiber reinforced phenolic resin  
Measuring grid material: Constantan
- Leads: fitted as standard

*G series strain gauges for manufacture of transducers on different base bodies*

## Specifications – Series G

SG construction		Foil SG with embedded measuring grid
Measuring grid		Constantan foil
Material		3.8 (118) or 5 (197), depending on SG type
Thickness	$\mu\text{m}$ (microinch)	
Carrier		Phenolic resin, glass fiber reinforced
Material		$35 \pm 10$ (1,378 $\pm$ 394)
Thickness	$\mu\text{m}$ (microinch)	
Cover		Phenolic resin, glass fiber reinforced
Material		$25 \pm 8$ (984 $\pm$ 315)
Thickness	$\mu\text{m}$ (microinch)	
Connections		Nickel-plated copper leads, 0.2 or 0.3 x 0.06 x 30 mm
Nominal resistance	$\Omega$	120 or 350, depending on SG type
Resistance tolerance <sup>(2)</sup>	%	$\pm 0.35$
Gage factor		approx. 2
Nominal value of gauge factor		Specified on each package
Gage factor tolerance with 0.6 and 1.5 mm measuring grid length	%	$\pm 1.5$
with $\geq 3$ mm measuring grid length	%	$\pm 0.7$
Temperature coefficient of the gauge factor	$1/K$ ( $1/^{\circ}F$ )	approx. $(115 \pm 10) \cdot 10^{-6}$ ( $(64 \pm 5.5) \cdot 10^{-6}$ )
Nominal value of gauge factor temperature coefficient		Specified on each package
Reference temperature	$^{\circ}C$ ( $^{\circ}F$ )	23 (73)
Operating temperature range		
for static, i.e. zero point-related measurements	$^{\circ}C$ ( $^{\circ}F$ )	-70 ... +200 (-94 ... 392)
for dynamic, i.e. non-zero point-related measurements	$^{\circ}C$ ( $^{\circ}F$ )	-200 ... +200 (-328 ... 392)
Transverse sensitivity		Specified on each package
at reference temperature when using Z70 adhesive		
on SG type LG11-6/120	%	- 0.1
Temperature response		Specified on each package
Temperature response as required, adapted to coefficients of thermal expansion		
$\alpha$ for ferritic steel	$1/K$ ( $1/^{\circ}F$ )	$10.8 \cdot 10^{-6}$ ( $6.0 \cdot 10^{-6}$ )
$\alpha$ for aluminum	$1/K$ ( $1/^{\circ}F$ )	$23 \cdot 10^{-6}$ ( $12.8 \cdot 10^{-6}$ )
$\alpha$ for austenitic steel	$1/K$ ( $1/^{\circ}F$ )	$16 \cdot 10^{-6}$ ( $8.9 \cdot 10^{-6}$ )
Other adaptation available on request		
Tolerance of temperature response	$1/K$ ( $1/^{\circ}F$ )	$\pm 0.3 \cdot 10^{-6}$ ( $\pm 0.17 \cdot 10^{-6}$ )
Temperature range of temperature response matching	$^{\circ}C$ ( $^{\circ}F$ )	-10 ... +120 (14 ... 248)
Mechanical hysteresis <sup>(1)</sup>		
at reference temperature and strain $\epsilon = \pm 1,000 \mu\text{m}/\text{m}$ (microstrain)		
on SG type LG11-6/120		
at 1 <sup>st</sup> load cycle and adhesive EP 250	$\mu\text{m}/\text{m}$ (microstrain)	0.5
at 3 <sup>rd</sup> load cycle and adhesive EP 250	$\mu\text{m}/\text{m}$ (microstrain)	0.5
at 1 <sup>st</sup> load cycle and adhesive X 60	$\mu\text{m}/\text{m}$ (microstrain)	3
at 3 <sup>rd</sup> load cycle and adhesive X 60	$\mu\text{m}/\text{m}$ (microstrain)	1.5
on SG type LG11-3/350		
at 1 <sup>st</sup> load cycle and adhesive Z 70	$\mu\text{m}/\text{m}$ (microstrain)	1.6
at 3 <sup>rd</sup> load cycle and adhesive Z 70	$\mu\text{m}/\text{m}$ (microstrain)	0.8
Maximum elongation <sup>(1)</sup>		
at reference temperature using adhesive Z 70		
on SG type LG11-6/120		
Absolute strain value $\epsilon$ for positive direction	$\mu\text{m}/\text{m}$ (microstrain)	20,000 ( $\Delta$ 2 %)
Absolute strain value $\epsilon$ for negative direction	$\mu\text{m}/\text{m}$ (microstrain)	50,000 ( $\Delta$ 5 %)
Fatigue life <sup>(1)</sup>		
at reference temperature using adhesive Z 70		
on SG type LG61-6/120		
Achievable number of load cycles $L_w$ at alternating strain $\epsilon_w = \pm 1,000 \mu\text{m}/\text{m}$ and zero point drift		
$\epsilon_m \Delta \leq 300 \mu\text{m}/\text{m}$ (microstrain)		$\gg 10^7$
$\epsilon_m \Delta \leq 30 \mu\text{m}/\text{m}$ (microstrain)		$3 \cdot 10^6$
on SG type LG11-6/350		
$\epsilon_m \Delta \leq 300 \mu\text{m}/\text{m}$ (microstrain)		$\gg 10^7$
$\epsilon_m \Delta \leq 30 \mu\text{m}/\text{m}$ (microstrain)		$3 \cdot 10^6$
Minimum radius of curvature, longitudinal and transverse, at reference temperature	mm (inch)	3 (0.12)
Bonding material than can be used		
Cold-curing adhesives		Z 70; X 60; X 280
Hot-curing adhesives		EP 150; EP 310S

<sup>(1)</sup> The data depend on the various parameters of the specific installation and are therefore stated for representative examples only.

<sup>(2)</sup> With measuring grid lengths of 0.6 mm, the nominal resistance may deviate by  $\pm 1\%$

# Series G

with 1 measuring grid, 2 measuring grids

## LG11

Linear SG  
Temperature response matched to steel  
with  $\alpha = 10.8 \cdot 10^{-6}/K$  ( $6.0 \cdot 10^{-6}/^{\circ}F$ )

## LG13

Temperature response matched to aluminum  
with  $\alpha = 23 \cdot 10^{-6}/K$  ( $12.8 \cdot 10^{-6}/^{\circ}F$ )

## LG1x

Temperature response matched to customer's choice  
see page 16

Illustrations show actual size  
(Data: grid length in mm/inch)

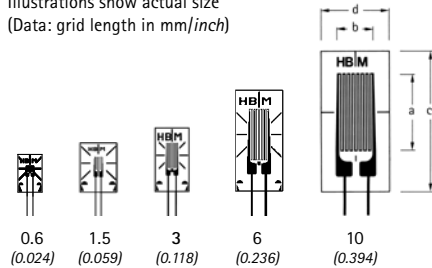

Contents per package: 10 pcs.

Types available ex stock		Variants	Nominal resistance	Dimensions (mm/inch)				Max. perm. effective bridge ex. voltage	Solder terminals
Steel	Aluminum			Measuring grid		Measuring grid carrier			
		Other	$\Omega$	a	b	c	d	V	
		1-LG1x-0.6/120 <sup>(#)</sup>	120	0.6 0.024	1 0.039	5 0.197	3.2 0.126	1.5	LS 7
		1-LG1x-1.5/120	120	1.5 0.059	1.2 0.047	6.5 0.256	4.7 0.185	2.5	LS 7
1-LG11-3/120		1-LG1x-3/120	120	3 0.118	1.6 0.063	8.5 0.335	4.5 0.177	4	LS 7
1-LG11-6/120		1-LG1x-6/120	120	6 0.236	2.8 0.11	13 0.512	6 0.236	8	LS 5
1-LG11-10/120		1-LG1x-10/120	120	10 0.394	4.6 0.181	18.5 0.728	9.5 0.374	13	LS 5
1-LG11-3/350		1-LG1x-3/350	350	3 0.118	1.6 0.063	8.5 0.335	4.5 0.177	7	LS 7
1-LG11-6/350	1-LG13-6/350	1-LG1x-6/350	350	6 0.236	2.8 0.11	13 0.512	6 0.236	13	LS 5
1-LG11-10/350		1-LG1x-10/350	350	10 0.394	5 0.197	18.5 0.728	9.5 0.374	23	LS 5

## XG11

T rosette  
Temperature response matched to steel  
with  $\alpha = 10.8 \cdot 10^{-6}/K$  ( $6.0 \cdot 10^{-6}/^{\circ}F$ )

## XG13

Temperature response matched to aluminum  
with  $\alpha = 23 \cdot 10^{-6}/K$  ( $12.8 \cdot 10^{-6}/^{\circ}F$ )

## XG1x

Temperature response matched to customer's choice  
see page 16

Illustrations show actual size  
(Data: grid length in mm/inch)

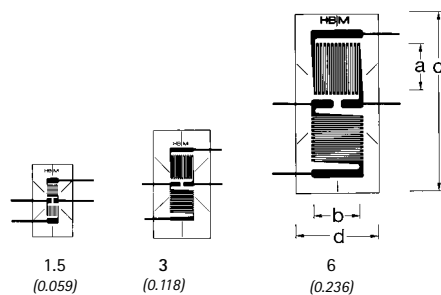

Contents per package: 5 pcs.

Types available ex stock		Variants	Nominal resistance	Dimensions (mm/inch)				Max. perm. effective bridge ex. voltage	Solder terminals
Steel	Aluminum			Measuring grid		Measuring grid carrier			
		Other	$\Omega$	a	b	c	d	V	
		1-XG1x-1.5/120	120	1.5 0.059	1.5 0.059	9 0.354	5 0.197	3	LS 5
1-XG11-3/120		1-XG1x-3/120	120	3 0.118	3.2 0.126	14.5 0.571	7.5 0.295	6	LS 4
1-XG11-6/120		1-XG1x-6/120	120	6 0.236	6.5 0.256	23.5 0.925	11 0.433	12	LS 5
1-XG11-3/350	1-XG13-3/350	1-XG1x-3/350	350	3 0.118	3.1 0.122	14.4 0.567	7.3 0.287	10	LS 4
1-XG11-6/350		1-XG1x-6/350	350	6 0.236	6.3 0.248	23.3 0.917	10.5 0.413	20	LS 5

<sup>(#)</sup> Types are only available with matching to aluminum, ferritic or austenitic steel

# Series G

with 2 measuring grids

## XG21

Shear/torsion half bridge  
 Temperature response matched to steel  
 with  $\alpha = 10.8 \cdot 10^{-6}/K$  ( $6.0 \cdot 10^{-6}/^{\circ}F$ )

## XG2x

Temperature response matched to customer's choice  
 see page 16

Illustrations show actual size  
 (Data: grid length in mm/inch)



1.5  
(0.059)

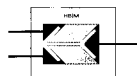

3  
(0.118)

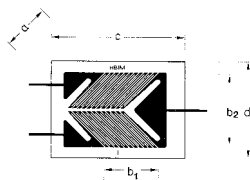

6  
(0.236)

Contents per package: 5 pcs.

Types available ex stock		Variants	No-minal resistance	Dimensions (mm/inch)					Max. perm. effective bridge ex. voltage	Solder terminals
Steel	Aluminum			Measuring grid			Measuring grid carrier			
		Other	$\Omega$	a	b	c	d	V		
		1-XG2x-1.5/120	120	1.5 0.06	1.7 0.07	2.5 0.10	6.8 0.268	4.5	2.5	LS 7
		1-XG2x-3/120	120	3 0.18	3.7 0.12	5.3 0.15	11.2 0.209	9.5	6	LS 5
		1-XG2x-6/120	120	6 0.44	7.9 0.37	10 0.24	17.5 0.311	12.7	11	LS4
1-XG21-3/350		1-XG2x-3/350	350	3 0.39	4.5 0.69	5.3 0.5	11.2 0.118	9.5	10	LS4
1-XG21-6/350		1-XG2x-6/350	350	6 0.18	7.9 0.21	10 0.44	17.5 0.374	12.7	19	LS 5

## SG in series V

- Encapsulated SG
- 3m (10 ft) stranded connection wire, PVC insulated
- High mechanical protection



*Experimental investigations  
on a railway rail*

# Series V

## Encapsulated SG with 3m (10 ft) stranded connection wire

### LV41

Linear SG Contents per package: 10 pcs.

### XV91

0°/90° T rosette Contents per package: 5 pcs.

### RV91

0°/45°/90° rosette Contents per package: 5 pcs.

Temperature response matched to steel with  $\alpha = 10,8 \cdot 10^{-6}/K$  ( $6,0 \cdot 10^{-6}/^{\circ}F$ )



Types available ex stock	Nominal resistance	Dimensions (mm/inch)				Max. perm. effective bridge ex. voltage
		Measuring grid		Measuring grid carrier		
		a	b	c	d	
Steel	$\Omega$				V	
1-LV41-3/120 (2-wire circuit) <sup>(1)</sup>	120	3 0.118	1.1 0.043	19 0.748	12 0.472	2
1-XV91-3/120 (2-wire circuit) <sup>(1)</sup>	120	3 0.118	1.4 0.055	24.5 0.965	20.5 0.807	2
1-RV91-3/120 (2-wire circuit) <sup>(1)</sup>	120	3 0.118	1.25 0.049	24.5 0.965	20.5 0.807	1
1-LV41-3/120V (4-wire circuit) <sup>(2)</sup>	120	3 0.118	1.1 0.043	19 <sup>(3)</sup> 0.748	12 <sup>(3)</sup> 0.472	2
1-XV91-3/120V (4-wire circuit) <sup>(2)</sup>	120	3 0.118	1.4 0.055	24.5 <sup>(3)</sup> 0.965	20.5 <sup>(3)</sup> 0.807	2
1-RV91-3/120V (4-wire circuit) <sup>(2)</sup>	120	3 0.118	1.25 0.049	24.5 <sup>(3)</sup> 0.965	20.5 <sup>(3)</sup> 0.807	1
1-LV41-3/350V (4-wire circuit) <sup>(2)</sup>	350	3 0.118	1.1 0.043	19 <sup>(3)</sup> 0.748	12 <sup>(3)</sup> 0.472	2
1-XV91-3/350V (4-wire circuit) <sup>(2)</sup>	350	3 0.118	1.4 0.055	24.5 <sup>(3)</sup> 0.965	20.5 <sup>(3)</sup> 0.807	2
1-RV91-3/350V (4-wire circuit) <sup>(2)</sup>	350	3 0.118	1.25 0.049	24.5 <sup>(3)</sup> 0.965	20.5 <sup>(3)</sup> 0.807	1

<sup>(1)</sup> Available for a limited time period only

<sup>(2)</sup> Availability planned for end of third quarter 2013

<sup>(3)</sup> The dimensions may be subjected to technical production changes

## Specifications – Series V

SG construction		Foil SG with embedded measuring grid and cable in plastic
potting		
Measuring grid		
Material	$\mu\text{m}$ (microinch)	Constantan foil
Thickness		5 (197)
Carrier		
Material	$\mu\text{m}$ (microinch)	Polyimide
Thickness		45 ± 10 (1772 ± 394)
Covering agent		
Material	$\mu\text{m}$ (microinch)	Polyimide
Thickness		25 ± 5 (984 ± 197)
Potting		
Material	mm (inch)	Plastic
Thickness		approx. 1.5 (0.04)
Connections		PVC-coated stranded connection wires, 3m long in two or four-wire circuit
Nominal resistance	$\Omega$	120; including stranded connection wire
Resistance tolerance	%	± 0.5
Gage factor		approx. 2
Nominal value of gauge factor		Specified on each package
Gage factor tolerance	%	± 1
Temperature coefficient of the gauge factor	1/K (1/°F)	approx. (115 ± 10) · 10 <sup>-6</sup> ((64 ± 5.5) · 10 <sup>-6</sup> )
Nominal value of gauge factor temperature coefficient	°C (°F)	Specified on each package (Reference temperature 23 (73.4))
Operating temperature range	°C (°F)	-30 ... +105 (-22 ... +221)
for static, i.e. zero point-related measurements	°C (°F)	-30 ... +105 (-22 ... +221)
for dynamic, i.e. non-zero point-related measurements	°C (°F)	-30 ... +105 (-22 ... +221)
Temperature response	°C (°F)	Specified on each package
Adaptation of temperature response in range		-10 ... +105 (-22 ... +221)
Maximum elongation <sup>(1)</sup>		
at reference temperature using adhesive Z 70		
on SG type LV41-3/120		
Absolute strain value $\epsilon$ for positive direction	$\mu\text{m}/\text{m}$ (microstrain)	20,000 ( $\Delta$ 2 %)
Absolute strain value $\epsilon$ for negative direction	$\mu\text{m}/\text{m}$ (microstrain)	50,000 ( $\Delta$ 5 %)
Minimum radius of curvature, longitudinal and transverse, at reference temperature	mm (inch)	100 (3.94)
Bonding material than can be used		Z 70; X 60; X280
Cold-curing adhesives		

<sup>(1)</sup> The data depend on the various parameters of the specific application and are therefore stated for representative examples only.

# Encapsulated SG with stranded wire

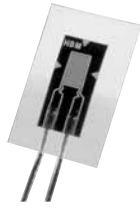

- IP 67<sup>(1)</sup> protection
- With 1m fluoropolymer-insulated stranded connection wire
- Moisture proof and resistant against chemicals<sup>(2)</sup> due to full encapsulation in special plastic material
- Excellent zero signal stability with changing moisture
- Optionally 2-wire or 4-wire circuit

## LE11

Encapsulated linear SG  
 Temperature response matched to steel  
 $\alpha = 10,8 \cdot 10^{-6} /K (6,0 \cdot 10^{-6}/^{\circ}F)$

Illustrations show actual size

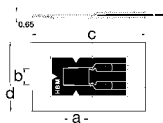

Contents per package: 5 pcs.

Types available ex stock	Nominal resistance	Dimensions (mm/inch)				Max. perm. effective bridge ex. voltage
		Measuring grid		Measuring grid carrier		
Steel	$\Omega$	a	b	c	d	V
1-LE11-3/350Z (2-wire circuit)	350	3 0.118	2 0.079	15 0.591	9 0.354	6
1-LE11-3/350V (4-wire circuit)	350	3 0.118	2 0.079	15 0.591	9 0.354	6

## Specifications – LE11

Type		LE11-3/350
SG construction		Foil SG, IP 67, resistant against chemicals <sup>2)</sup>
Measuring grid material		Constantan foil
Measuring grid length	mm (inch)	3 (0.12)
Carrier		
Material		Special plastic material
Thickness	$\mu\text{m}$ (microinch)	25 (984)
Covering material		Special plastic material, 25 $\mu\text{m}$ (984 microinch) thick
Thickness of complete SG	mm (inch)	0.65 (0.026)
Nominal resistance	$\Omega$	350
Resistance tolerance per package	%	$\pm 0.5$
Gage factor		approx. 2
Nominal value of gage factor		Specified on each package
Gage factor tolerance	%	$\pm 1$
Reference temperature	$^{\circ}\text{C}$ ( $^{\circ}\text{F}$ )	+ 23 (73.4)
Operating temperature range		
for installation with Z 70	$^{\circ}\text{C}$ ( $^{\circ}\text{F}$ )	-70 ... +120 (-94 ... +248)
for installation with EP 250/EP 310S/X 280	$^{\circ}\text{C}$ ( $^{\circ}\text{F}$ )	-200 ... +180 (-328 ... +356)
Temperature response matched to thermal expansion coefficient $\alpha$ for ferritic steel	1/K (1/ $^{\circ}\text{F}$ )	$10,8 \cdot 10^{-6} (6,0 \cdot 10^{-6})$
Temperature range of temperature response matching	$^{\circ}\text{C}$ ( $^{\circ}\text{F}$ )	- 10 ... + 120 (14 ... +248)
Transverse sensitivity at reference temperature when using Z70 adhesive	%	0.25
Minimum radius of curvature, longitudinal and transverse, at reference temperature	mm (inch)	3 (0.118)
Maximum elongation at reference temperature	$\mu\text{m}/\text{m}$ (microstrain)	$\pm 50,000 (\Delta \pm 5 \%)$
Fatigue life at reference temperature when using Z70 adhesive		
Achievable number of load cycles $L_W$ at alternating strain		
$\epsilon_{W} = \pm 1,000 \mu\text{m}/\text{m}$ and zero point drift	$\epsilon_m \Delta \leq 300 \mu\text{m}/\text{m}$ (microstrain) $\epsilon_m \Delta \leq 30 \mu\text{m}/\text{m}$ (microstrain)	$>> 10^7$ (test was interrupted at $10^7$ ) $> 10^7$ (test was interrupted at $10^7$ )
Connection cable, 1 m long		2 or 4 fluoropolymer-insulated stranded wires
Applicable bonding materials		Z 70, EP 150, EP 310S, X 280

<sup>(1)</sup> Please note the resistance of the adhesives used.

<sup>(2)</sup> Only concentrated acids (sulphuric acid, nitric acid) will destroy this special plastic material. High resistance against fuels and engine oils.

# Weldable SG

**Field of application:** Strain measurements at increased temperatures on weldable components on which – due to their size – strain gauge installation using hot curing adhesive is not possible. Use of strain gauges "on site" where the cleanliness required for bonding cannot be guaranteed (construction sites, production plants, etc.).

**Bonding:** Spot welding is a simple bonding method for strain gauges as hardly any preparations are necessary and very little practical experience is required of users.

**Layout design:** Y series foil strain gauge on carrier plate, covered with transparent silicone rubber; fitted with 0.5 m (1.64 ft) stranded connection wires

HBM recommends the mobile impulse welding machine c30 from Walter Heller GmbH.

Further information can be found under:  
[www.heller-schweisstechnik.de](http://www.heller-schweisstechnik.de)

## LS31

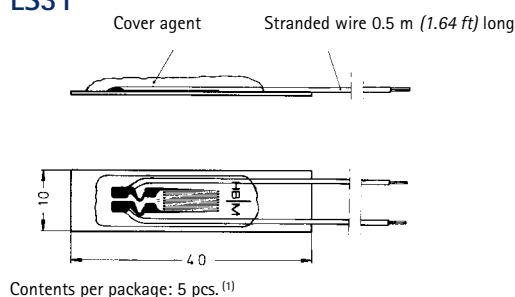

## Specifications – LS31

Type		LS 31-6/350
SG construction		Foil SG (quarter bridge) with polyimide carrier and constantan measuring grid, hot-bonded to carrier plate
Measuring grid length	mm (inch)	6 (0.236)
Carrier plate		
l x w	mm (inch)	40 x 10 (1.575 x 0.394)
Thickness	mm (inch)	0.1 (0.004)
Material		X 8 Cr 17 (1.4016)
Nominal resistance	Ω	350
Resistance tolerance per package	%	± 1 ; measured at end of cable
Gage factor		approx. 2
Nominal value of gauge factor		Specified on each package
Maximum permissible bridge excitation voltage		V 15
Reference temperature	°C (°F)	+ 23 (73.4)
Operating temperature range	°C (°F)	- 70 ... +150 (-328 ... +302)
Temperature response matched to thermal expansion coefficient α for ferritic steel	1/K (1/°F)	10.8 · 10 <sup>-6</sup> (6.0 · 10 <sup>-6</sup> )
Adaptation of temperature response in range	°C	-10 ... +120 (14 ... 248)
Minimum radius of curvature, longitudinal and transverse, at reference temperature	mm (inch)	75 (2.95)
Maximum elongation at reference temperature	μm/m (microstrain)	±3,000 (Δ ± 0.3 %)
Strain-related restoring force	$\frac{N}{1,000 \mu m/m}$ (lbf/microstrain)	< 250 (< 56)
Bonding method		Spot welding method

<sup>(1)</sup> Each package is supplied with two plates for welding exercises



# SG for high strains

**Field of application:** These strain gauges are used in all applications where they are extended or shortened by > 5%.

**Specifications:** Maximum elongation  $\pm 100,000 \mu\text{m/m}$  ( $= \pm 10\%$ ).

**Fatigue life:** less resistance to alternating loads than with Y series strain gauges.

**More specifications:** see page 19

## LD20

Linear strain gauges for high strains  
No matching of temperature response

Illustrations show actual size  
(Data: grid length in mm/inch)

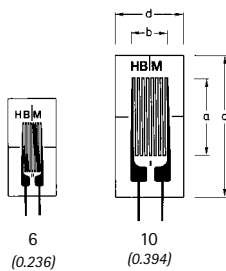

Contents per package: 10 pcs.

Types available ex stock	Variants	No- minal resis- tance	Dimensions (mm/ <i>inch</i> )				Max. perm. effective bridge ex. voltage	Solder terminals
			Measuring grid		Measuring grid carrier			
		$\Omega$	a	b	c	d	V	
1-LD20-6/120		120	6 0.236	2.8 0.11	13 0.512	6 0.236	8	LS 7
	1-LD20-10/120	120	10 0.394	4.6 0.181	18.5 0.728	9.5 0.374	13	LS 5
1-LD20-6/350		350	6 0.236	2.8 0.11	13 0.512	6 0.236	13	LS 7
	1-LD20-10/350	350	10 0.394	5 0.197	18.5 0.728	9.5 0.374	23	LS 5

# Strain gauges for integration in composites

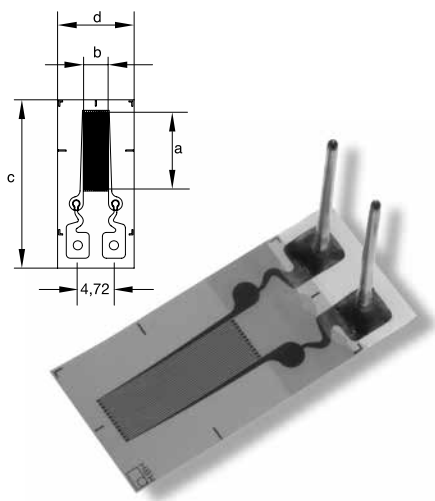

Types available ex stock Temperature response adapted to:	Nominal resistance	Dimensions (mm/ <i>inch</i> )				Max. perm. effective bridge ex. voltage	Solder terminals <sup>(1)</sup>
		Measuring grid		Measuring grid carrier			
Quartz	Ω	a	b	c	d	V	
1-LI66-10/350	350	10 0.394	3.8 0.15	22 0.866	10 0.394	2.5	-

## Specifications – LI66-10/350<sup>(1)</sup>

Configuration		Foil strain gauge with embedded measuring grid Application of strain via the carrier foil
Connections		Integrated solder tabs with strain relief, connected to vertically positioned, insulated connection pins
Measuring grid Material	Ω	Constantan
Thickness μm	μm ( <i>microinch</i> )	5 (197)
Carrier material Material	μm ( <i>microinch</i> )	Polyimide
Thickness		45 ± 10 (1.772 ± 394)
Basis foil Material	μm ( <i>microinch</i> )	Polyimide
Thickness		45 ± 10 (1.772 ± 394)
Nominal resistance	Ω	350
Resistance tolerance	%	±0.35
Gage factor		approx. 2 (specified on each package)
Gage factor tolerance	%	±1
Temperature coefficient of the gauge factor, approx.	1/K (1/°F)	(115±10) · 10 <sup>-6</sup> ((64 ± 5.5) · 10 <sup>-6</sup> )
Nominal value of gauge factor temperature coefficient		Specified on each package
Transverse sensitivity		Specified on each package
Reference temperature	°C (°F)	23 (73.4)
Operating temperature range	°C (°F)	-40 ... +180 (-40 ... +356)
for static measurements (zero point related measurements)	°C (°F)	-40 ... +180 (-40 ... +356)
for dynamic measurements (not zero point related measurements)		Specified on each package
Temperature response		Specified on each package
Temperature response adapted to coefficients of thermal expansion α for quartz glass/composite	1/K (1/°F)	0.5 · 10 <sup>-6</sup> (0.3 · 10 <sup>-6</sup> )
Temperature response tolerance	1/K (1/°F)	±0.3 · 10 <sup>-6</sup> (±0.17 · 10 <sup>-6</sup> )
Adaptation of temperature response in range	°C (°F)	-10 ... +120 (14 ... 248)
Max. elongation	μm/m (microstrain)	±50,000 (±5%)
Absolute strain value for positive direction	μm/m (microstrain)	±50,000 (±5%)
Absolute strain value for negative direction		
Fatigue life		
at reference temperature using a multi-directional CFP sample		
Ach. number of load cycles L <sub>w</sub> at alternating strain ε <sub>w</sub> = ± 1,000 μm/m u.		
Zero point variation ε <sub>m</sub> Δ < 100 μm/m (microstrain)		5,000,000
Zero point variation ε <sub>m</sub> Δ < 300 μm/m (microstrain)		10,000,000
Minimum radius of curvature (longitudinal and transverse)		
at reference temperature	mm ( <i>inch</i> )	0.3 (0.012)
within measuring grid area	mm ( <i>inch</i> )	∞
within solder tabs area		
Applicable bonding materials		Matrix resin

<sup>(1)</sup> All data according to OIML guideline IR62

# Temperature sensor

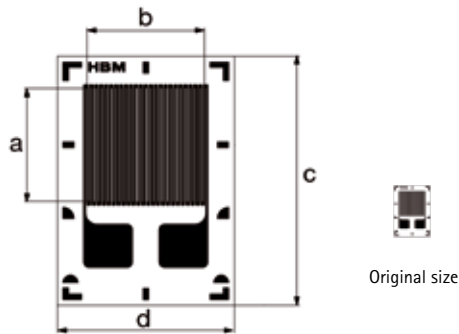

## Special features

- Rapid response time, through good thermal contact with component and very low heat capacity
- Can be installed like metallic strain gauges
- Can also be installed on curved surfaces
- Any resistance meter suitable for measured value acquisition

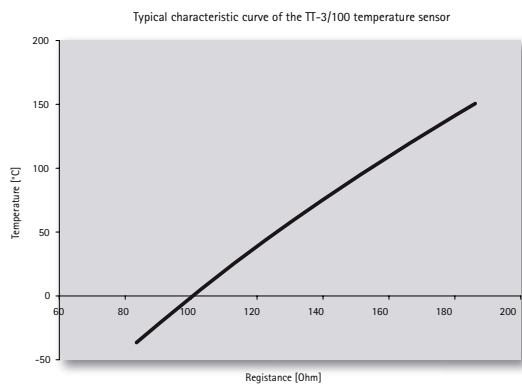

Types available ex stock:	Nominal resistance (at 0°C) (32°F)	Dimensions (mm/inch)			
		Measuring grid		Measuring grid carrier	
	Ω	a	b	c	d
1-TT-3/100	100	3 0.118	3.3 0.13	6.6 0.26	4.7 0.185

## Specifications – TT-3/100<sup>(1)</sup>

SG construction		Nickel temperature sensor (embedded)
Measuring grid Material Thickness	μm (microinch)	Nickel 5 (197)
Carrier material Material Thickness	μm (microinch)	Polyimide 40 ± 5 (1575 ± 197)
Cover Material Thickness	μm (microinch)	Polyimide 25 (9841)
Connections		Integrated solder tabs
Nominal resistance (at 0°C) Resistance tolerance of nominal resistance	Ω %	100 ±1
Specification of nominal resistance Specification of resistance tolerance	Ω %	stated on packaging ±0.3
Characteristic curve of the sensor Sensitivity error	%	stated on the packaging 0.5 (at reference temperature)
Temperature range	°C (°F)	-50 ... +180 (-58 ... +356)
Minimum radius of curvature (longitudinal and transverse) at reference temperature	mm (inch)	2, within solder tabs area 5
Applicable bonding materials Cold curing adhesives Hot curing adhesives		Z70, X60, X280 EP150, EP310S

<sup>(1)</sup> All data according to OIML guideline IR62

# Pressure measurement gauge

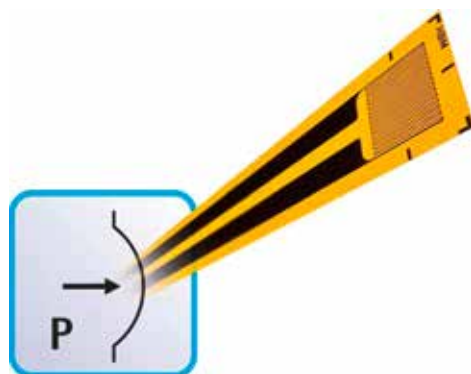

Illustrations show actual size  
Dimensions (in mm; 1 mm = 0.03937 inches)

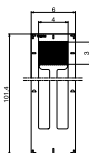

Contents per package: 10 pcs.

## Special features

- Transient pressure measurement
- Short rise time
- Bonded and non bonded application

Types available ex stock:	Nominal resistance	Dimensions (mm/inch)			
		Measuring grid		Measuring grid carrier	
	$\Omega$	a	b	c	d
1-PMS40-3/120_E	120	3 0.118	4 0.158	101.4 3.992	6 0.236

## Specifications – PMS40-3/120

SG construction	Pressure measurement gauge with embedded measuring grid		
Measuring grid Material Thickness	$\mu\text{m}$ (microinch)	Manganin 10 (394)	
Carrier Material Thickness	$\mu\text{m}$ (microinch)	Polyimide 45 $\pm$ 5 (1772 $\pm$ 197)	
Covering agent Material Thickness	$\mu\text{m}$ (microinch)	Polyimide 25 $\pm$ 12 (984 $\pm$ 472)	
Connections	Solder tabs, two wire configuration		
Nominal (rated) resistance Resistance tolerance	R	$\Omega$ %	120 $\pm$ 2
PMS output signal ( $\Delta R/R$ )	$a \cdot \Delta p + k \cdot \varepsilon + k \cdot \varepsilon_s(T)$		
Pressure sensitivity <sup>(1)</sup> ( $\Delta R/R = a \cdot \Delta p$ )	a	2.50 · 10 <sup>-6</sup> /bar	
Pressure sensitivity tolerance		%	$\pm$ 2
Gage factor <sup>(2)</sup> ( $\Delta R/R = k \cdot \varepsilon$ ) Gage factor tolerance	k	%	0.57 $\pm$ 4
Temperature sensitivity (apparent strain)	$\varepsilon_s(T)$	$\mu\text{m}/\text{m}$	$-619.4 + 50.1 \cdot T - 1.1 \cdot T^2 + 0.003 \cdot T^3 \pm (T - 20)$ [T in °C]
Rise time	$\tau$	$\geq$ 50 ns	
Maximum permissible effective bridge excitation voltage	$U_{\text{max}}$	V	3.5
Reference temperature	$T_{\text{ref}}$	°C (°F)	20 (68)
Operating temperature range		°C (°F)	-50 ... +180 (-58 ... 356)
Bonding material used <sup>(3)</sup> cold curing adhesives hot curing adhesives		Z70, X60, X280 EP150, EP310S	

<sup>(1)</sup> Tested under hydrostatic conditions up to 200bar. Further, non calibrated tests were run up to 2kbar.

<sup>(2)</sup> Specified up to 1,000 $\mu\text{m}/\text{m}$  strain.

<sup>(3)</sup> The gage factor must be taken into consideration for bonded applications. Non bonded installation of the PMS is possible.

# Crack propagation gauges

These strain gauges are used to determine the crack propagation on a component. HBM offers three different types: Types RDS20 and RDS40 consist of electrically separated resistors, i.e. as the crack extends, individual circuits will be interrupted.

Type RDS22 consisting of conductor tracks connected in parallel which will tear if the crack extends under the crack propagation gauge. This will gradually increase the electrical resistance of the strain gauge as the crack continues to extend.

This change in resistance can be measured using a resistance meter or a strain gauge amplifier (see connection diagram).

## RDS20, RDS22, RDS40

Crack propagation gauges  
Illustrations show actual size  
(Data: grid length in mm/inch)

### Design:

Carrier: Phenolic resin, glass fiber reinforced  
Thickness  $35 \pm 10 \mu\text{m}$  ( $1.378 \pm 394 \text{ microinch}$ )

Grid foil: Constantan foil, thickness  $5 \mu\text{m}$  ( $197 \text{ microinch}$ )

Product number of standard types	Resis- tance per link  $\Omega$	Dimensions (mm/inch)				Pitch t Link center/ Link center  mm (inch)	Number of links	Max. perm. effective excitation voltage  V
		Link length  a	Meas.- grid width  b	Measuring grid carrier  c      d				
1-RDS 20	13	20 <i>0.787</i>	22.5 <i>0.886</i>	28 <i>1.102</i>	25 <i>0.984</i>	1.15 <i>0.045</i>	20	1.5
1-RDS 22	44	22 <i>0.866</i>	5 <i>0.197</i>	27.8 <i>1.094</i>	6.8 <i>0.268</i>	0.1 <i>0.004</i>	50	0.8
1-RDS 40	28	40 <i>1.575</i>	8.4 <i>0.331</i>	47 <i>1.85</i>	10 <i>0.394</i>	0.85 <i>0.033</i>	10	2.5

Resistance tolerance  $\pm 20\%$

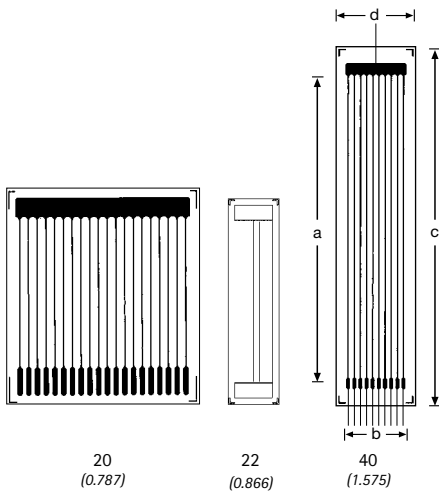

Contents per package: 5 pcs.

# Crack propagation gauges

## Connecting a crack propagation gauge

Connecting a crack propagation gauge

There are two different types of crack propagation gauges: RDS22 consisting of conductor tracks connected in parallel which will tear if the crack extends under the crack propagation gauge. This will gradually increase the electrical resistance of the strain gauge as the crack continues to extend. Types RDS20 and RDS40 consist of electrically separated resistor lines, i.e. as the crack extends, individual circuits will be interrupted. If these are contacted individually, the direction in which the gap extends can be detected.

The easiest way to detect the signals of crack propagation gauges (RDS) is to measure the resistance. Many amplifiers from HBM enable such direct resistance measurements to be taken (e.g. MGCplus or Spider8 with the appropriate modules).

The resulting resistance (R) of the RDS is dependent on the number of torn links and can easily be calculated. n identical resistors (R<sub>i</sub>) are connected in parallel:

$$R_n = \frac{R_i}{n}$$

If a grid line is interrupted, this is described by

$$R(n-1) = \frac{R_i}{(n-1)}$$

The measurement can also be taken using an amplifier for strain gauge measurements. The connection diagram shows how the RDS has to be complemented to obtain a resistance change that is inside the measuring range of an amplifier for strain gauge quarter bridges.

Temperature effects can be minimized using temperature stable fixed resistors or strain gauges as completion resistors. A higher sensitivity can be obtained by selecting a parallel resistor with a higher resistance value.

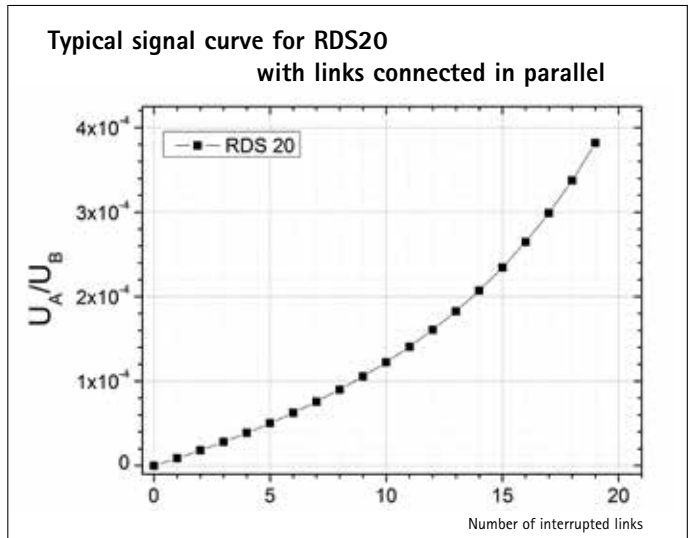
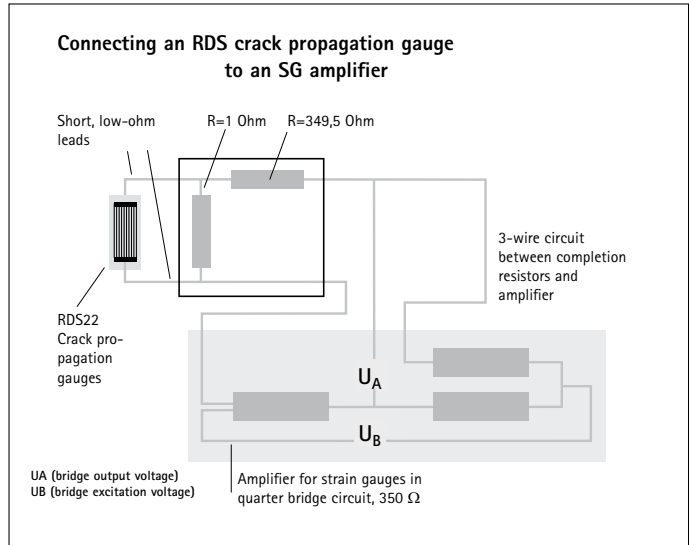

# SG for determination of residual stress

For determining residual stresses, the two following proven strain gauge based technologies are frequently used: the ring core method and the hole-drilling method. A common feature of both methods is that, after installation of the strain gauge rosettes onto the work piece, the residual stress condition is disturbed by a suitable action. In case of the ring core method, this is done by cutting a circular groove around the strain gauge rosette. In case of the hole-drilling method, a hole is drilled into the center of the rosette.

Following this action, residual stresses cause strains on the surface of the work piece, which are detected by the strain gauge and then used for calculating the residual stress state.

## Ring core method

The XY51 rosettes (for residual stresses with known principal direction) and RY51 (for residual stresses with unknown principal direction) are specifically designed for the ring core method. This process enables high precision measurements to be taken and the residual stresses to be represented in relation to the drilling depth.

### XY51

#### 0°/90° ring core rosette

Temperature response matched to steel  
with  $\alpha = 10,8 \cdot 10^{-6}/K$  ( $6,0 \cdot 10^{-6}/F$ )  
Operating temperature range: + 10°... + 60°C  
(+50°... +140°F)

Illustrations show actual size

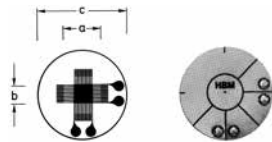

Contents per package: 5 pcs.

### RY51

#### 0°/45°/90° ring core rosette

Temperature response matched to steel  
with  $\alpha = 10,8 \cdot 10^{-6}/K$  ( $6,0 \cdot 10^{-6}/F$ )  
Operating temperature range: + 10°... + 60°C  
(+50°... +140°F)

Illustrations show actual size

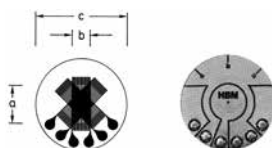

Contents per package: 5 pcs.

Types available ex stock		Variants	No- minal resistance	Dimensions (mm/inch)				Max. perm. effective bridge ex. voltage	Solder terminals
Steel	Aluminum			Other	Measuring grid		Measuring grid carrier		
			$\Omega$	a	b	c	d	V	
1-XY51-5/350			350	5 0.197	2,5 0.098	12 0.472	-	6,5	-

#### Specifications:

Resistance tolerance:  $\pm 1\%$   
Maximum elongation:  $\pm 10,000 \mu\text{m}/\text{m}$  (1%)  
More specifications: see page 19

As these strain gauges are covered by a print plate, they can be used on level or weakly curved surfaces only.

Types available ex stock		Variants	No- minal resistance	Dimensions (mm/inch)				Max. perm. effective bridge ex. voltage	Solder terminals
Steel	Aluminum			Other	Measuring grid		Measuring grid carrier		
			$\Omega$	a	b	c	d	V	
1-RY51-5/350			350	5 0.197	2,5 0.098	12 0.472	-	4,5	-

#### Specifications:

Resistance tolerance:  $\pm 1\%$   
Maximum elongation:  $\pm 10,000 \mu\text{m}/\text{m}$  (1%)  
More specifications: see page 19

As these strain gauges are covered by a print plate, they can be used on level or weakly curved surfaces only.

# SG for determination of residual stress

## Hole-drilling method according to the integral method

Using RY21 or, particularly easy to handle, RY61 and the associated drilling device, (page 68), it is possible to determine the residual stresses according to the integral method.

The result is the integral mean value of the residual stresses over the entire drilling depth.

### RY21

**0°/45°/90° hole-drilling rosette**  
 Temperature response matched to steel  
 with  $\alpha = 10,8 \cdot 10^{-6}/K$  ( $6,0 \cdot 10^{-6}/^{\circ}F$ )

Illustrations show actual size

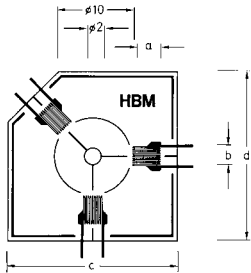

Contents per package: 5 pcs.

Types available ex stock		Variants	No-minal resistance	Dimensions (mm/inch)				Max. perm. effective bridge ex. voltage	Solder terminals
Steel	Aluminum			Other	Measuring grid		Measuring grid carrier		
			$\Omega$	a	b	c	d	V	
1-RY21-3/120			120	3 0.118	2,5 0.098	22,1 -	22,1 0.866	4,5	LS 5

### RY61

**0°/45°/90° hole-drilling rosette**  
 for use with HBM drilling device RY 61

Temperature response matched to steel  
 with  $\alpha = 10,8 \cdot 10^{-6}/K$  ( $6,0 \cdot 10^{-6}/^{\circ}F$ )  
 Operating temperature range: + 10°... + 60°C  
 (+50°... +140°F)

Illustrations show actual size

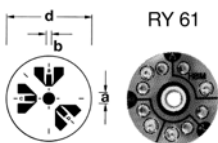

Contents per package: 5 pcs.

Types available ex stock		Variants	No-resistance	Dimensions (mm/inch)				Max. perm. effective bridge ex. voltage	Solder terminals (1)
Steel	Aluminum			Other	Measuring grid		Measuring grid carrier		
			$\Omega$	a	b	c	d	V	
1-RY61-1,5/120			120	1,5 0.059	0,8 0.031	-	12 0.472	2	LS 5

**Specifications:**

Resistance tolerance:  $\pm 1 \%$   
 Minimum radius of curvature: 1,000 mm  
 More specifications: see page 19

As these strain gauges are covered by a print plate, they can be used on level or weakly curved surfaces only.

(1) Solder terminals are not compulsory



# SG for determination of residual stress

## R Y61K

0°/45°/90° rectangular hole drilling rosette  
 Strain gauges with integrated contact surfaces  
 Temperature response matched to steel with  
 $\alpha = 10,8 \cdot 10^{-6}/K$  ( $6,0 \cdot 10^{-6}/^{\circ}F$ )

Illustrations show actual size

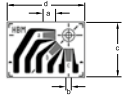

Contents per package: 5 pcs.

Types available ex stock		Variants	Nominal resistance	Dimensions (mm/inch)				Max. perm. effective bridge ex. voltage	Solder terminals <sup>(1)</sup>
Steel	Aluminum			Measuring grid		Measuring grid carrier			
		Other	$\Omega$	a	b	c	d	V	
1-RY61-1.5/120K			120	1,5 0.059	0,8 0.031	7,2 0.283	10,2 0.402	2	LS 7

## R Y61R

0°/45°/90° hole-drilling rosette  
 Temperature response matched to steel  
 with  $\alpha = 10,8 \cdot 10^{-6}/K$  ( $6,0 \cdot 10^{-6}/^{\circ}F$ )

Illustrations show actual size

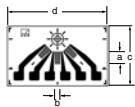

Contents per package: 5 pcs.

Types available ex stock		Variants	Nominal resistance	Dimensions (mm/inch)				Max. perm. effective bridge ex. voltage	Solder terminals <sup>(1)</sup>
Steel	Aluminum			Measuring grid		Measuring grid carrier			
		Other	$\Omega$	a	b	c	d	V	
1-RY61-1.5/120R			120	1,5 0.059	0,8 0.031	8 0.315	13,5 0.531	2	LS 7

<sup>(1)</sup> Solder terminals are not compulsory

# SG for determination of residual stress

## RY61S

0°/45°/90°hole-drilling rosette  
 Temperature response matched to steel  
 with  $\alpha = 10.8 \cdot 10^{-6}/K$  ( $6.0 \cdot 10^{-6}/^{\circ}F$ ) (see page 47).

Illustrations show actual size



Contents per package: 5 pcs.

Types available ex stock		Variants	No- minal resis- tance	Dimensions (mm/inch)				Max. perm. effective bridge ex. voltage	Solder terminals (1)
Steel	Aluminum			Measuring grid		Measuring grid carrier			
		Other	$\Omega$	a	b	c	d	V	
1-RY61-1.5/120S			120	1,5 0.059	0,8 0.031	-	10,2 0.402	2	LS 5

## RY61-3,2/120S

0°/45°/90°hole-drilling rosette  
 Temperature response matched to steel  
 with  $\alpha = 10.8 \cdot 10^{-6}/K$   
 ( $6.0 \cdot 10^{-6}/^{\circ}F$ ) (see page 47).

Illustrations show actual size

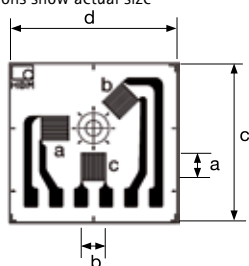

Contents per package: 5 pcs.

Types available ex stock		Variants	No minal resis- tance	Dimensions (mm/inch)				Max. perm. effective bridge ex. voltage	Solder terminals (1)
Steel	Aluminum			Measuring grid		Measuring grid carrier			
		Other	$\Omega$	a	b	c	d	V	
1-RY61-3.2/120S			120	3,2 0.126	3,2 0.126	20,9 0.823	22 0.866	10	LS 5

(1) Solder terminals are not compulsory

# SG for determination of residual stress

## VY61S

0°/45°/90°/135° hole-drilling rosette  
Temperature response matched to steel  
with  $\alpha = 10,8 \cdot 10^{-6}/K$  ( $6,0 \cdot 10^{-6}/^{\circ}F$ )

Illustrations show actual size

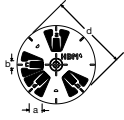

Contents per package: 5 pcs.

Types available ex stock		Variants	No- nominal resistance	Dimensions (mm/inch)				Max. perm. effective bridge ex. voltage	Solder terminals ( <sup>1)</sup> )
Steel	Aluminum			Measuring grid		Measuring grid carrier			
		Other	$\Omega$	a	b	c	d	V	
1-VY61-1.5/120S			120	1,5 0.059	0,8 0.031	-	10,2 0.402	2	LS 5

(<sup>1)</sup> Solder terminals are not compulsory

## RX61M

0°/45°/90° hole-drilling rosette, symmetrical  
Temperature response matched to steel  
with  $\alpha = 10,8 \cdot 10^{-6}/K$  ( $6,0 \cdot 10^{-6}/^{\circ}F$ )

Illustrations show actual size

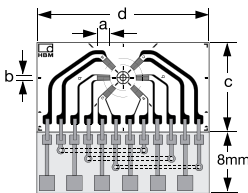

Contents per package: 5 pcs.

Types available ex stock		Variants	No- nominal resistance	Dimensions (mm/inch)				Max. perm. effective bridge ex. voltage	Solder terminals
Steel	Aluminum			Measuring grid		Measuring grid carrier( <sup>1)</sup> )			
		Other	$\Omega$	a	b	c	d	V	
1-RY61-1.5/120M			120	1,5	0,77	11,7	22,5	2,5	-
1-RY61-1.5/350M			350	1,5	0,77	11,7	22,5	4,5	-

(<sup>1)</sup> Dimensions of SG without circuit board

In residual stress analysis based on the hole drilling method, even small eccentricities can cause relatively large measurement errors. The symmetrical hole drilling rosette RY61M, with 6 measuring grids, has the advantage, due to the opposing radially arranged measurement grids, that any measurement errors in a common measurement direction can be almost completely compensated for.

### Characteristic features

- Self-compensating
- No additional connection work needed

# MTS 3000

System for automatically determining residual stress based on the hole drilling method



SINT Technology, a HBM partner, offers the measurement chain MTS3000 with which it is easy to implement the hole drilling method.

To create the hole, a cutter with a speed of 400,000 rpm is used, driven by a stepper motor. The strain changes arising due to the step by step drilling of the hole into the work piece will be detected by a strain gauge rosette (see page 65 and 67) specifically designed for this process.

## Integral hole drilling method

Drilling device for hole drilling rosette 1-RY61-1.5/120



The drilling device is used to apply the hole in the center of the installed hole drilling rosette.

It comprises a magnetic holder, a centering pin, a shaft drill, and a universal coupling:

Order No.: 1-RY61<sup>(1)</sup>

Spare drill for material hardness up to 30 HRC:

Order No.: 1-8410.0019<sup>(1)</sup>

Carbide drill for material hardness up to 45 HRC:

Order No.: 2-9219.9133<sup>(1)</sup>

<sup>(1)</sup> Available for a limited time period only

# Customized strain gauges

- You have special requirements which cannot be met by a strain gauge from our standard product range?
- You are looking for a strain gauge equivalent to the one you currently use?
- You have designed your own strain gauge?

Contact us, we will produce customized strain gauges according to your requirements! From quantities of 20 packages onwards. Please use the request form included in our strain gauge price list or send your request or layout direct via e-mail to: [info@hbm.com](mailto:info@hbm.com)

Please also refer to our catalog  
"Strain gauges for manufacturers of transducers"



Diaphragm rosette strain gauges

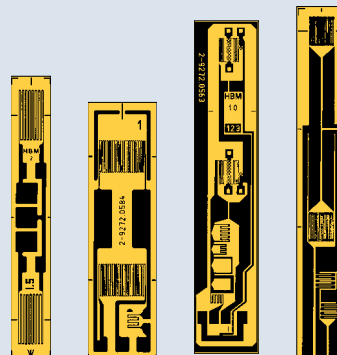

Half bridge strain gauges

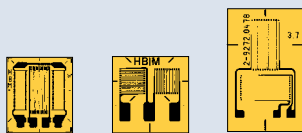

T strain gauges

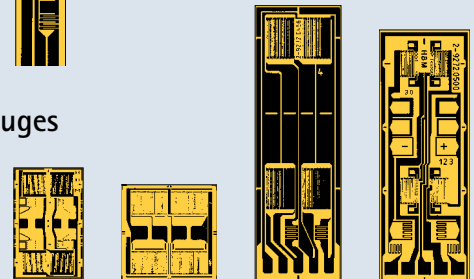

Full bridge strain gauges

# SG fastening materials

The most usual way to connect strain gauges to the test object is by bonding. It is essential that adhesives are used that are application-specific and that meet the following requirements:

- Loss-free transfer of deformation of the test object to the strain gauge
- Stable behavior across a temperature and strain range which is as wide as possible
- The strain gauge and test object must not be chemically attacked

All adhesive packages from HBM include the adhesive and the accessories (such as fluoropolymer release film) required for bonding and, in addition, a safety data sheet. Your criteria for adhesive selection should be:

- Application temperature
- Material of the measuring body and recommendations for the relevant strain gauge
- Requirements for long-term stability and reproducibility
- Surface roughness



Z 70

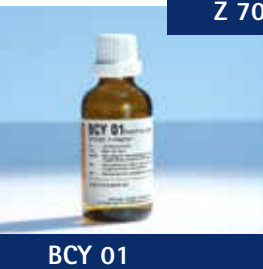

BCY 01



X 60



X 280



X 120



EP 150



EP 310 S

## Hot curing adhesives

Hot curing adhesives can be used where the test object can be brought up to the curing temperature. This is generally possible in the manufacture of transducers, but also where installations can be made before machine assembly or where the machine can be disassembled. Hot curing adhesives meet higher quality demands and can be used within a greater temperature range than cold curing adhesives.

Adhesive	Description	Suitable SG	Pot life at room temperature (RT)
<b>Cold curing</b> Z 70 Order No.: 1-Z70 for optional use with Z 70 1-BCY01	Cyanacrylate adhesive, low viscosity, Accelerator for Z 70	optimum: Y, C, LD, LE, V SG residual stress good: K, G	-
X 60 Order No.: 1-X60	Methyl metacrylate Two-component adhesive pasty, also suitable for absorbent or uneven surfaces	optimum: Y, C, LD, V SG residual stress good: K, G, LS	ca. 5 minutes
X 280 Order No.: 1-X 280	Two-component Epoxy resin adhesive for smooth and absorbent surfaces	optimum: Y, C, LD, LE, V good: G, K	30 minutes
X 120 Order No.: 1-X120	Viscoplastic two-component adhesive for installing optical fibers	OptiMet PKF	90 minutes
<b>Hot curing</b> EP 150 Order No.: 1-EP150	Single-component Epoxy resin adhesive Low viscosity	optimum: Y, C, K, G, LD, LE good: SG residual stress	-
EP 310 S Order No.: 1-EP310S	Two-component Epoxy resin adhesive low viscosity	optimum: Y, C, K, G, LD, LE good: SG residual stress	1 month (at RT) 6 months (at + 2°C (+36°F))

## Cold curing adhesives

Cold curing adhesives are easy to use and can be processed at minimum cost and effort as they harden under normal ambient conditions. If they have short curing times they are also called "superglues". The preferred field of application is in experimental stress analysis. However, if the temperature around the measuring point is higher than about 80°C (176°F), we recommend using a hot curing adhesive or a heat resistant cold curing epoxy resin adhesive (X280).

## Spot weld joints

Spot weld joints are only possible with the special strain gage type LS 31, and if the test object is of a weldable material. This method is particularly suitable for applications where cleanliness required for bonding cannot be guaranteed. Hardly any preparations or experience are necessary. However, it is essential to follow the process instructions supplied with the strain gages.

Storage life Dry	Curing temperature	Curing time <sup>(3)</sup>	Contact pressure (N/mm <sup>2</sup> )	Temperature limits			Delivery quantity
				lower	upper static <sup>(1)</sup>	upper dynamic <sup>(2)</sup>	
6 months (refrigerator)	5°C (41°F) <sup>(3)</sup> 20°C (68°F) 30°C (86°F)	10 minutes 1 minute 0.5 minutes	thumb pressure	-55°C (-67°F) (briefly -70°C (-94°F))	+100°C (212°F)	+120°C (248°F)	10 ml ≈ 150 – 200 DMS
12 months (room temperature)	0°C (32°F) 20°C (68°F) 35°C (95°F)	60 minutes 10 minutes 2 minutes	thumb pressure	-200°C (-328°F)	+60°C (140°F)	+80°C (176°F)	Components A= 0.1 kg B = 80 ml  Other container sizes, see price list
6 months (refrigerator)	RT ... 95°C (203°F)	8 h ... 1 h	0.05 ... 2.0	-200°C (-328°F)	+200°C (392°F)	+280°C (536°F)	6 double bags à 10 g = 60 g
12 months (room temperature)	room temperature 65°C (149°F)	7 Tage 2 h	-	-55°C (-67°F)	+120°C (248°F)		Two-component cartridge 50 ml A=16,6 ml B=33,3 ml
12 months (refrigerator)	160 ... 190 °C (320 ... 374°F)	6 h ... 1 h	0.3 ... 0.5	-70 °C (-94°F)	+150 °C (302°F)	+150 °C (302°F)	2 x 20 ml bottles (EP 150)
6 months (room temperature)	120 ... 200°C (248 ... 392°F)	6 h ... 0.5 h	0.1 ... 0.5	-270°C (-454°F)	+260°C (500°F)	+310°C (590°F)	Components A = 60 ml B = 30 ml

<sup>(1)</sup> Zero-point based measurement

<sup>(2)</sup> Non-zero-point based measurement

<sup>(3)</sup> Curing condition: Relative humidity of 30 - 80%

## SG covering materials

The quality of a measuring point with strain gauges is not only dependent on the strain gauge itself but mainly on the type of installation and its implementation. A properly functioning measuring point requires thorough preparation of the installation surface, careful bonding, correct connections and also a protective covering. It is therefore important to provide the user with all necessary aids. The HBM strain gauge accessory product range offers everything necessary for good strain gauge installation.

### SG covering agents

In general, it is recommended that strain gauges be protected against external effects such as humidity or mechanical damage since even small fluctuations in the atmospheric humidity affect the measured signal of a strain gauge.

Suitable covering agents should have only minimum effects on the measuring point. The strain gauge and test object must not be attacked. Criteria for selecting the appropriate covering agent should be:

- Application temperature
- Media surrounding the measuring point

The following table will help in the selection of a suitable means of measuring point protection, which for special requirements can also be carried out in several layers. For instance, it would make sense to apply AK22, with - in extremely humid environments - additional sealing by ABM 75. Caution: NG 150 cannot be combined with PU 140. Please ensure, in the case of multi-layer covering, that the second layer may only be applied after full curing of the first layer and that it should overlap on all sides. All HBM covering agents are supplied with a safety data sheet.



AK 22



ABM 75



SG covering materials	Temperature range of resistance in air in °C	Package contents	One Package sufficient for approx.	Application method	Curing conditions	Storage life at room temperature	Components
<b>AK 22</b> Viscous putty Order No.: 1-AK22	-30 ... +120 (-22°F ... +248°F)	1 kg (2.2 lb)	30 SGs	kneading on by hand	-	2 years	viscous, kneadable, sticky putty
<b>ABM 75</b> Aluminum foil with kneading compound Order No.: 1-ABM75	-196 °C ... +75 °C (-321°F ... +167°F)	11 pcs. 205 mm x 100 mm (8.07 x 3.94 in.)	200 SGs	pressing on by hand	-	unlimited	0.05 mm thick aluminum foil, coated with 3 mm thick kneading compound
<b>NG 150<sup>(1)</sup></b> Nitrile rubber Order No.: 1-NG150	-269 °C ... +150 °C (-452°F ... +302°F)	3 bottles each with 25 cm <sup>3</sup> (0.85 liquid ounce, US)	35 SGs	brush on with brush	Air-drying at room temperature	1 year	solvent-containing single-component nitrile rubber
<b>SG 250</b> Transparent Silicone rubber Order No.: 1-SG250	-70 °C ... +250 °C (-94°F ... +482°F)	Tube with 85 g (3.0 oz)	20 SGs	application from tube	room temperature	6 months	transparent, solvent free single-component silicone rubber
<b>PU 140<sup>(1)</sup></b> Polyurethane paint Order No.: 1-PU140	-40 °C ... +140 °C (-40°F ... +284°F)	3 bottles each with 30 ml (1.0 liquid ounce, US)	250 SGs	brush on with brush	room temperature ... + 80°C (... +176°F)	9 months	solvent containing single-component polyurethane paint
<b>SL 450</b> Transparent Silicone resin Order No.: 1-SL450	-50 °C ... +450 °C (-58°F ... +842°F)	3 bottles each with 25 g (0.9 oz)	90 SGs	brush on with brush	in temperature stages from 95°C to 315°C (203°F ... 599°F)	6 months	transparent, solvent containing silicone resin

<sup>(1)</sup> Caution: PU 140 and NG 150 cannot be combined



NG 150



SG 250

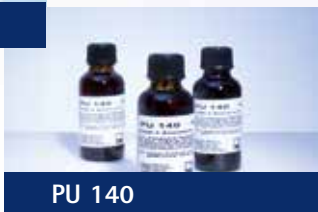

PU 140

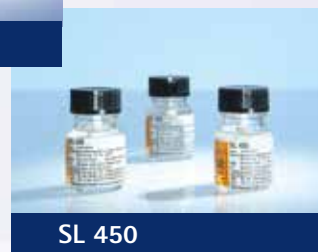

SL 450

## Chemical resistance of HBM covering agents

Chemical substance	AK 22	ABM 75	NG 150	SG 250	PU 140	SL 450
Weather conditions	Yes	Yes	Yes	Yes	Yes	Yes
Water:	Yes	Yes	Yes	Yes	Yes	Yes
Water under press. (400 bar (5,800 psi))	Yes	-	-	-	-	-
Condensation	-	-	-	-	Yes	-
Tropical climate	-	-	-	-	Yes	-
Water vapor	No	-	-	No	-	-
Oils:	No	No	Yes	Yes	Yes	-
Engine oil (RT/70°C (158°F))	-	-	Yes	-	-	-
Mineral oil (RT/70°C (158°F))	-	-	Yes	-	-	-
Hydraulic oil (RT/70°C (158°F))	-	-	Yes	-	-	-
Fats	-	-	-	-	Yes	-
Solvents general	No	Conditional	Conditional	No	-	Conditional
Fuels:	No	No	Yes	No	-	-
Petrol	No	No	Yes	No	-	-
Kerosene	-	-	Yes	-	-	-
Aromatic/Aliphatic mixtures	-	-	Conditional	-	-	-
Aromatic substances:	No	No	Conditional	No	No	No
Benzene	-	-	No	-	-	-
Toluene	No	No	Conditional	No	-	No
Xylene	No	No	Conditional	No	No	No
Chlorinated solvents:	No	No	No	No	No	No
Dichloromethane	No	No	No	No	No	No
Carbon tetrachloride	-	-	No	-	-	-
Perchloroethylene	-	-	No	-	-	-
1,2-Dichloroethane	-	-	No	-	-	-
o-Dichlorobenzene	-	-	No	-	-	-
Alcohols:	Conditional	Yes	Conditional	Conditional	No	Yes
Ethyl alcohol	Conditional	Yes	Conditional	Conditional	No	Yes
Methyl glycole	-	-	No	-	-	-
Butyl alcohol	-	-	Conditional	-	-	-
iso-propyl alcohol	-	-	Conditional	-	-	-
Ethylene glycole	-	-	Yes	-	-	-
Ketones:	Conditional	Conditional	No	No	No	Conditional
Acetone	Conditional	Conditional	No	No	No	Yes
Methyl ethyl ketone (MEK)	No	No	No	No	No	Conditional
Terpenes:	-	-	Conditional	-	-	-
Dipentenes	-	-	Conditional	-	-	-
Turpentine	-	-	Yes	-	-	-
Acids:	No	Conditional <sup>(1)</sup>	Conditional	Yes	No	Yes
Hydrochloric acid conc.	No	-	Conditional	Yes	No	Yes
Sulphuric acid 50 %	No	-	Yes	Yes	No	Yes
Acetic acid 50 %	No	-	No	Yes	No	Conditional
Nitric acid 50%	No	-	No	Yes	No	Yes
Oleic acid conc.	-	-	Yes	-	-	-
Laetic acid conc.	-	-	Conditional	-	-	-
Air containing acids	-	-	-	-	Yes	-
Alkalis:	Conditional	Conditional <sup>(1)</sup>	Conditional	No	Conditional	Yes
Sodium hydroxide 10 %	Conditional	-	No	No	No	Yes
Potassium hydroxide 10 %	-	-	No	-	-	-
Ammonia 28 %	-	-	Conditional	-	-	-
Air containing alkalis	-	-	-	-	Yes	-
Liquefied gases (excluding oxygen)	-	-	Yes	-	-	-
UV resistance	Yes	Yes	Yes	Yes	Yes	-

<sup>(1)</sup> Up to 5% (destruction of aluminum foil!)

Conditional = conditionally resistant (min. 10 days at RT)

### Chemical resistance

Unless identified specifically, the resistance refers to room temperature. No information can be provided on long term effects. The data is based on our own experience or was taken from literature. Since the specific conditions vary with each user, it is recommended that individual users carry out their own tests on resistance. Some covering agents become milky when in contact with some chemicals.

# Cleaning agents, gluing and soldering materials

## Cleaning agent RMS1

Environmentally-friendly solvent mixture that dissolves all normal contamination. One packing unit contains 1 l cleaning agent and 450 cleaning pads.

Order No.: 1-RMS1

## Cleaning agent RMS1 SPRAY

Environmentally-friendly solvent mixture. Contains 5 spray cans with 200 ml cleaning agent each and 450 cleaning pads.

Order No.: 1-RMS1-SPRAY

## Fluoropolymer release film

33 m (108.27 ft) fluoropolymer release film on reel, suitable for cold and hot curing strain gauge bonding. The fluoropolymer release film prevents other material except the strain gauge from bonding to the component.

Thickness: 0.05 mm (0.000164 inch), width: 60 mm (0.197 inch)

Temperature application range: -200°C to +260 °C (-328°F to 500°F).

Order No.: 1-RELEASEFILM

## Flux pen

Soldering aid in felt pen format for production of smaller soldering connections. Suitable for solders with melting points up to 350 °C (662°F). The flux pen contains non-corrosive flux without chloride.

Package contents: 5 pcs.

Order No.: 1-FS01

## Polyimide tape

33 m (108.27 ft) heat resistant tape, 19 mm (0.748 inch) wide, ca. 70 µm (2756 microinch)

total thickness.

Temperature application range: -70°C to +260 °C (-94°F to 500°F).

Order No.: 1-KLEBEBAND

## Cleaning pads

Cellulose pads for cleaning test objects before strain gauge installation. Format 5 cm x 5 cm (1.967 x 1.967 inch).

Package contents: 450 pcs

Order No.: 1-8402.0026

## Cleaning agent dispenser

In order to avoid contamination of the solvent over time, we recommend using the RSP 120 cleaning agent dispenser.

Order No.: 1-RSP120



Cleaning agent RMS1 SPRAY



Flux pen



Cleaning agent dispenser

# Soldering terminals

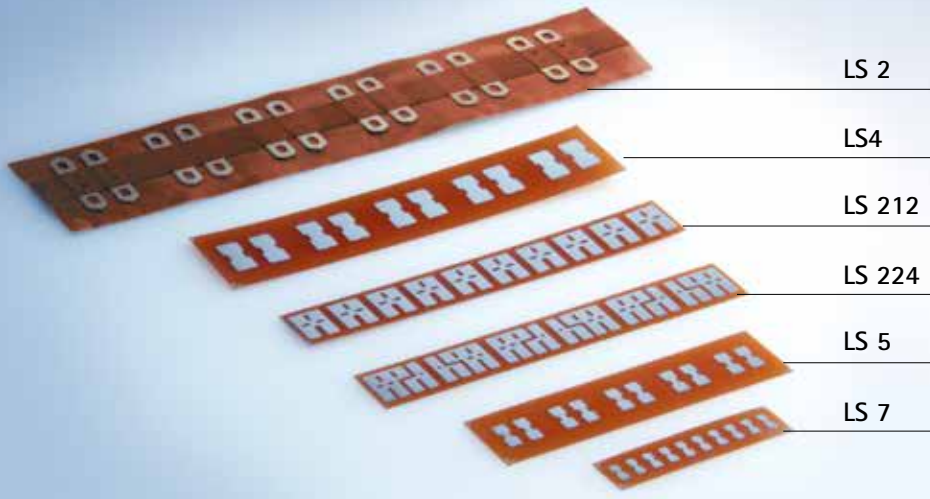

For strain gauges with leads or wires, solder terminals should be installed between the connecting cables and the strain gauge itself. This will facilitate the execution of a perfect solder joint and provide strain relief for the SG connections. The solder terminals are installed in the same way on the test object as on the SG. HBM offers solder terminals in various designs and dimensions.

## LS2

Bronze soldering tag on polyimide carrier suitable for dynamic loads  
Attachment to test object: Bonding  
Can be used up to 180°C (356°F), briefly up to 260°C (500°F)

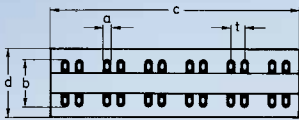

Product number	Dimensions (mm/inch)				Distance t	Contents per package:
	Solder tag		Carrier			
	a	b	c	d		
1-LS 2	2.6 0.102	13.5 0.531	72 2.835	20 0.787	4 0.157	36 pairs (6 strips)

## LS7/5/4

Copper, nickel-plated, on polyimide  
Attachment to test object: Bonding  
Can be used up to 180°C (356°F), briefly up to 260°C (500°F)

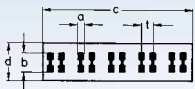

Product number	Dimensions (mm/inch)				Distance t	Contents per package:
	Solder tag		Carrier			
	a	b	c	d		
1-LS 7	1 0.039	3 0.118	21 0.827	6 0.236	2 0.079	125 pairs
1-LS 5	1.5 0.059	4.5 0.177	35 1.378	10 0.394	2.5 0.098	125 pairs
1-LS 4	2.5 0.098	6.5 0.256	50.1 1.972	13 0.512	4 0.157	125 pairs (25 strips each)

## LS212

Copper, nickel-plated on polyimide  
Attachment to test object: Bonding  
Can be used up to 180°C (356°F), briefly up to 260°C (500°F)

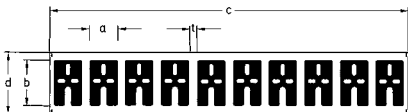

Product number	Dimensions (mm/inch)				Distance t	Contents per package:
	Solder tag		Carrier			
	a	b	c	d		
1-LS 212	3.7 0.146	6 0.236	47.5 1.870	8 0.315	1 0.039	125 pairs (25 strips)

## LS224

Copper, nickel-plated, on polyimide  
Attachment to test object: Bonding  
Can be used up to 180°C (356°F), briefly up to 260°C (500°F)

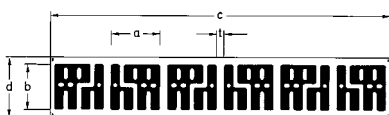

Product number	Dimensions (mm/inch)				Distance t	Contents per package:
	Solder tag		Carrier			
	a	b	c	d		
1-LS 224	6.5 0.256	6 0.236	45 1.772	8 0.315	1 0.039	150 pairs (25 strips)

# Cables and stranded wires

## PVC flat ribbon cable

PVC insulated flat ribbon cable, consisting of 6 wires with a cross-section of 0.14 mm<sup>2</sup> (0.0002 sq. in.) each, 50 m (164 ft) per roll, resistance 0.131 Ω/m (0.04 Ω/ft).

Order No.: 1-3133.0034

## Paint-insulated copper wire

Polyurethane-insulated copper wire with a cross-section of 0.04 mm<sup>2</sup> (6.2 · 10<sup>-5</sup> sq. in.), 25 m (82 ft) long.

Order No.: 1-CULD01

## Jumper wire

Fluoropolymer-insulated jumper wire with a cross section of 0.05 mm<sup>2</sup>, (7.75 · 10<sup>-5</sup> sq. in.), yellow, 100 m (328 ft) per reel, resistance 0.34 Ω/m (0.104 Ω/ft).

Order No.: 1-3130.0239-G

## Very flexible stranded wire

for internal, exposed wiring of transducers;

cross-section 0.04 mm<sup>2</sup> (6.2 · 10<sup>-5</sup> sq. in.) (multi-wire), 0.6 mm (0.024 inch) external diameter, resistance 0.417 Ω/m (0.127 Ω/ft), permissible temperature + 70°C (158°F), 25 m (82 ft) per reel, PVC insulation.

Order No.: 1-SLI 01

## Flexible stranded wire

Fluoropolymer-insulated flexible stranded wire with a cross-section of 0.24 mm<sup>2</sup> (0.0004 sq. in.) (multi-wire), external diameter of 0.9 mm (0.035 inch), 100 m (328.08 ft) per roll, resistance 0.0741 Ω/m (0.023 Ω/ft).

blue Order No.: 1-3301.0092-B

black Order No.: 1-3301.0088-S

green Order No.: 1-3301.0091-GR

red Order No.: 1-3301.0089-R

white Order No.: 1-3301.0094-W

Designation	Insulation	Thermal resistance	Chemical resistance	Typ. application
<b>Flexible stranded wire</b> 1-3301.0088-S 1-3301.0089-R 1-3301.0091-GR 1-3301.0092-B 1-3301.0094-W	Fluoropolymer	-200 ... +260°C (-328°F ... +500°F)	Not resistant against: elementary fluoride, chlorine trifluoride, molten Alkali metals. Otherwise resistant against all chemicals	for internal connection of SG bridges or for connection from SG to solder terminal point
<b>Jumper wire</b> 1-3130.0239-G	Fluoropolymer	-200 ... +260°C (-328°F ... +500°F)	See flexible stranded wire	See flexible stranded wire
<b>Very flexible stranded wire</b> 1-SLI 01	PVC	Briefly 105°C (221°F) Continuous ... 70°C (... 158°F)	Not resistant against: Esters, chlorinated hydrocarbons ketones, aromatics, benzene, liquid halogens, conc. nitric acid, aqueous solutions depending on the plasticizer	for internal connection of SG in transducer
<b>PVC flat ribbon cable</b> 1-3133.0034	PVC	Briefly 105°C (221°F) Continuous ... 90°C (194°F)	See very flexible stranded wire	See flexible stranded wire
<b>Paint-insulated copper wire</b> 1-CULD 01	Polyurethane	Briefly 120°C (248°F) Continuous -40...80°C (-40°F ... +176°F)	Not resistant against: strong acids, strong alkalis Alcohols, aromatics, saturated vapor, hot water	for internal connection of SG in transducer

## Shielded measurement cable

Type	Kab4.1/00-3	Kab5/00-4	Kab8/00-4	Kab7/00-4	Kab9/00-4
Notes	Inexpensive cable for connecting 1/4 bridges in 3-wire circuits (CF 600Hz <50m (164 ft); CF 4.8kHz <20m (65 ft))	Reduced capacitance, therefore also suitable for CF amplifiers and longer distances. Very thin, therefore predestined for geometrically critical conditions	Very reduced capacitance cable with low resistance, therefore suitable for longer distances	Wide temperature range and good chemical resistance. When using CF amplifiers, the applicable cable length is restricted (CF 600Hz <50m (164 ft); CF 4.8kHz <20m (65 ft))	Like KAB7/00-4, but with smaller resistance, therefore greater range for lower-frequency CF or DC amplifiers
Sheath color	gray	gray	gray	gray	gray
No. of cores	3	4	4	4	4
Outside diameter [mm (inch)]	4.1 (0.161)	5 (0.197)	8 (0.215)	6.5 (0.256)	8.8 (0.346)
Core cross-section [mm (inch)]	0.14 (0.006)	0.17 (0.007)	0.26 (0.010)	0.5 (0.020)	1.25 (0.049)
Insulation material (core)	PVC	PE	PE	Fluoropolymer	Fluoropolymer
Sheath material	PVC	PVC	PVC	Silicone	Silicone
Resistance [ $\Omega$ /m ( $\Omega$ /ft)]	0.130 (0.04)	0.106 (0.305)	0.075 (0.0229)	0.040 (0.0122)	0.014 (0.00427)
Insulation resistance (core-core) [ $\Omega$ /m ( $\Omega$ /ft)]	$10^{12}$ (0.305 · $10^{12}$ )	$10^{12}$ (0.305 · $10^{12}$ )	$10^{12}$ (0.305 · $10^{12}$ )	$10^{12}$ (0.305 · $10^{12}$ )	$10^{12}$ (0.305 · $10^{12}$ )
Capacitance (core-core) [pF/m]	110 (33.5 pF/ft)	80 (24.4 pF/ft)	67 (20.4 pF/ft)	140 (42.7 pF/ft)	140 (42.7 pF/ft)
Capacitance (core-shield) [pF/m]	110 (33.5 pF/ft)	80 (24.4 pF/ft)	67 (20.4 pF/ft)	140 (42.7 pF/ft)	140 (42.7 pF/ft)
Temperature range [ $^{\circ}$ C ( $^{\circ}$ F)]	-20 ... 80 (-4 ... +176)	-35 ... 80 (-31 ... +176)	-35 ... 80 (-31 ... +176)	-50 ... 180 (-58 ... +356)	-50...180 (-58 ... +356)
1/4 bridges in 3-wire circuit, full bridges without sensing lead connected	x	x	x	x	x
1/4 bridges in 4-wire circuit, full bridges without sensing lead connected	x	x	x	x	x
Half bridges; full bridges with sensing lead connected					
Order number	4-3131.0017	4-3133.0002	4-3133.0023	4-3131.0048	4-3131.0012

Minimum order quantity: 10 m (32.8 ft)

Further information can be found in the price list (load cells, transducers, amplifiers, data acquisition and software)

Kab5.4/00-6	Kab6.5/00-6-TPE	Kab6.5/00-6-SIL	Kab4.2/00-6-PUR	Kab8/00-2/2/2	Kab8/00-2/2/2 SIC
Inexpensive 6-wire cable for uncritical applications (CF 600Hz <50m (164 ft); CF 4.8kHz <20m (65 ft))	Like Kab5.4/00-6, but with extended temperature range	Chemically resistant cable with extended temperature range. Also suitable for longer distances due to reduced capacitance and resistance	Special cable for use in the soil (CF 600Hz <50m (164 ft); CF 4.8kHz <20m (65 ft))	Quad-shielded cable twisted in pairs, also suitable for longer distances and higher-frequency CF amplifiers	Like Kab8/00-2/2/2, but better chemical resistance
gray	gray	gray	black	gray	gray
6	6	6	6	6	6
5.4 (0.213)	6.5 (0.256)	6.5 (0.256)	4.2 (0.165)	7.5 (0.295)	7.5 (0.295)
0.14 (0.006)	0.25 (0.010)	0.25 (0.010)	0.15 (0.006)	0.14 (0.006)	0.14 (0.006)
PE	TPE	Fluoropolymer	TPE	PE	PE
PVC	TPE	Silicone	PUR	PVC	Silicone
0.130 (0.04)	0.077 (0.0235)	0.080 (0.0244)	0.120 (0.0366)	0.138 (0.0421)	0.138 (0.0421)
$10^{12}$ (0.305 · 10 <sup>12</sup> )	$10^{12}$ (0.305 · 10 <sup>12</sup> )	$10^{12}$ (0.305 · 10 <sup>12</sup> )	$10^{12}$ (0.305 · 10 <sup>12</sup> )	$10^{12}$ (0.305 · 10 <sup>12</sup> )	$10^{12}$ (0.305 · 10 <sup>12</sup> )
82 (25 pF/ft)	100 (30.5 pF/ft)	100 (30.5 pF/ft)	95 (42.7 pF/ft)	75 (22.9 pF/ft)	75 (22.9 pF/ft)
82 (25 pF/ft)	100 (30.5 pF/ft)	100 (30.5 pF/ft)	140 (42.7 pF/ft)	130 (39.6 pF/ft)	130 (39.6 pF/ft)
30... 85 (-22 ... +185)	50 ... 120 (-58 ... +248)	-50 ... 180 (-58 ... +356)	-50 ... 125 (-58 ... +257)	-30 ... 70 (-22 ... +158)	-30 ... 70 (-22 ... +158)
x	x	x	x	x	x
4-3131.0071	4-3301.0115	4-3301.0108	4-3301.0151	4-3301.0071	4-3301.0169

# Bridge completions/resin-cored solder/lead-free solder

## Bridge completions

Bridge completion resistors are connected to the strain gauges of a measuring point to form the Wheatstone bridge circuit. In accordance with the nominal strain gauge resistances, HBM offers various resistance values.

2 x 120  $\Omega$  Order No.: 3-3054.0334

2 x 350  $\Omega$  Order No.: 3-3054.0282

## Resin-cored solder

Resin cored solder for SG applications. Soldering wire  $\varnothing$  0.5 mm (0.019 inch), consisting of cored solder SN60Pb38Cu2 with resin core type F-SW32. The flux is non-corrosive.

Melting range: 183 ... 190°C (361.4°F ... 374°F). Delivery form: 1 kg (2.2 lb) on reel

Order No.: 1-LOT

## Lead-free solder

Lead-free resin cored solder for SG applications. Diameter: 0.5 mm (0.02 inch); Sn95, 5Ag3, 8Cu0,7 ("no clean").

Melting range: 217°C to 219 °C (422.6°F to 426.2°F). Delivery form: 500 g on reel

Order No.: 1-LOT-LF





# SG installation case

## SG Starter Kit DAK 1

This handy case contains all the equipment needed for installing strain gauges for the first time. It provides an easy introduction to strain gauge technology. Comprehensive know-how around installation and wiring of strain gauges, and evaluation of measured values is provided by the specialized book written by Karl Hoffmann, an experienced specialist in strain gauge technology.

For the first practical steps, containing:

- Strain gauges
- Solder terminals
- Cleaning agents and cleaning pads
- Emery cloth
- Cold-curing adhesives X60 and Z70
- Stranded connection wires
- 2 agents for measuring point protection: AK22 and ABM75

Because DAK1 has been used for many years in company-internal SG and instrumentation seminars, the contents have been continuously optimized.

Order No.: 1-DAK1



### DAK 1 contents

10	SG LY11-6/120A
1	Z 70
1	X 60
1	AK 22
1	ABM 75
	Soldering terminals
	Stranded connection wires
	Emery cloth
	RMS 1
	Cleaning pads
	Solder
1	Petri dish
1	Specialist book: "Eine Einführung in die Technik Messens mit Dehnungsmessstreifen" (An introduction to strain gauge measurement technology)

## SG installation case DAK 2

The DAK 2 strain gauge installation case contains all tools and aids required for strain-gauge installations. It is portable and lockable. In the bottom part of the DAK 2 there is space for various adhesives and other uses, below the removable insert.

Dimensions: 470 x 170 x 360 mm (18.50 x 6.69 x 14.17 inch)

Weight: Approx. 6 kg (13.23 lb)  
(incl. standard scope of delivery)

Order No.: 1-DAK2

### AK 2 contents

1	Ersa soldering iron (16 W)	1	Scalpel holder plus 6 blades
1	Flat brush	10 m (32.8 ft)	Flat ribbon cable 6 x 0.14 mm <sup>2</sup> , various colors
1	Folding magnifying glass (6x)	25 g (0.88 oz)	Soldering wire Ø 1 mm
1	Graduated ruler, 150 mm (5.91 inch)	1	Flux pen
1	Glass fiber erasing brush, plus 1 spare brush	1	Roll of Scotch tape
1	Scissors, toothed	1	Rubber
1	Pointed scissors	1	HBM ballpoint pen
1	Tweezers, wide	1	each corundum cloth sheets, grain size 180/220/360
1	Tweezers, pointed	100 cm <sup>3</sup> (3.38 liquid ounce, US)	Cleaning agent RMS 1
1	Flexible ruler, 300 mm (11.81 inch)	200	Cleaning pads, 50 x 50 mm (1.97 x 1.97 inch)
1	Dental probe with bent tip		
1	Cement spatula		
1	Cutting and stripping pliers		
1	Petri dish 60/15		

# The right solutions for your measurement tasks

Every measurement task has its own characteristics and requirements. Meeting these demands is our challenge. With the right amplifiers, optimized for your needs.



## Universal and compact – MX1615 from the QuantumX family

MX1615 is the future-proof solution for your measurements. Due to its compactness and universality, this amplifier meets all requirements for experimental stress analysis in just one module.

- 16 individually configurable synchronous inputs for measurements using SG and active transducers, as well as PT100 for temperatures
- Carrier frequency for maximum accuracy or direct voltage for dynamic measurement of up to 20 kHz per channel
- Flexible adaptation to the measurement environment through centralized or distributed topology
- Modular expansion for the acquisition of additional mechanical or digital measured quantities

## Scalable and versatile – MGCplus

The modular amplifier concept. The perfect combination for every measurement task. Force, displacement or temperature: MGCplus is the universal amplifier system. It is already equipped for future measurement tasks thanks to its numerous upgrade options.

- Flexible adaptation to individual measurement tasks due to the modular structure
- Minimization of line influences due to the patented, expanded Kreuzer circuit
- Stand-alone functionality due to display and control panel
- Established measurement system, highly regarded in the market. More than 200,000 channels sold so far



### Efficient and cost-saving – CANHEAD

Expensive kilometers of connection cables are usually required when numerous measuring points are used. However, CANHEAD amplifier modules are decentrally connected, close to the SG using standard cables. This reduces installation costs by up to 90 percent.

- Reduction of costs and outlay for cabling
- Cost-effective acquisition of many SG measuring points
- 10 channels available per device, up to 12 CANHEAD per data cable



### Noise-immune, currentless measurement – Optoelectric measurement equipment

The HBM optical measurement chain starts where other conventional technologies meet their limits. High strains, strong electromagnetic loads and highly explosive conditions pose no problem for optical measurement.

- Efficient material utilization through bundling of up to 13 optical SG per fiber and connection
- Easy expansion of the system with up to 16 connections through optical multiplexers
- Meaningful acquisition of strains with up to 1,000 measurements per second

# From preparation to post-processing. For complete measurement data

Whether you want to configure a measurement system or simply acquire and display measurement data. Whether you want to analyse data and derive results or simply want reporting. Your requirements are our incentive.

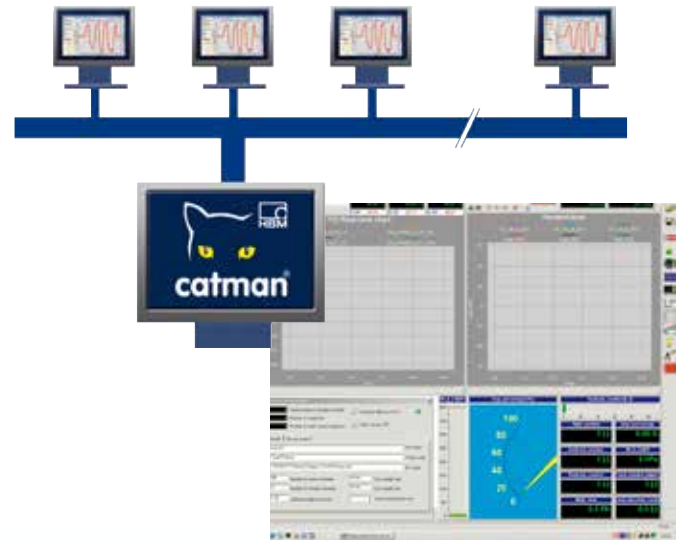

## catman®AP

The intuitive software for acquiring and displaying measured data

- Rapid measurement results
- Simple operation through intuitive design
- Free definition of graphical user interfaces
- Mathematics library for experimental stress analysis



## catman® Enterprise

The software for easy handling of multi-channel measurement tasks

- Up to 20,000 channels can be configured with ease
- Common measured data utilization through Client/Server architectures
- Comprehensive trigger functions
- Trend analyses for fatigue tests

We cannot see the future.  
But we can calculate it.

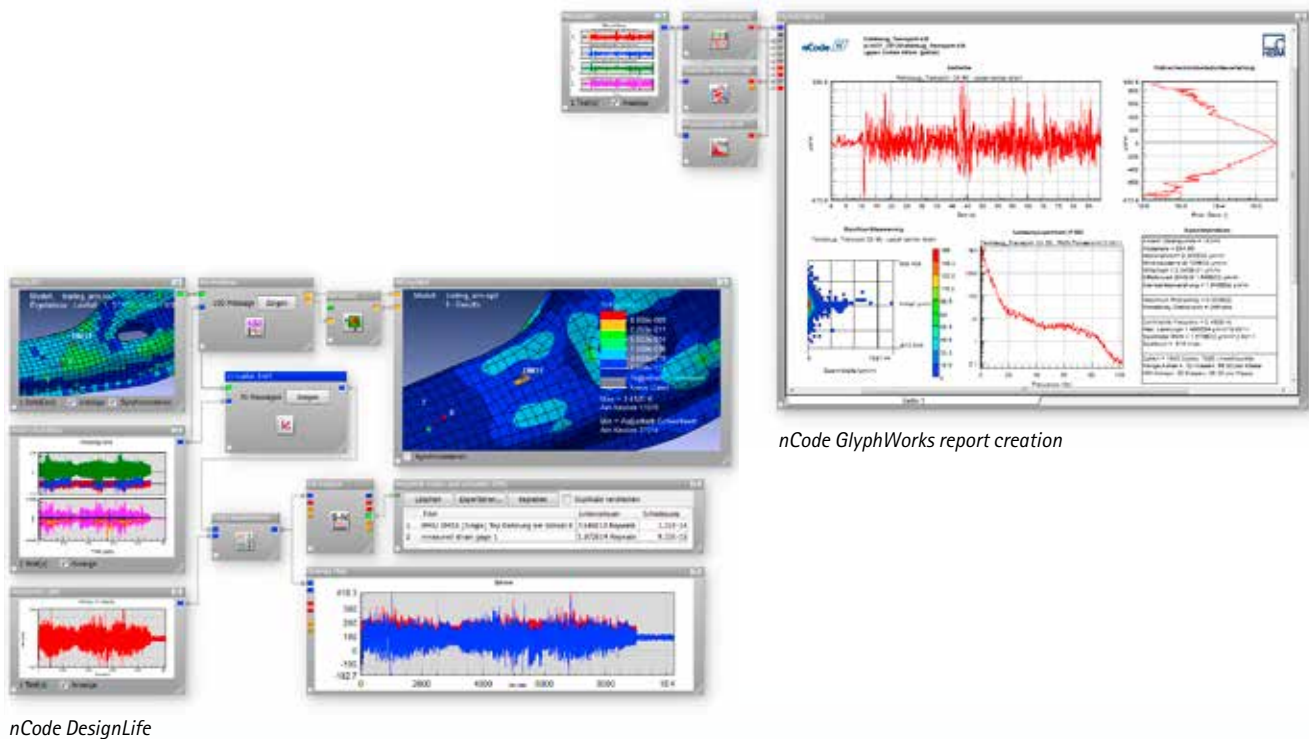

**nCode** *n'*

From simulation to analysis. nCode is the professional software for the structural durability of your products. You can make more of your measurement data with the products nCode GlyphWorks, nCode DesignLife and nCode Automation.

- Reduction in development time through forecasting and simulation of operational stability right from the concept phase
- Verification of calculated data through meaningful service life analyses based on real measurement data
- Rapid and reproducible evaluation due to graphical and process-oriented user interface
- Higher productivity through One-Click report creation

# Optical strain gauges – measurement with light, based on fiber Bragg gratings



Measure stress on components and in environments where conventional technologies are coming up against their limits – using HBM's optical measurement chain.

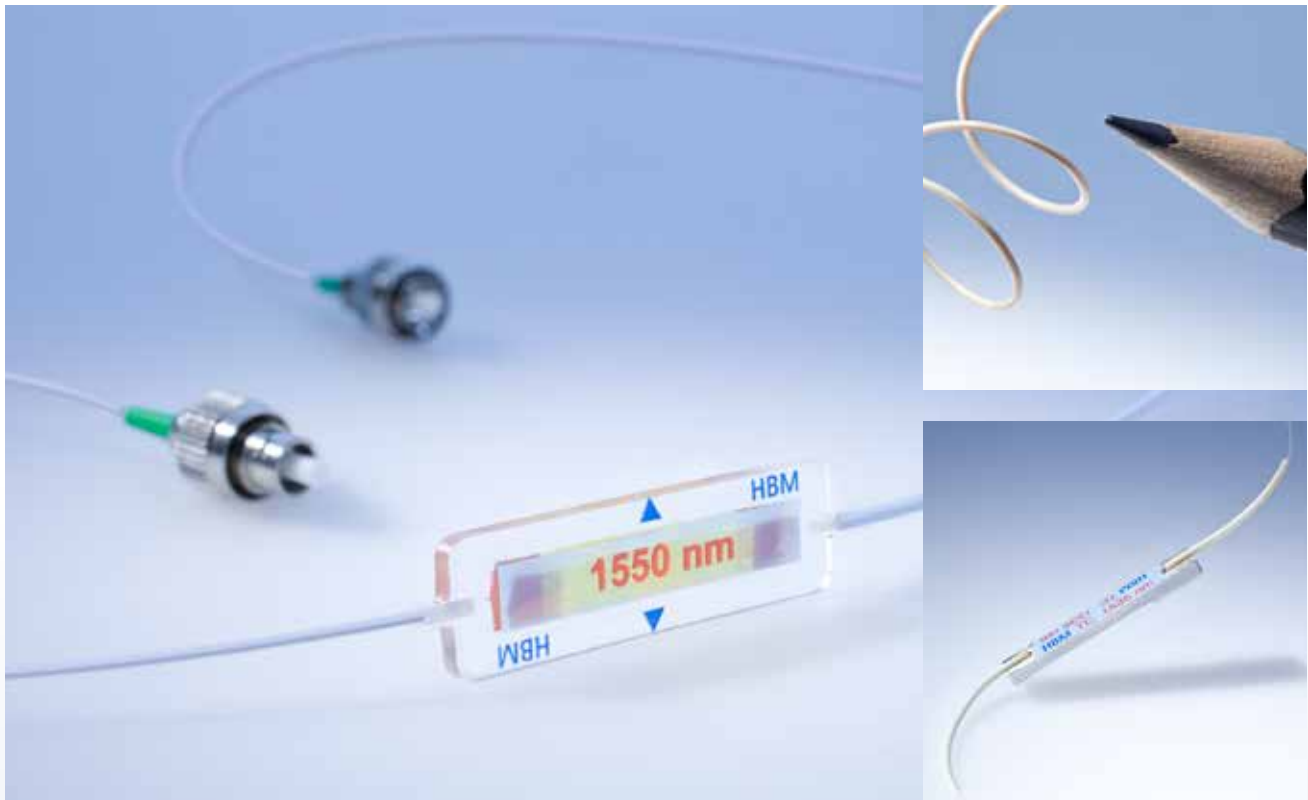

## Special features:

- Insensitive to electromagnetic interference
- Use in potentially explosive environments
- High stability against alternating load (10 million load cycles at  $\pm 5,000 \mu\text{m/m}$ )
- Up to 13 optical strain gauges per glass fiber
- Easy installation, similar to electrical strain gauges
- Freely configurable measurement chain

## Components of the optical measurement chain:

- K-OL Linear optical strain gauge
- K-OR Optical rosette for measuring strain in three directions
- K-OTC Optical temperature sensor for temperature compensation
- OptiMet Flexible and rugged optical fiber
- Accessories Everything you need for the optical strain gauge (adhesive, optical couplings, splicing technology, etc.)

For more information, go to:  
[www.hbm.com/optics](http://www.hbm.com/optics)

# Seminars

Learning by rote is not our style. HBM offers you practical basic and advanced training in the field of the electrical measurement of mechanical quantities. The basics in this field will first be explained and demonstrated by means of hands-on lectures. Subsequent practical training will follow. Theory and practice sessions alternate several times during the course of the seminar, in order to discuss and clarify questions - which usually first occur in practical application sessions - in the next theory block.

Our seminar concept offers the right seminar for everybody - ranging from the free one-day lecture through workshops up to 1-week seminars.

## DK

Basics of strain gauge bonding and measuring technology

Target group: Specialist personnel, master tradesmen or engineers who want to implement SG installations independently.

## DM

Strain gauge measuring technology in transducer construction and experimental stress analysis

Target group: Users from all specialist disciplines who want to carry out measurements with strain gauges.

For more detailed information on our seminars on HBM device technology and software and all seminar dates, please visit our homepage at [www.hbm.com](http://www.hbm.com). Or request our seminar program from [seminare@hbm.com](mailto:seminare@hbm.com).

It is of course possible to implement all seminars that are offered in our seminar center at Darmstadt directly on your own premises.

On request, we can modify our seminars in order to enable us to offer you target-oriented basic and advanced training.



# Literature

SG specialized book

## "An introduction to measurement using strain gauges"

A practical introduction into this specialist area of measurement technology with a focus on how to avoid or correct measuring errors.

Order No.: 1-Hoffm. Buch-D (deutsch)

1-Hoffm. Buch-E (English)

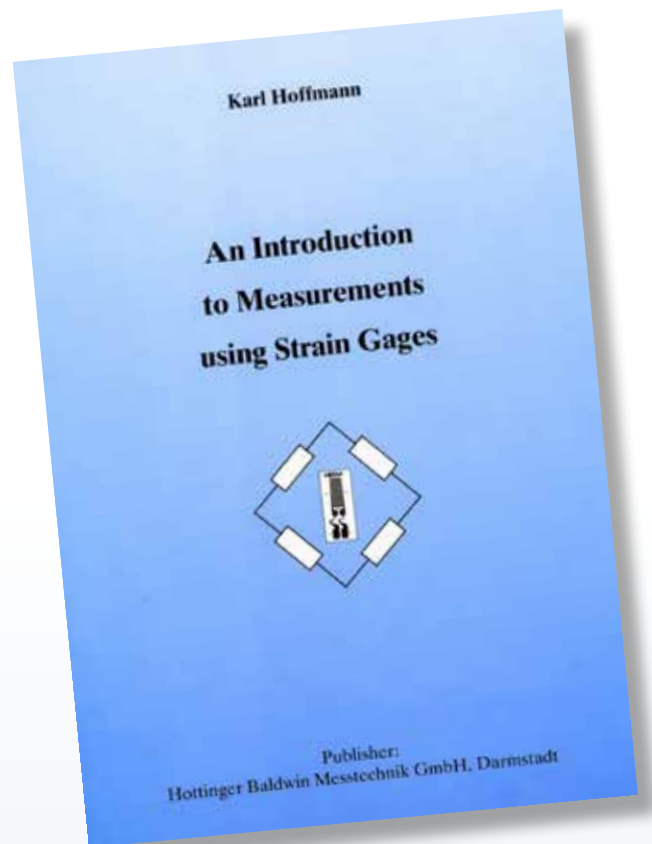





© Hottinger Baldwin Messtechnik GmbH. All rights reserved.  
All details describe our products in general form only.  
They are not to be understood as express warranty and do  
not constitute and liability whatsoever.

[www.hbm.com](http://www.hbm.com)

**HBM Test and Measurement**

Tel. +49 6151 803-0  
Fax +49 6151 803-9100  
[info@hbm.com](mailto:info@hbm.com)

**US Contact**

HBM, Inc.  
Tel. +1 (800) 578 4260  
[info@usa.hbm.com](mailto:info@usa.hbm.com)

measure and predict with confidence

